



Product Map  
Table of Contents



2024 SA Ariba Sourcing Project : WS3472349042,  
Ariba Master Agreement CW2240515

Price Guide 2024

# Thank you for choosing BRC

Established in 1979 and incorporated in 1983, BRC Group has grown into a leader in the research, development and manufacturing of high quality ergonomic office furniture. BRC is a Canadian-owned private company with modern manufacturing facilities in Georgetown, Ontario, Canada.

BRC is a forerunner in blending environmental initiatives with the manufacturing of renewable and recyclable products. BRC uses materials and manufacturing processes which virtually eliminate Volatile Organic Chemical (VOC) emissions in the office environment. Raw materials are responsibly sourced, assuring that only the best and most sustainable components are converted to finished goods. BRC is committed to developing and offering the best-value products for the middle and higher end markets.

From OEM solutions to obscure designer requests to simply striving to be better, BRC provides creative and innovative customized solutions to complement any environment and use. Flexible manufacturing offers the ability for BRC to respond to client's special needs rather than having standard catalogue solutions. A wide collection of textiles, laminate finishes and wood veneer allows companies and individuals to express their brand and culture through a unique signature look.

All furniture is designed and manufactured to meet or exceed ANSI-BIFMA standards. Standard construction uses a combination of 3/4" and 1" material with metal to metal commercial grade connections for solid enduring assembly. The newest edge banding technology, in which the edge tape is melted directly to the edge of the board, enables BRC to manufacture products with virtually invisible glue lines.

The BRC Team works hard to earn and keep your business - our success depends on it. If you have any questions or inquiries, please contact us at [info@brc.group](mailto:info@brc.group) or toll free at 1-877-260-4309.

We appreciate your business and look forward to hearing from you.

## Warranty, Terms & Conditions

BRC is pleased to offer one of the most competitive warranties in the industry. All furniture products carry a 12 year limited structural warranty. BRC furniture panel and table electrical cabling carry a 3 year limited warranty. All moving user adjustable components carry a 5 year limited structural warranty. All other electrical or electronic elements of BRC furniture carry a 1 year limited warranty.

For full warranty details, terms and conditions, please visit [www.brc.group/warranty](http://www.brc.group/warranty)



# Guidance & Ordering

PRODUCT IMAGE

PRODUCT DESCRIPTION

FEATURES

Dual Power, Dual USB

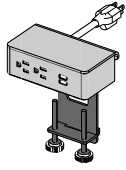

210 CLAMP ON

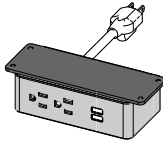

210 UNDERMOUNT

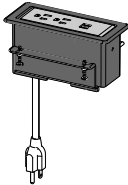

DUO FLUSH MOUNT

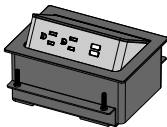

TILT FLUSH MOUNT

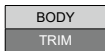

ACCESSORIES PRICE GUIDE 2021 R2

AC2AE	
FEATURES & SPECIFICATIONS	PRICE
<ul style="list-style-type: none"> <li>• Double outlet</li> <li>• Two USB ports</li> <li>• 72" Corded plug</li> <li>• Finish options: Trim: black, silver or white Body: white, grey, black, orange, red, green, blue</li> </ul>	623

AU2AE	
FEATURES & SPECIFICATIONS	PRICE
<ul style="list-style-type: none"> <li>• Double outlet</li> <li>• Two USB ports</li> <li>• 72" Corded plug</li> <li>• Finish options: Trim: black, silver or white Body: white, grey, black, orange, red, green, blue</li> </ul>	573

AF2AE	
FEATURES & SPECIFICATIONS	PRICE
<ul style="list-style-type: none"> <li>• Double outlet</li> <li>• Two USB ports</li> <li>• 72" Corded plug</li> <li>• Finish options: Trim: black, silver or white Body: white, grey, black, orange, red, green, blue</li> </ul>	583

AT2FE	
FEATURES & SPECIFICATIONS	PRICE
<ul style="list-style-type: none"> <li>• Double outlet</li> <li>• Two USB ports</li> <li>• 72" Corded plug</li> <li>• Finish options: Trim: black, silver or white Body: white, grey, black, orange, red, green, blue</li> </ul>	996

▽

ORDER CODE SAMPLE		
ITEM CODE	TRIM	BODY
AF2AE	BLACK	GREY

CATALOG REVISION

ORDER CODE SAMPLE

PRODUCT MAP
ELECTRICAL
WIRE MANAGEMENT
UNDER DESK STORAGE
TASK LIGHTS
DESK SCREENS
CONTROLLER
GROMMETS
KEYBOARD COMBOS
KEYBOARD HOLDERS
MONITOR ARMS
KEYS
HOOKS

LIST PRICE

HYPERLINK TO OTHER ITEMS WITHIN DOCUMENT

# Table of Contents

Welcome	2	<b>Products</b>	
Guidance and Ordering	3	Single Power, Dual USB	6
Contents	4	Dual Power, Dual USB	7
Product Map	5	Three Power, Dual USB	8
		Top Mount Tilting Power Modules	9
		Interact G2 Power Module	10
		Interact IV G2 Power Module	11
		Interface G2	12
		Surface Mount Power & Dual USB	13
		Pop-Up Wireless Charger with 2 USB	14
		Pop Up- Power Station	15
		Villa Undermount	16
		Power Bars	17
		Modesty Panel	18
		Wire Management	19
		Desk Storage	21
		Task Lights	22
		Desk Screens	24
		Grommets	26
		Keyboard Combos	28
		Keyboard Platforms	29
		Keyboard Mechanisms	30
		Keyboard Accessories	31
		CPU Holders	32
		Monitor Arms	34
		Flat Brackets	38
		Drawer Box	39
		File Hanger Bars	40
		Keys & Cores	41
		Handles	43
		Casters	44
		Levellers	45

PRODUCT MAP
ELECTRICAL
WIRE MANAGEMENT
UNDER DESK STORAGE
TASK LIGHTS
DESK SCREENS
CONTROLLER
GROMMETS
KEYBOARD COMBOS
CPU HOLDERS
MONITOR ARMS
KEYS
HOOKS
BRACKETS

# Product Map

## Electrics and Power Modules

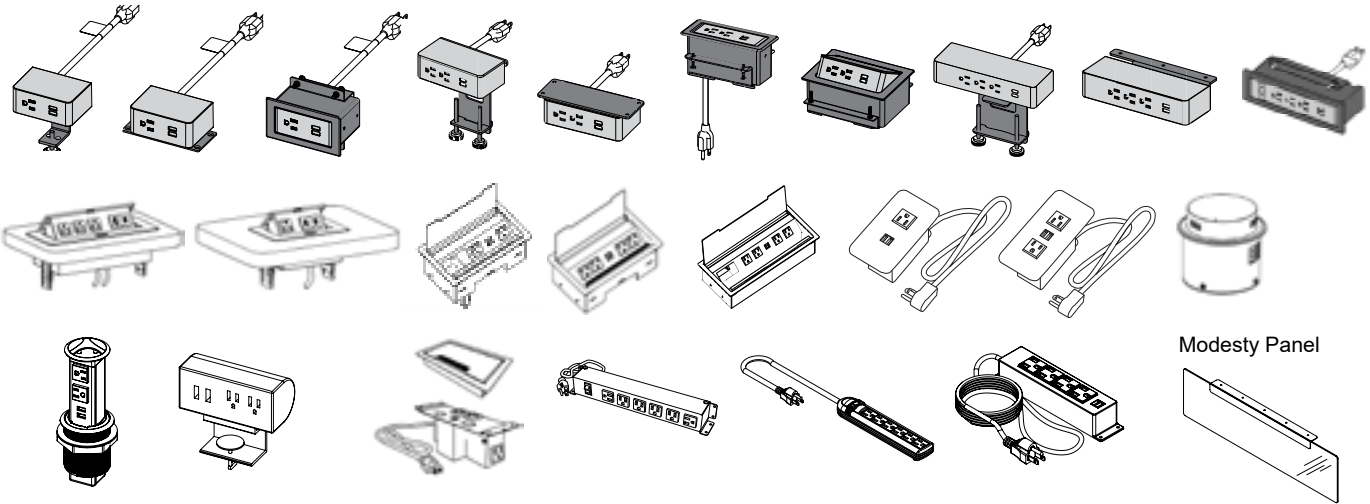

Modesty Panel

## Wire Management



## Under Desk Storage

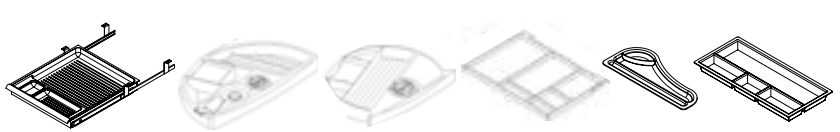

## Task Lights



LED

T5 Fluorescent

Desk Light

## Desk Screens

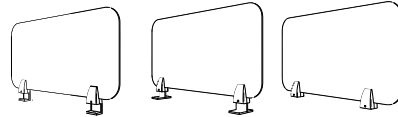

## Controller Options



## Grommets

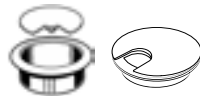

## CPU Holders

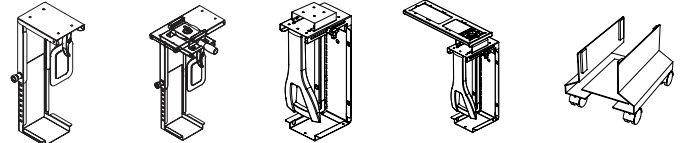

## Keyboard Combos

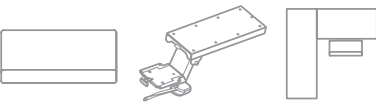

## Keyboard Platforms

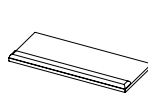

## Keyboard Mechanisms, Corner and Spacers

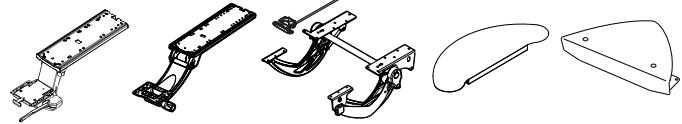

## Ventilation Grills

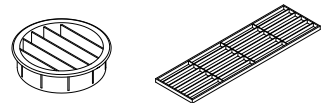

## Keys



## Hooks

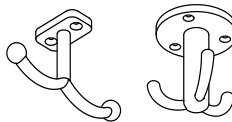

## Monitor Arms & TV Mounts

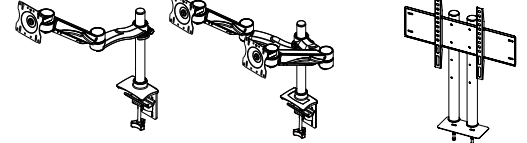

## Parts & Pieces

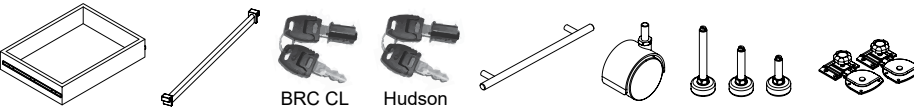

BRC CL

Hudson

## Brackets

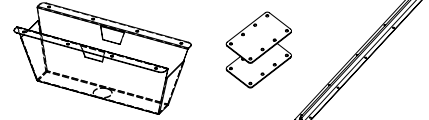

# Single Power, Dual USB

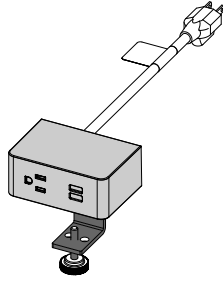

**UNO CLAMP ON**

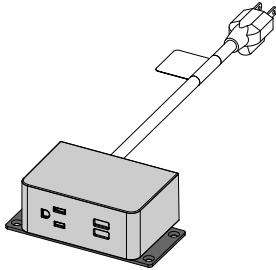

**UNO UNDERMOUNT**

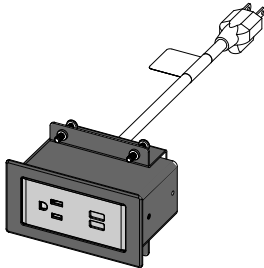

**UNO FLUSH MOUNT**

BODY
TRIM

AC1AE	
FEATURES & SPECIFICATIONS	PRICE
<ul style="list-style-type: none"> <li>• Single outlet</li> <li>• Two USB ports</li> <li>• 72" Black corded plug</li> <li>• Finish options: Trim: black, silver or white Body: white, grey, black, orange, red, green, blue</li> </ul>	573

AU1AE	
FEATURES & SPECIFICATIONS	PRICE
<ul style="list-style-type: none"> <li>• Single outlet</li> <li>• Two USB ports</li> <li>• 72" Black corded plug</li> <li>• Finish options: Trim: black, silver or white Body: white, grey, black, orange, red, green, blue</li> </ul>	541

AF1AE	
FEATURES & SPECIFICATIONS	PRICE
<ul style="list-style-type: none"> <li>• Single outlet</li> <li>• Two USB ports</li> <li>• 72" Black corded plug</li> <li>• Finish options: Trim: black, silver or white Body: white, grey, black, orange, red, green, blue</li> </ul>	574



ORDER CODE SAMPLE		
ITEM CODE	TRIM FINISH	BODY FINISH
AU1AE	SILVER	WHITE

# Dual Power, Dual USB

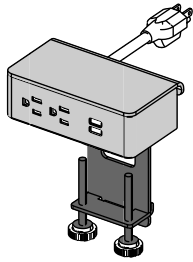

**210 CLAMP ON**

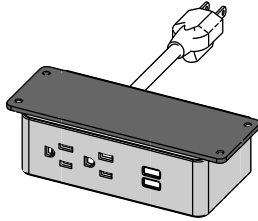

**210 UNDERMOUNT**

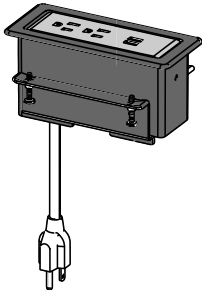

**DUO FLUSH MOUNT**

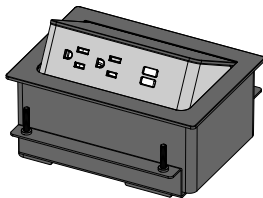

**TILT FLUSH MOUNT**

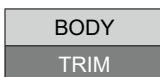

<b>AC2AE</b>	
FEATURES & SPECIFICATIONS	PRICE
<ul style="list-style-type: none"> <li>• Double outlet</li> <li>• Two USB ports</li> <li>• 72" Corded plug</li> <li>• Finish options: Trim: black, silver or white Body: white, grey, black, orange, red, green, blue</li> </ul>	623

<b>AU2AE</b>	
FEATURES & SPECIFICATIONS	PRICE
<ul style="list-style-type: none"> <li>• Double outlet</li> <li>• Two USB ports</li> <li>• 72" Corded plug; optional 10' cord available</li> <li>• Finish options: Trim: black, silver or white Body: white, grey, black, orange, red, green, blue</li> </ul>	573

<b>AF2AE</b>	
FEATURES & SPECIFICATIONS	PRICE
<ul style="list-style-type: none"> <li>• Double outlet</li> <li>• Two USB ports</li> <li>• 72" Corded plug</li> <li>• Finish options: Trim: black, silver or white Body: white, grey, black, orange, red, green, blue</li> </ul>	583

<b>AT2FE</b>	
FEATURES & SPECIFICATIONS	PRICE
<ul style="list-style-type: none"> <li>• Double outlet</li> <li>• Two USB ports</li> <li>• 72" Corded plug</li> <li>• Finish options: Trim: black, silver or white Body: white, grey, black, orange, red, green, blue</li> </ul>	996



<b>ORDER CODE SAMPLE</b>		
ITEM CODE	TRIM	BODY
AF2AE	BLACK	GREY

# Three Power, Dual USB

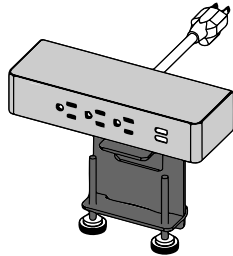

**TRIO CLAMP ON**

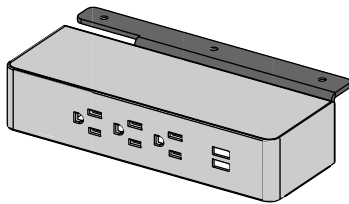

**TRIO UNDERMOUNT**

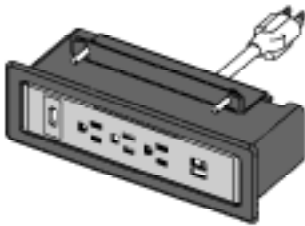

**TRIO FLUSH MOUNT**

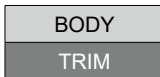

<b>AC3AE</b>	
FEATURES & SPECIFICATIONS	PRICE
<ul style="list-style-type: none"> <li>• Triple outlet</li> <li>• Two USB ports</li> <li>• 72" Corded plug</li> <li>• Finish options: Trim: black, silver or white Body: white, grey, black, orange, red, green, blue</li> </ul>	709

<b>AU3AE</b>	
FEATURES & SPECIFICATIONS	PRICE
<ul style="list-style-type: none"> <li>• Triple outlet</li> <li>• Two USB ports</li> <li>• 72" Corded plug</li> <li>• Finish options: Trim: black, silver or white Body: white, grey, black, orange, red, green, blue</li> </ul>	637

<b>AF3AE</b>	
FEATURES & SPECIFICATIONS	PRICE
<ul style="list-style-type: none"> <li>• Triple outlet</li> <li>• Two USB ports</li> <li>• 72" Corded plug</li> <li>• Finish options: Trim: black, silver or white Body: white, grey, black, orange, red, green, blue</li> </ul>	688



<b>ORDER CODE SAMPLE</b>		
ITEM CODE	TRIM FINISH	BODY FINISH
AF3AE	SILVER	WHITE



# Top Mount Tilting

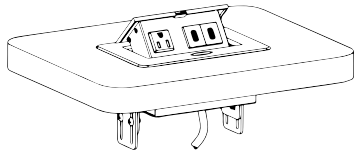

**SINGLE OUTLET, 2 USB**

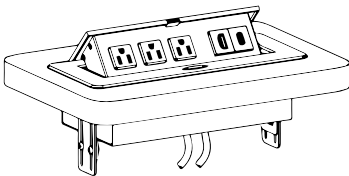

**THREE OUTLET, 1 HDMI & 1 USB**

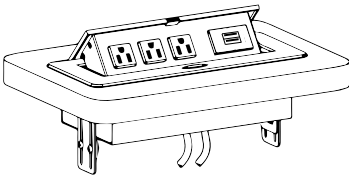

**THREE OUTLET, 2 USB**

## AT1FE

FEATURES & SPECIFICATIONS	PRICE
<ul style="list-style-type: none"> <li>• Single outlet</li> <li>• 2 USB charging ports with separate power adapter</li> <li>• Push button tilting mechanism</li> <li>• 96" black power cable</li> <li>• Finish options: silver only</li> </ul>	520

## AT3FE

FEATURES & SPECIFICATIONS	PRICE
<ul style="list-style-type: none"> <li>• Triple power outlet</li> <li>• One USB charging port with separate power adapter</li> <li>• One HDMI with connecting cable</li> <li>• Push button tilting mechanism</li> <li>• 96" Black power cable</li> <li>• Finish options: silver only</li> </ul>	664

## AT4FE

FEATURES & SPECIFICATIONS	PRICE
<ul style="list-style-type: none"> <li>• Triple power outlet</li> <li>• Two USB charging ports with separate power adapter</li> <li>• Push button tilting mechanism</li> <li>• 96" Black power cable</li> <li>• Finish options: silver only</li> </ul>	625





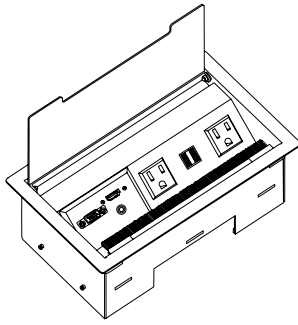







ORDER CODE SAMPLE
ITEM CODE
AT1FE



**INTERACT G2**

AF2RE	FINISH	
	PRICE (BLACK, SILVER, WHITE)	PRICE (ANODIZED ALUMINUM, STAINLESS STEEL)
<b>FEATURES &amp; SPECIFICATIONS</b>		
<ul style="list-style-type: none"> <li>• Two power outlets on top</li> <li>• Additional power outlet on bottom for daisy chaining</li> <li>• Two USB ports</li> <li>• Hinged lid with brush gasket</li> <li>• 72" Black corded plug</li> <li>• Finish options: black, silver or white Brushed anodized aluminum, brushed stainless steel</li> </ul> <p>• Product ships with blank plate unless additional options below are selected when ordering</p>	1,221	1,921



OPTION	FEATURE(S)	PRICE
A	 HDMI	ADD 363
B	 RJ45 CAT6	ADD 225
C	 (2) RJ45 CAT6	ADD 447
D	 (3) RJ45 CAT6	ADD 670
E	 RJ11 CAT3, RJ45 CAT6, USB	ADD 752
F	 RJ11 CAT3, RJ45 CAT6	ADD 337
G	 RJ11 CAT3, (2) RJ45 CAT6	ADD 558
H	 (3) RJ45 CAT5E	ADD 670
J	 VGA, (2) RJ45 CAT6	ADD 713
K	 VGA, RJ45 CAT6, STEREO 3.5	ADD 603



ORDER CODE SAMPLE		
ITEM CODE	FINISH	OPTION
AF2RE	SILVER	D



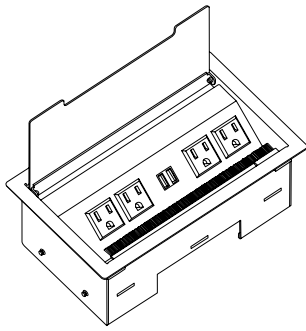







PRODUCT MAP  
ELECTRICAL  
WIRE MANAGEMENT  
UNDER DESK STORAGE  
TASK LIGHTS  
DESK SCREENS  
CONTROLLER  
GROMMETS  
KEYBOARD COMBOS  
CPU HOLDERS  
MONITOR ARMS  
KEYS  
HOOKS  
BRACKETS



**INTERACT IV G2**

AF4RE	FINISH	
	PRICE (BLACK, SILVER, WHITE)	PRICE (ANODIZED ALUMINUM, STAINLESS STEEL)
<b>FEATURES &amp; SPECIFICATIONS</b>		
<ul style="list-style-type: none"> <li>• Four outlets on top</li> <li>• Additional power outlet on bottom for daisy chaining</li> <li>• Two USB ports</li> <li>• Hinged lid with brush gasket</li> <li>• 72" Black corded plug</li> <li>• Finish options: black, silver or white</li> <li>• Brushed anodized aluminum, brushed stainless steel</li> </ul> <p>• Product ships with blank plate unless additional options below are selected when ordering</p>	1,731	2,729



OPTION	FEATURE(S)	PRICE
A	 HDMI	ADD 363
B	 RJ45 CAT6	ADD 225
C	 (2) RJ45 CAT6	ADD 447
D	 (3) RJ45 CAT6	ADD 670
E	 RJ11 CAT3, RJ45 CAT6, USB	ADD 752
F	 RJ11 CAT3, RJ45 CAT6	ADD 337
G	 RJ11 CAT3, (2) RJ45 CAT6	ADD 558
H	 (3) RJ45 CAT5E	ADD 670
J	 VGA, (2) RJ45 CAT6	ADD 713
K	 VGA, RJ45 CAT6, STEREO 3.5	ADD 603





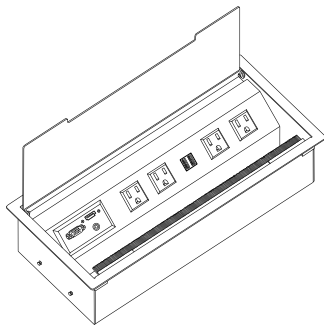







ORDER CODE SAMPLE		
ITEM CODE	FINISH	OPTION
AF4RE	SILVER	B



**INTERFACE G2**

AF4AE		
FEATURES & SPECIFICATIONS	PRICE (BLACK, SILVER, WHITE)	PRICE (ANODIZED ALUMINUM, STAINLESS STEEL)
<ul style="list-style-type: none"> <li>• Four outlets on top</li> <li>• Additional power outlet on bottom for daisy chaining</li> <li>• Two USB ports</li> <li>• Hinged lid with brush gasket</li> <li>• 72" Black corded plug</li> <li>• Finish options: black, silver or white</li> <li>• Brushed anodized aluminum, brushed stainless steel</li> </ul> <p>• Product ships with blank plate unless additional options below are selected when ordering</p>	2,517	3,581



OPTION	FEATURE(S)	PRICE
A	 HDMI	ADD 363
B	 RJ45 CAT6	ADD 225
C	 (2) RJ45 CAT6	ADD 447
D	 (3) RJ45 CAT6	ADD 670
E	 RJ11 CAT3, RJ45 CAT6, USB	ADD 752
F	 RJ11 CAT3, RJ45 CAT6	ADD 337
G	 RJ11 CAT3, (2) RJ45 CAT6	ADD 558
H	 (3) RJ45 CAT5E	ADD 670
J	 VGA, (2) RJ45 CAT6	ADD 713
K	 VGA, RJ45 CAT6, STEREO 3.5	ADD 603



ORDER CODE SAMPLE		
ITEM CODE	FINISH	OPTION
AF4AE	SILVER	K

# Surface Mount Power & Dual USB

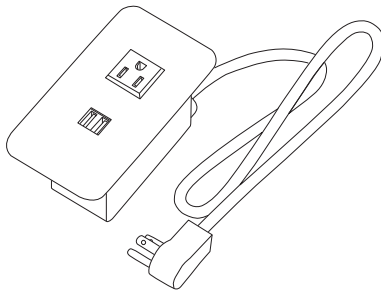

**COVE SURFACE MOUNT SINGLE**

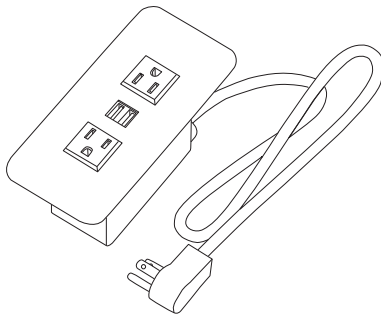

**COVE SURFACE MOUNT DUAL**

<b>AF1BE</b>	<b>FINISH</b>	
<b>FEATURES &amp; SPECIFICATIONS</b>	<b>PRICE (BLACK, SILVER, WHITE)</b>	<b>PRICE (ANODIZED ALUMINUM)</b>
<ul style="list-style-type: none"> <li>• Single outlet</li> <li>• Dual USB charging outlets</li> <li>• 108" Black corded plug</li> <li>• Finish options: black, silver, white or clear brushed aluminum</li> </ul>	867	988

<b>AF2BE</b>	<b>FINISH</b>	
<b>FEATURES &amp; SPECIFICATIONS</b>	<b>PRICE (BLACK, SILVER, WHITE)</b>	<b>PRICE (ANODIZED ALUMINUM)</b>
<ul style="list-style-type: none"> <li>• Dual outlet</li> <li>• Dual USB charging outlets</li> <li>• 108" Black corded plug</li> <li>• Finish options: black, silver, white or clear brushed aluminum</li> </ul>	1,135	1,261



<b>ORDER CODE SAMPLE</b>	
<b>ITEM CODE</b>	<b>FINISH</b>
AF1BE	SILVER

# Pop-Up Wireless Charger with 2 USB

AF0WE

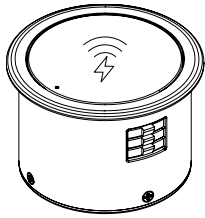

CLOSED - FLUSH

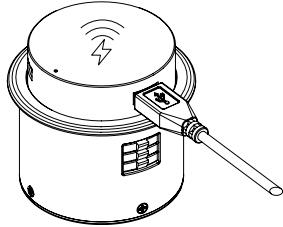

OPEN - USB ACCESS

## WIRELESS CHARGING

### AF0WE

#### FEATURES & SPECIFICATIONS

#### PRICE

- Flush mount
- Pop up design allows simultaneous wireless and access to three USB charging ports
- Three inch hole required for mounting
- Qi compatible
- Will charge through surface up to 1/8"
- Finish options: black only

380



#### ORDER CODE SAMPLE

ITEM CODE

AF0WE

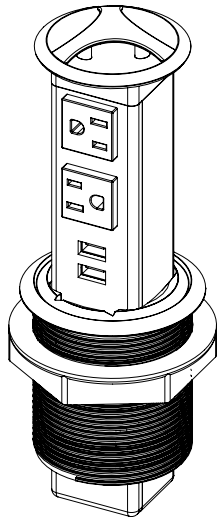

**RETRACTABLE POWER  
STATION**

AP2FE	
FEATURES & SPECIFICATIONS	PRICE
<ul style="list-style-type: none"> <li>• Three inch hole required for mounting</li> <li>• Two AC receptacles, 120v/ 60hz</li> <li>• Two USB 2.1A charging ports</li> <li>• Requires 12" (305mm) space under work surface</li> <li>• Pull up design</li> <li>• 6Ft grounded power cord</li> <li>• Finish options: black only</li> </ul>	399



ORDER CODE SAMPLE
ITEM CODE
AP2FE

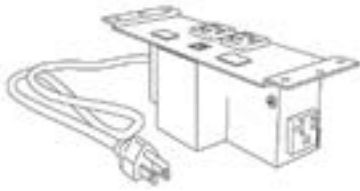

**POWER BASE**

AU2FE	
FEATURES & SPECIFICATIONS	PRICE
<ul style="list-style-type: none"> <li>• Two power outlets</li> <li>• Two USB charging ports</li> <li>• 72" Black corded plug</li> <li>• Base finish options: black or silver</li> <li>• Optional data, video and stereo options as per below</li> <li>• Select cover grommet to complete product</li> </ul>	814



OPTION	FEATURE(S)	PRICE
C	 (2) RJ45 CAT6	ADD 401

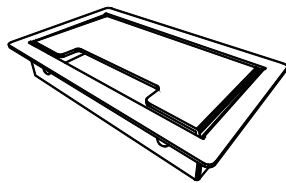

**COVER GROMMET**

COVER		
MODEL	FINISH	PRICE
F-AL	BRUSHED ALUMINUM	ADD 516
F-S	SILVER PAINT	ADD 259
F-B	BLACK PAINT	ADD 259
F-W	GLOSS WHITE PAINT	ADD 259



ORDER CODE SAMPLE		
ITEM CODE - POWER BASE	ITEM CODE - COVER	OPTION
AU2FE	F-SS	K



# Villa Undermount for Training Table Applications

## ADV1E: Villa Single Undermount

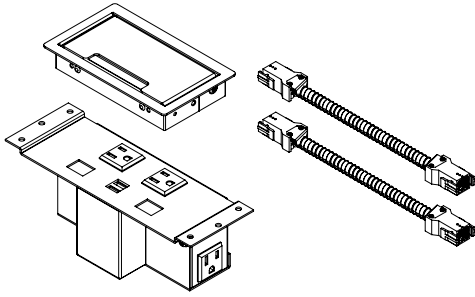

## ADV2E: Villa Double Undermount

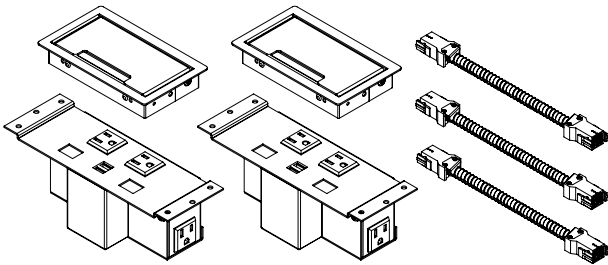

ADV1E	
FEATURES & SPECIFICATIONS	PRICE
<ul style="list-style-type: none"> <li>Includes single power unit, cover, FF cable &amp; FM cable</li> <li>Two power outlets per unit</li> <li>Two USB charging ports per unit</li> <li>Base finish options: black or silver</li> <li>Select cover finish below and add upcharge</li> <li>For infeed cable, add product <b>ADPIE</b></li> </ul>	778

ADV2E	
FEATURES & SPECIFICATIONS	PRICE
<ul style="list-style-type: none"> <li>Includes two power units, two covers, two FF cables &amp; one FM cable</li> <li>Two power outlets per unit</li> <li>Two USB charging ports per unit</li> <li>Base finish options: black or silver</li> <li>Select cover finish below and add upcharge</li> <li>For infeed cable, add product <b>ADPIE</b></li> </ul>	1,366

BASE FINISH		
MODEL	FINISH	PRICE
BLK	BLACK PAINT	INCLUDED
SLV	SILVER PAINT	INCLUDED

COVER FINISH		
MODEL	FINISH	PRICE
F-AL	BRUSHED ALUMINUM	ADD 464
F-S	SILVER PAINT	ADD 233
F-B	BLACK PAINT	ADD 233
F-W	GLOSS WHITE PAINT	ADD 233

OPTION	FEATURE(S)	PRICE
C	 (2) RJ45 CAT6	ADD 422

# Power Bars

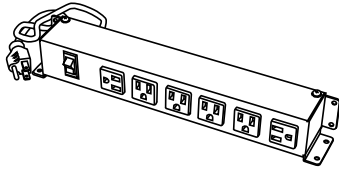

**POWER HUB**

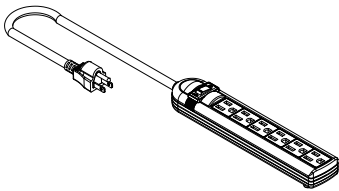

**POWER BAR**

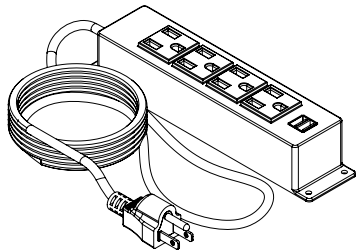

<b>AL6HE</b>	
FEATURES & SPECIFICATIONS	PRICE
<ul style="list-style-type: none"> <li>• 6 Outlet with on/off circuit breaker switch</li> <li>• Heavy duty commercial all metal construction and performance</li> <li>• 108" Corded plug</li> <li>• Under worksurface and/or modesty panel mount provides power to electric table and multiple devices</li> <li>• Finish: black powdercoat</li> </ul>	464

<b>AL6PE</b>	
FEATURES & SPECIFICATIONS	PRICE
<ul style="list-style-type: none"> <li>• 6 Outlet power bar with on/off switch and surge protection</li> <li>• 10' Power cord</li> <li>• 15 Amp</li> <li>• Black plastic housing</li> </ul>	216

<b>AL4BE</b>	
FEATURES & SPECIFICATIONS	PRICE
<ul style="list-style-type: none"> <li>• 4 Outlet power bar with 2 USB charging ports</li> <li>• Easy surface mounting tabs</li> <li>• 15' Power cord</li> <li>• 15 Amp</li> <li>• Black plastic housing</li> </ul>	108



<b>ORDER CODE SAMPLE</b>
ITEM CODE
AL6HE

# Clamp On Power Module

AC2BE

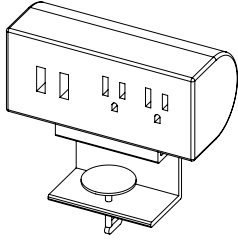

AC2BE	
FEATURES & SPECIFICATIONS	PRICE
<ul style="list-style-type: none"> <li>• Desk mount clamp</li> <li>• Two AC receptacles, 120v/ 60hz</li> <li>• Two USB 3.1A charging ports</li> <li>• 10ft Grounded power cord</li> <li>• Finish options: white only body &amp; frame</li> <li>• 6.25" long x 2.5" high</li> </ul>	285



ORDER CODE SAMPLE
ITEM CODE
AC2BE

# Freestanding Power Module

AFRSE

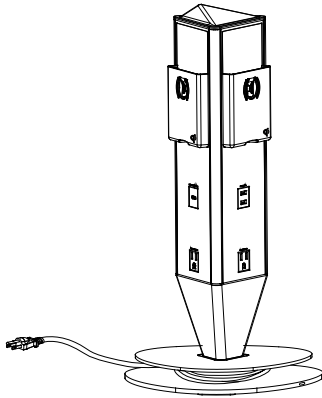

**AFRSE**

FEATURES & SPECIFICATIONS	PRICE
<ul style="list-style-type: none"> <li>• Freestanding power module</li> <li>• Three AC receptacles, 120v/ 60hz 12A</li> <li>• Three Qi wireless rapid chargers</li> <li>• Two USB-A and one USB-C charging ports,</li> <li>• 10ft Grounded power cord</li> <li>• Finish options: silver only</li> <li>• 11.28"w x 11.16"d x 19.82"h</li> </ul>	2,895



<b>ORDER CODE SAMPLE</b>
ITEM CODE
AFRSE

PRODUCT MAP
ELECTRICAL
WIRE MANAGEMENT
UNDER DESK STORAGE
TASK LIGHTS
DESK SCREENS
CONTROLLER
GROMMETS
KEYBOARD COMBOS
CPU HOLDERS
MONITOR-ARMS
KEYS
HOOKS
BRACKETS

# Modesty Panel, Frosted Acrylic

AAMPA

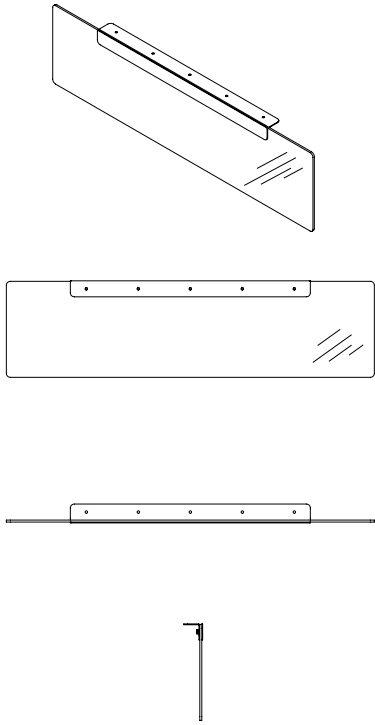

OVERALL SIZE			
WIDTH	HEIGHT	FOR USE WITH TABLE WIDTH	PRICE
28"	12"	36"	406
34"	12"	42"	473
40"	12"	48"	544
46"	12"	54"	611
52"	12"	60"	682
58"	12"	66"	750
64"	12"	72"	821
70"	12"	78"	889
76"	12"	84"	956



ORDER CODE SAMPLE	
ITEM CODE	WIDTH
AAMPA	46

## Features & Specifications

- Includes 3/4" fasteners
- Modesty panel constructed from 1/4" frosted (one side) acrylic panel
- Panel sized to be 8" less than the mounting surface width (eg. 60" width uses 52" modesty)

## No Charge Options

- All standard metal finishes available

PRODUCT MAP  
ELECTRICAL  
WIRE MANAGEMENT  
UNDER DESK STORAGE  
TASK LIGHTS  
DESK SCREENS  
CONTROLLER  
GROMMETS  
KEYBOARD COMBOS  
CPU HOLDERS  
MONITOR ARMS  
KEYS  
HOOKS  
BRACKETS

# Under Worksurface

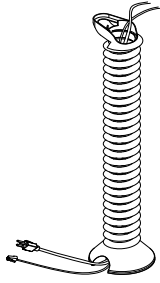

**CABLE MANAGEMENT COIL**



**CABLE MANAGEMENT SPINE**

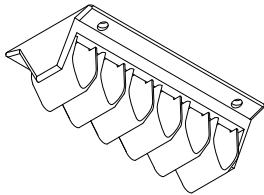

**CABLE CLAMP**

<b>AW12A</b>	
FEATURES & SPECIFICATIONS	PRICE
<ul style="list-style-type: none"> <li>• Spiral coil design 3 3/8" diameter</li> <li>• Mounting top bracket; weighted 6" diameter base</li> <li>• Stretches to 84"</li> <li>• Finish options: black, silver &amp; white</li> </ul>	146

<b>AW13A</b>	
FEATURES & SPECIFICATIONS	PRICE
<ul style="list-style-type: none"> <li>• Black or silver plastic finish</li> <li>• 15 Ring column; 35.5" overall height; 2.25" diameter</li> <li>• Mounting top bracket; weighted base</li> </ul>	224

ORDER CODE	SIZE		
MODEL	LENGTH	RINGS	PRICE
AW14A	3.58"	4	45
AW15A	5.35"	6	59

FEATURES & SPECIFICATIONS
<ul style="list-style-type: none"> <li>• Width is 2.5", height is 1.25"</li> <li>• Under work surface mounting</li> <li>• Electrical and data wires slide into removable rings</li> <li>• Finish options: black only</li> </ul>



<b>ORDER CODE SAMPLE</b>	
ITEM CODE	OPTION
AW13A	BLACK

# Wire Managers

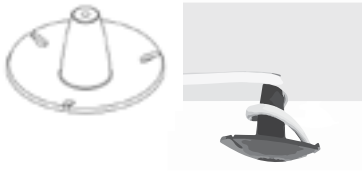

**WRAP AROUND WIRE CLIP**



**CABLE CLIP**



**LARGE WIRE MANAGER**



**SMALL WIRE MANAGER**

<b>AW16A</b>	
FEATURES & SPECIFICATIONS	PRICE
<ul style="list-style-type: none"> <li>• After mounting undersurface, wire wraps around and clips</li> <li>• 4" Diameter by 2" tall</li> <li>• Colour options: grey only</li> </ul>	82

<b>AW17A</b>	
FEATURES & SPECIFICATIONS	PRICE
<ul style="list-style-type: none"> <li>• 1.875" Diameter; accommodates 2" diameter post leg</li> <li>• Snaps on</li> <li>• Finish option: black only</li> </ul>	44

<b>AWMCA</b>	
LENGTH	PRICE
6"	22
12"	43
18"	65
24"	85
36"	99
FEATURES & SPECIFICATIONS	
<ul style="list-style-type: none"> <li>• Black plastic finish</li> <li>• Includes adhesive mounting tape</li> <li>• Approx size 1.5" Wide x 0.875" High</li> </ul>	

<b>AVWMA</b>	
FEATURES & SPECIFICATIONS	PRICE PER FT
<ul style="list-style-type: none"> <li>• Specify length required to a maximum of 6ft (72")</li> <li>• Black plastic finish</li> <li>• Includes adhesive mounting tape</li> <li>• Approx size 0.75" Wide x 0.75" High</li> </ul>	26



<b>ORDER CODE SAMPLE</b>
ITEM CODE
AW17A

# Under Desk Storage

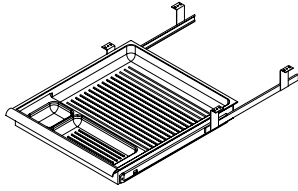

**3 COMPARTMENT PENCIL DRAWER**

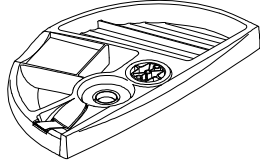

**LARGE CIRCULAR DRAWER**

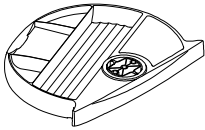

**SMALL CIRCULAR DRAWER**



**6 COMPARTMENT PENCIL DRAWER**

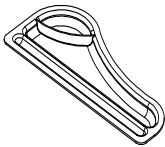

**PENCIL TRAY**

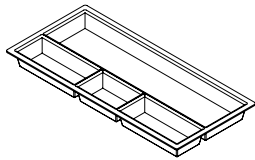

**RECTANGULAR PENCIL TRAY**

<b>AP12A</b>	
FEATURES & SPECIFICATIONS	PRICE
<ul style="list-style-type: none"> <li>• Slide out design</li> <li>• Integral plastic slides mount easily under worksurface</li> <li>• Textured plastic</li> <li>• Finish options: black</li> <li>• Width: 15 1/4"</li> <li>• Installed depth: 15 1/4"</li> <li>• Extended depth: 26"</li> </ul>	147

<b>AP13A</b>	
FEATURES & SPECIFICATIONS	PRICE
<ul style="list-style-type: none"> <li>• Circular swivel design</li> <li>• Under work surface application</li> <li>• 13 19/32" Long, 1 1/4" high, 7 13/32" deep</li> <li>• Plastic</li> <li>• Finish options: matte black, metallic silver</li> </ul>	204

<b>AP14A</b>	
FEATURES & SPECIFICATIONS	PRICE
<ul style="list-style-type: none"> <li>• Circular swivel design</li> <li>• Under work surface application</li> <li>• 9" Long, 1" high, 7 13/32" deep</li> <li>• Plastic</li> <li>• Finish options: matte black, metallic silver</li> </ul>	211

<b>AP15A</b>	
FEATURES & SPECIFICATIONS	PRICE
<ul style="list-style-type: none"> <li>• Slide out design</li> <li>• Integral plastic slides mount easily under worksurface</li> <li>• Textured plastic</li> <li>• Finish options: black</li> <li>• Width: 22 3/8"</li> <li>• Depth: 15 3/8"</li> </ul>	220

<b>AP16A</b>	
FEATURES & SPECIFICATIONS	PRICE
<ul style="list-style-type: none"> <li>• Fits in pedestal width drawer; includes attachment tab &amp; hardware</li> <li>• Textured plastic</li> <li>• Finish options: black</li> <li>• Size: 12" x 6"</li> </ul>	35

<b>AP17A</b>	
FEATURES & SPECIFICATIONS	PRICE
<ul style="list-style-type: none"> <li>• Sits in pedestal width drawer</li> <li>• Textured plastic</li> <li>• Finish options: black</li> <li>• Size: 12" x 6"</li> </ul>	64

▽

<b>ORDER CODE SAMPLE</b>	
ITEM CODE	FINISH
AP14A	<i>BLACK</i>



# Modular LED Task Light

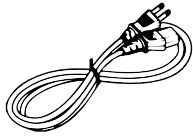

**LED UNDERCABINET LIGHT & POWER CORD**



**12" CABLE FOR DAISY CHAIN**

ORDER CODE		
MODEL	LENGTH	PRICE
ALTLE	12"	230
ALTLE	24"	322
ALTLE	36"	387
ALTLE	48"	529

FEATURES & SPECIFICATIONS
<ul style="list-style-type: none"> <li>• Dimmable with switch</li> <li>• Energy efficient LED</li> <li>• On all lengths height is 1.20" and width is 0.96"</li> <li>• 4,000K temperature with 90 CRI</li> <li>• Includes metal mounting clips</li> <li>• Includes one inline connector to link up to 10 units of any size end to end for continuous light</li> <li>• 72" Power cord included</li> <li>• Finish: white &amp; aluminum only</li> </ul>

ALTCE	
FEATURES & SPECIFICATIONS	PRICE
<ul style="list-style-type: none"> <li>• Use this cable to bridge a gap between lights of any length</li> <li>• For use with undercabinet light above</li> <li>• Length: 12"</li> <li>• Finish: white</li> </ul>	35



ORDER CODE SAMPLE	
ITEM CODE	SIZE
ALTLE	12"



Good To Know

- Lengths are actual size so when choosing to fit in a space, go a size down. For instance, on a 48" wide hutch, order the 36" size task light as the space inside the hutch is less than 48".



ORDER CODE			
MODEL	LENGTH	WATTS	PRICE
ALTFE	24"	14	188
ALTFE	36"	21	256
ALTFE	48"	28	336

FEATURES & SPECIFICATIONS
<ul style="list-style-type: none"> <li>• Energy efficient replaceable T5 fluorescent light</li> <li>• Light head swivels 160°</li> <li>• On all lengths height is 1.1" and width is 3.29"</li> <li>• 4,100K temperature</li> <li>• Includes screws for wood mounting and magnets for metal mounting</li> <li>• 108" Black power cord included</li> <li>• Finish: silver only</li> </ul>



ORDER CODE SAMPLE	
ITEM CODE	SIZE
ALTFE	36"



Good To Know

• Lengths are actual size so when choosing to fit in a space, go a size down. For instance, on a 48" wide hutch, order the 36" size task light as the space inside the hutch is less than 48".

# Freestanding LED Task Light

AFTLE



AFTLE	
FEATURES & SPECIFICATIONS	PRICE
<ul style="list-style-type: none"> <li>• Freestanding LED desktop task light</li> <li>• Includes USB charging</li> <li>• 960 Lumens with dimming</li> <li>• 6.75" w x 15.16" d x 18" h</li> <li>• Includes plug in power adapter</li> <li>• Finish: white</li> </ul>	360



ORDER CODE SAMPLE
ITEM CODE
AFTLE

# Desk Screens

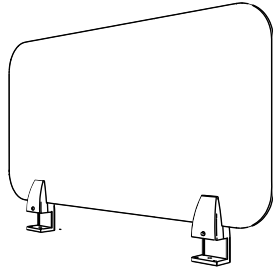

**EDGE OF DESK MOUNT**

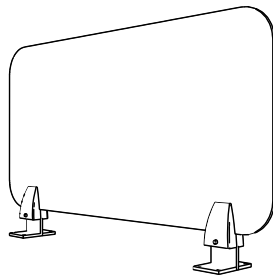

**BETWEEN DESK MOUNT**

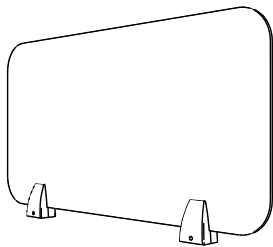
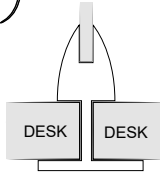

**FLUSH MOUNT**

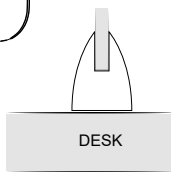

ORDER CODE	SIZE	
MODEL	LENGTH	PRICE
ADS1A	20"	278
ADS1A	24"	336
ADS1A	30"	391
ADS1A	36"	447
ADS1A	48"	559
ADS1A	60"	672

FEATURES & SPECIFICATIONS		
<ul style="list-style-type: none"> <li>• 15" Overall height</li> <li>• Mounts to edge of 1" thick desk</li> <li>• 0.25" Frosted both sides acrylic</li> <li>• Hardware finish options: black, white, silver</li> </ul>		

ORDER CODE	SIZE	
MODEL	LENGTH	PRICE
ADS2A	20"	278
ADS2A	24"	336
ADS2A	30"	391
ADS2A	36"	447
ADS2A	48"	559
ADS2A	60"	672

FEATURES & SPECIFICATIONS		
<ul style="list-style-type: none"> <li>• 15" Overall height</li> <li>• Mounts in between 1" thick surfaces</li> <li>• 0.25" Frosted both sides acrylic</li> <li>• Hardware finish options: black, white, silver</li> </ul>		

ORDER CODE	SIZE	
MODEL	LENGTH	PRICE
ADS3A	20"	262
ADS3A	24"	318
ADS3A	30"	375
ADS3A	36"	430
ADS3A	48"	544
ADS3A	60"	657

FEATURES & SPECIFICATIONS		
<ul style="list-style-type: none"> <li>• 15" Overall height</li> <li>• Flush mount to top of desk</li> <li>• 0.25" Frosted both sides acrylic</li> <li>• Hardware finish options: black, white, silver</li> </ul>		



ORDER CODE SAMPLE		
ITEM CODE	SIZE	FINISH
ADS3A	30"	BLACK

# Height Adjustable Table Accessories

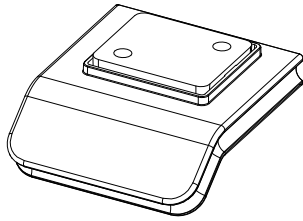

**BASIC CONTROLLER**

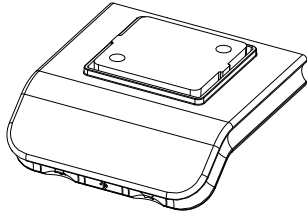

**CONTROLLER WITH BLUETOOTH**

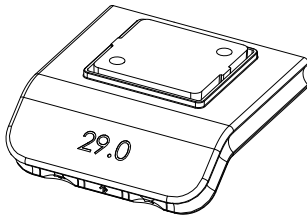

**CONTROLLER WITH BLUETOOTH AND HEIGHT DISPLAY**

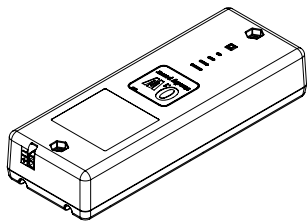

**RECHARGEABLE BATTERY FOR VIVA, SOHO & NOLITA**

**Product Notes**

- These controllers & battery are not available for alta electric tables.
- Contact brc for a link to download the desk control app for iOS and android.



ORDER CODE SAMPLE
ITEM CODE
AE1CE

AE1KE	
FEATURES & SPECIFICATIONS	PRICE
<ul style="list-style-type: none"> <li>• Standard on all Viva electric height adjustable tables</li> <li>• Lift up to raise, push down to lower</li> </ul>	114

AE1BE	
FEATURES & SPECIFICATIONS	PRICE
<ul style="list-style-type: none"> <li>• Lift up to raise, push down to lower</li> <li>• 2 Memory positions</li> <li>• LED light strip reminder</li> <li>• Bluetooth via desk control app</li> <li>• Optional on all Viva electric height adjustable tables</li> <li>• Replaces standard controller DPG1K</li> </ul>	277

AE1CE	
FEATURES & SPECIFICATIONS	PRICE
<ul style="list-style-type: none"> <li>• Lift up to raise, push down to lower</li> <li>• 4 Memory positions</li> <li>• LED light strip reminder</li> <li>• Digital height display in metric or imperial units</li> <li>• Bluetooth via desk control app</li> <li>• Standard on all Soho and NoLita electric height adjustable tables, optional on all Viva tables</li> <li>• Replaces standard controller DPG1K</li> </ul>	349

AEBAE	
FEATURES & SPECIFICATIONS	PRICE
<ul style="list-style-type: none"> <li>• For use with Viva, Soho and NoLita product only; not for use with Alta</li> <li>• High performance 2.2 Ah lithium-ion battery</li> <li>• Typically achieves 50-100 full stroke up and down cycles</li> <li>• Features LED light bar indicating capacity</li> <li>• Audible alarm when charging is required</li> <li>• Can be charged with existing table power cord or included external charging cable</li> <li>• Colour: black only</li> <li>• Includes mounting bracket, connecting cable &amp; external charging cable</li> </ul>	1,402

# Grommets



**3" GROMMET**



**2.5" GROMMET**



**1.75" GROMMET**

<b>AG30A</b>		
FEATURES & SPECIFICATIONS	PRICE GROMMET ONLY	PRICE INSTALLED
<ul style="list-style-type: none"> <li>• Round grommet with removable cover</li> <li>• Fits 80mm hole</li> <li>• Finish: black or white</li> </ul>	34	76

<b>AG25A</b>		
FEATURES & SPECIFICATIONS	PRICE GROMMET ONLY	PRICE INSTALLED
<ul style="list-style-type: none"> <li>• Round grommet with removable cover</li> <li>• Fits 60mm hole</li> <li>• Finish: black only</li> </ul>	33	75

<b>AG17A</b>		
FEATURES & SPECIFICATIONS	PRICE GROMMET ONLY	PRICE INSTALLED
<ul style="list-style-type: none"> <li>• Round grommet with removable cover</li> <li>• Fits 45mm hole</li> <li>• Finish: black only</li> </ul>	32	74



<b>ORDER CODE SAMPLE</b>	
ITEM CODE	OPTION
AG25A	BLACK

# Ventilation Grills

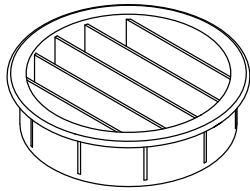

**ROUND**

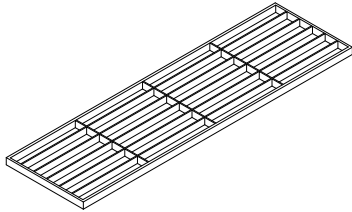

**RECTANGLE**

ORDER CODE		SIZE		
MODEL		DIAMETER	HEIGHT	PRICE
AGVCA		76 mm	20 mm	62
FEATURES & SPECIFICATIONS				
<ul style="list-style-type: none"> <li>• Black or white colour option</li> <li>• Material is plastic</li> </ul>				

ORDER CODE		SIZE			
MODEL		WIDTH	LENGTH	HEIGHT	PRICE
AGVRA		85 mm	300 mm	7 mm	75
FEATURES & SPECIFICATIONS					
<ul style="list-style-type: none"> <li>• Black only</li> <li>• Material is plastic</li> </ul>					



ORDER CODE SAMPLE	
ITEM CODE	FINISH
AGVRA	<i>BLACK</i>

# Keyboard Combos

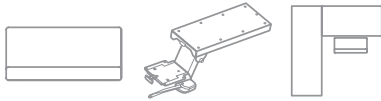

KBTW27 / KBWS-L17

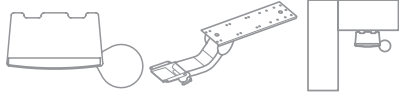

KBT(MS)RM / KBSS

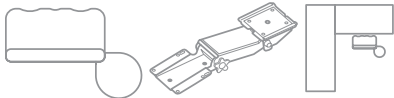

KBT(90)BRM / KBKS-21

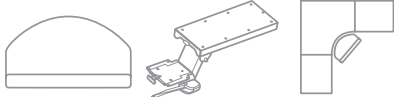

KBC-12 / KBWS-L22

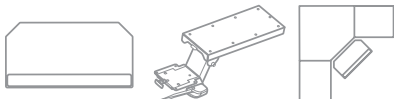

KBT-DC17 / KBWS-L22

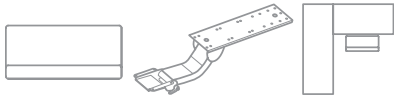

KBTW27 / KBSS

## AK04A

FEATURES & SPECIFICATIONS	PRICE
<ul style="list-style-type: none"> <li>Standard 27" wide rectangular tray.</li> <li>Keyboard and mouse tray with vinyl wrist rest</li> <li>Finish: black only</li> </ul>	995

## AK06A

FEATURES & SPECIFICATIONS	PRICE
<ul style="list-style-type: none"> <li>Composite tray, reversible mouse tray, wrist rest &amp; wire guide</li> <li>KBSS mechanism extends above and below desk</li> <li>Finish: black only</li> </ul>	1,488

## AK09A

FEATURES & SPECIFICATIONS	PRICE
<ul style="list-style-type: none"> <li>Composite tray, reversible mouse tray, wrist rest &amp; wire guide</li> <li>Finish: black only</li> </ul>	639

## AK10A

FEATURES & SPECIFICATIONS	PRICE
<ul style="list-style-type: none"> <li>Keyboard platform with wrist rest</li> <li>Rear surface radiused for 12" corners</li> <li>Finish: black only</li> </ul>	1,064

## AK11A

FEATURES & SPECIFICATIONS	PRICE
<ul style="list-style-type: none"> <li>Keyboard platform with wrist rest</li> <li>Rear surface has notched corners to fit 18" diagonal corner</li> <li>Finish: black only</li> </ul>	732

## AK12A

FEATURES & SPECIFICATIONS	PRICE
<ul style="list-style-type: none"> <li>27" Wide rectangular laminate tray with vinyl wrist rest</li> <li>KBSS mechanism extends above and below desk</li> <li>Finish: black only</li> </ul>	907



ORDER CODE SAMPLE
ITEM CODE
AK10A



# Keyboard Platforms

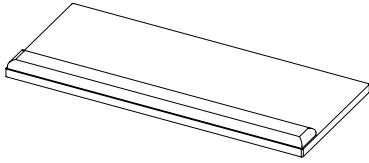

**RECTANGULAR PLATFORM WITH WRIST REST**

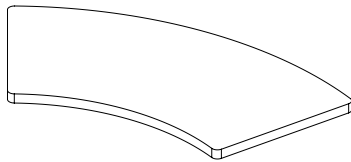

**CURVED PLATFORM WITH WRIST REST**

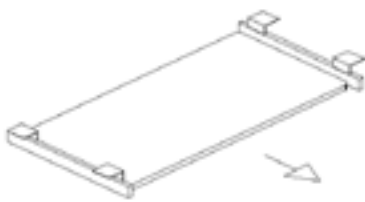

**RETRACTABLE KEYBOARD TRAY**

ORDER CODE	SIZE	
MODEL	WIDTH	PRICE
AKBTA	20"	191
AKBTA	26"	254
AKBTA	27"	254
AKBTA	28"	254
AKBTA	30"	262

FEATURES & SPECIFICATIONS
<ul style="list-style-type: none"> <li>• Upholstered vinyl padded wrist rests available in black only</li> <li>• Laminate keyboard constructed of 0.75" LPL</li> <li>• Includes mounting inserts on underside</li> <li>• Laminate tray available in black only</li> <li>• Depth is 12"</li> </ul>

ORDER CODE	SIZE	LAMINATE			
MODEL	WIDTH	DEPTH	RADIUS	PRICE M1	PRICE H1
AKBCA	28"	16.5"	18"	201	249
AKBCA	30"	16"	24"	201	249

FEATURES & SPECIFICATIONS
<ul style="list-style-type: none"> <li>• Designed to fit all BRC curved corner with same radius</li> <li>• Includes mounting inserts on underside</li> <li>• Laminate tray available in black only</li> <li>• For straight front keyboard, add 'SF' to code</li> <li>• Laminate keyboard constructed of 1" LPL or 1" HPL</li> </ul>

ORDER CODE	SIZE	
MODEL	WIDTH	PRICE
AKBRA	21"	136
AKBRA	28"	136

FEATURES & SPECIFICATIONS
<ul style="list-style-type: none"> <li>• Retractable tray with lock out feature</li> <li>• Laminate keyboard constructed of 0.75" LPL</li> <li>• Fixed height clearance user defined during installation</li> <li>• Can be installed under minimum 20" deep worksurface</li> <li>• Laminate tray available in black only</li> <li>• Depth is 12"</li> </ul>

▽

ORDER CODE SAMPLE	
ITEM CODE	SIZE
AKBRA	28"

# Keyboard Mechanisms

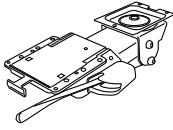

**HEIGHT ADJUSTABLE  
KEYBOARD MECHANISM**

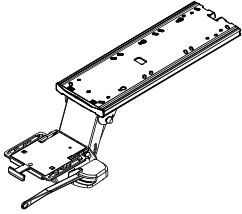

**HEAVY DUTY KEYBOARD  
MECHANISM**

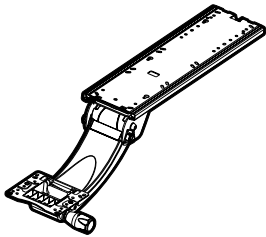

**HEAVY DUTY KEYBOARD  
MECHANISM 2**

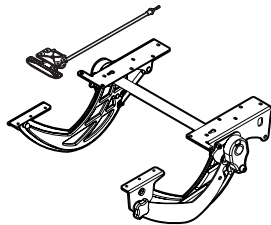

**HEAVY DUTY PADDLE  
ADJUSTABLE DOUBLE  
ARM KEYBOARD TRAY**

ORDER CODE	SIZE	
MODEL	WEIGHT/CUBE	PRICE
AKM1A	8/1.0	473

**FEATURES & SPECIFICATIONS**

- Non retractable & height adjustable for worksurfaces of all depths
- 6" Height adjustment using lever lock actuator
- Easy pull tab activates tray tilt feature
- 15 Degrees positive or 10 degrees negative tray tilt

ORDER CODE	SIZE		
MODEL	WEIGHT/CUBE	Size	PRICE
AKM2A	11/1.5	22	599
AKM2A	11/1.5	17	599

**FEATURES & SPECIFICATIONS**

- Fully retractable low profile support mechanism
- 24" Minimum worksurface depth required
- 6" Height adjustment using lever lock actuator
- Easy pull tab activates tray tilt feature
- 15 Degrees positive or 10 degrees negative tray tilt
- Steel ball bearing slide mechanism

ORDER CODE	SIZE	
MODEL	WEIGHT/CUBE	PRICE
AKM3A	11/1.5	988

**FEATURES & SPECIFICATIONS**

- Fully retractable low profile support mechanism
- 24" Minimum worksurface depth required
- 6" Height adjustment using lever lock actuator
- Easy pull tab activates tray tilt feature
- 15 Degrees positive or 10 degrees negative tray tilt
- Steel ball bearing slide mechanism

ORDER CODE	SIZE		
MODEL	WIDTH	DEPTH	PRICE
AKM4A	23"	20"	736
AKM4A	27"	20"	980

**FEATURES & SPECIFICATIONS**

- Includes 0.75" LPL black tray

**OPTIONAL EXTRA**

- Matching laminate available; specify on order and add \$234

▽

ORDER CODE SAMPLE	
ITEM CODE	SIZE
AKM4A	23"

# Keyboard Corner and Spacers

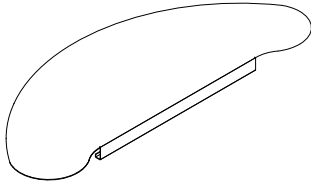

**METAL KEYBOARD CORNER**

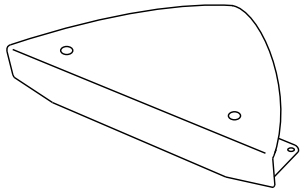

**METAL FIXED KEYBOARD CORNER**



**AKT1A & AKT2A**



**AKT3A**

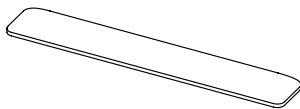

**GEL WRIST REST**

ORDER CODE		SIZE		
MODEL	WIDTH	DEPTH	PRICE	
AULUA	41.5"	16.5"	215	
FEATURES & SPECIFICATIONS				
<ul style="list-style-type: none"> <li>Placed on top in the corner of the worksurface(s)</li> <li>Not intended for use with a keyboard mechanism</li> <li>Includes anti-slip/slide protection on underside</li> <li>Available in all standard BRC metal finishes</li> </ul>				

ORDER CODE		SIZE		
MODEL	WIDTH	PRICE		
AKVCA	12"	223		
FEATURES & SPECIFICATIONS				
<ul style="list-style-type: none"> <li>Updates 90° workstations into corner workstations</li> <li>Accommodates worksurface thickness of 1.00" - 2.25"</li> <li>Black textured powdercoat finish</li> <li>Mounting hardware included</li> </ul>				

ORDER CODE		
MODEL	SPACER HEIGHT	PRICE
AKT1A	1 3/8"	47
AKT2A	2"	66
AKT3A	2"	97
FEATURES & SPECIFICATIONS		
<ul style="list-style-type: none"> <li>Use AKT2A for Alta series tables; AKT1A for all other emotion tables; Includes 6 spacers and attaching hardware</li> <li>Use AKT3A for Mesa series tables; includes 2 brackets</li> <li>All KBW series mechanisms require a 2" spacer kit when installed on Emotion height adjustable products</li> </ul>		

ORDER CODE		SIZE		
MODEL	WIDTH	DEPTH	PRICE	
AKW1A	19"	3"	143	
AKW2A	27"	3"	183	
FEATURES & SPECIFICATIONS				
<ul style="list-style-type: none"> <li>Self tacking underside, black only</li> </ul>				

# CPU Holders

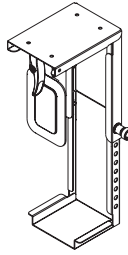

**MINI FIXED MOUNT**

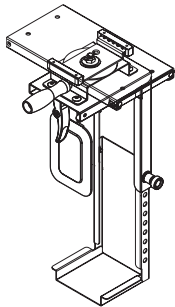

**MINI SLIDE AND SWIVEL**

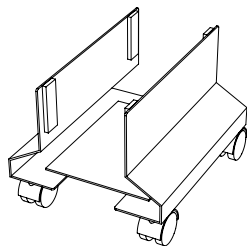

**MOBILE CPU CART**

ORDER CODE		ACCOMMODATES CPU SIZE	
MODEL	HEIGHT RANGE	WIDTH RANGE	PRICE
ACP1A	7.9" - 14"	2" - 4"	221

FEATURES & SPECIFICATIONS			
<ul style="list-style-type: none"> <li>• Finished in black textured powdercoat</li> <li>• Plastic side clamp with bumpers</li> <li>• Side mountable</li> <li>• Fixed unit; does not swivel or retract</li> <li>• Depth: 4.5"</li> <li>• Weight: 8.0 lbs</li> <li>• capacity: 22 lbs</li> </ul>			

ORDER CODE		ACCOMMODATES CPU SIZE	
MODEL	HEIGHT RANGE	WIDTH RANGE	PRICE
ACP2A	3.9" - 14"	2" - 4"	314

FEATURES & SPECIFICATIONS			
<ul style="list-style-type: none"> <li>• Finished in black textured powdercoat</li> <li>• Plastic side clamp with bumpers</li> <li>• Side mountable</li> <li>• Depth: 4.5"</li> <li>• Weight: 8.0 lbs</li> <li>• capacity: 22 lbs</li> </ul>			

ORDER CODE		ACCOMMODATES CPU SIZE	
MODEL	WIDTH RANGE	PRICE	
ACPMMA	5.125" - 10"	224	

FEATURES & SPECIFICATIONS			
<ul style="list-style-type: none"> <li>• All metal construction</li> <li>• Elevates CPU off the floor</li> <li>• Adjustable width</li> <li>• Foam pads on each side cushion CPU</li> <li>• Finished in black only</li> </ul>			

▽

ORDER CODE SAMPLE
ITEM CODE
ACP1A

# CPU Holders

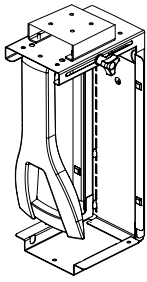

**FULL SIZE FIXED MOUNT**

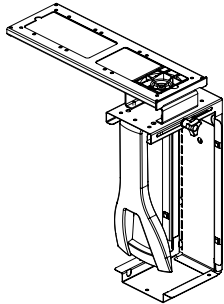

**FULL SIZE SLIDE & SWIVEL**

ORDER CODE		ACCOMMODATES CPU SIZE	
MODEL	HEIGHT RANGE	WIDTH RANGE	PRICE
ACP3A	14.5" - 22.5"	3.5" - 9.3"	476
FEATURES & SPECIFICATIONS			
<ul style="list-style-type: none"> <li>• Finished in black textured powdercoat</li> <li>• Plastic side clamp with bumpers</li> <li>• Side mountable</li> <li>• Fixed unit; does not swivel or retract</li> <li>• Weight: 8.0 lbs</li> <li>• capacity: 50 lbs</li> </ul>			

ORDER CODE		ACCOMMODATES CPU SIZE	
MODEL	HEIGHT RANGE	WIDTH RANGE	PRICE
ACP4A	14.5" - 22.5"	3.5" - 9.3"	712
FEATURES & SPECIFICATIONS			
<ul style="list-style-type: none"> <li>• Finished in black textured powdercoat</li> <li>• Plastic side clamp with bumpers</li> <li>• Ball bearing track slide is 17" deep</li> <li>• 360° Swivel</li> <li>• Side mountable</li> <li>• Weight: 12.4 lbs</li> <li>• Capacity: 50 lbs</li> </ul>			



ORDER CODE SAMPLE
ITEM CODE
ACP4A

# Monitor Arms & TV Mounts

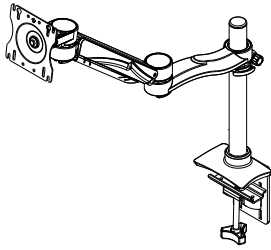

**SINGLE MONITOR ARM**

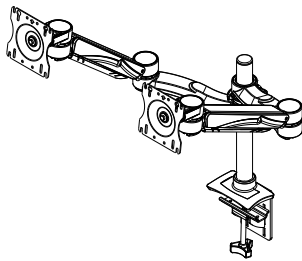

**DUAL MONITOR ARM**

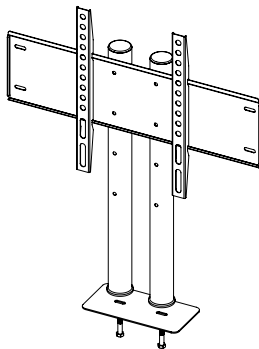

**MEDIA TV MOUNT**

ORDER CODE	SIZE	
MODEL	HEIGHT RANGE	PRICE
AMA1A	12.4"	585
FEATURES & SPECIFICATIONS		
<ul style="list-style-type: none"> <li>• Finished in silver powdercoat</li> <li>• 20lbs load capacity</li> <li>• Desk clamp and grommet mount hardware included</li> <li>• Integrated cable management</li> <li>• Vesa mount accommodates 75mm and 100mm hole patterns</li> <li>• Included allen wrench adjustment</li> </ul>		

ORDER CODE	SIZE	
MODEL	HEIGHT RANGE	PRICE
AMA2A	12.4"	1,016
FEATURES & SPECIFICATIONS		
<ul style="list-style-type: none"> <li>• Finished in silver powdercoat</li> <li>• 20lbs load capacity per screen</li> <li>• Desk clamp and grommet mount hardware included</li> <li>• Integrated cable management</li> <li>• Vesa mount accommodates 75mm and 100mm hole patterns</li> <li>• Maximum 35" screen width</li> <li>• Included allen wrench adjustment</li> </ul>		

ORDER CODE	SIZE	
MODEL	HEIGHT RANGE	PRICE
AMTVD	16-26.5"	908
FEATURES & SPECIFICATIONS		
<ul style="list-style-type: none"> <li>• Finished in black powdercoat</li> <li>• 80lbs load capacity</li> <li>• Permanent table top mount only; requires two holes</li> <li>• Vesa mount accommodates 75mm, 100mm &amp; 200mm hole patterns</li> <li>• Min screen 32" - max 65" diagonal screen width</li> <li>• 4 Adjustable height ranges: 16", 19.5", 23" &amp; 26.5"</li> </ul>		



ORDER CODE SAMPLE	
ITEM CODE	FINISH
AMA2A	SILVER

PRODUCT MAP  
ELECTRICAL  
WIRE MANAGEMENT  
UNDER DESK STORAGE  
TASK LIGHTS  
DESK SCREENS  
CONTROLLER  
GROMMETS  
KEYBOARD COMBOS  
CPU HOLDERS  
MONITOR ARMS  
KEYS  
HOOKS  
BRACKETS

# Hooks

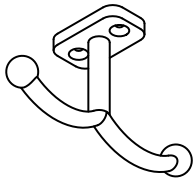

**BAG HOOK**

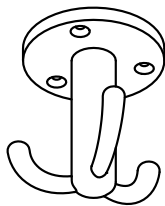

**COAT HOOK**

ORDER CODE		SIZE		
MODEL		WIDTH	HEIGHT	PRICE
AHKBA		0.8"	3.2"	50
FEATURES & SPECIFICATIONS				
<ul style="list-style-type: none"> <li>• Chrome finish only</li> <li>• Material is metal</li> <li>• Accommodates maximum loading of 15 kg</li> <li>• Mounting hardware included</li> </ul>				

ORDER CODE		SIZE		
MODEL		WIDTH	HEIGHT	PRICE
AHKCA		2.1"	2.3"	63
FEATURES & SPECIFICATIONS				
<ul style="list-style-type: none"> <li>• Polished aluminum</li> <li>• Mounting hardware included</li> </ul>				



ORDER CODE SAMPLE	
ITEM CODE	FINISH
AHKBA	CHROME

# Anti-deflection V Bar Supports

AACVA

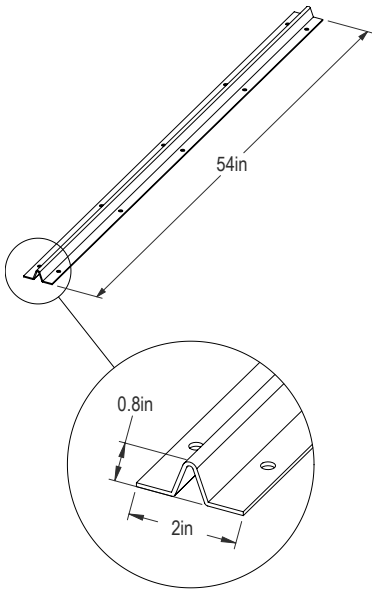

<b>AACVA</b>	
SIZE	PRICE
54"	119
FEATURES & SPECIFICATIONS	
<ul style="list-style-type: none"> <li>• For use with extended unsupported worksurface lengths</li> <li>• Includes 3/4" self tapping wood screws</li> <li>• Black only</li> </ul>	



<b>ORDER CODE SAMPLE</b>
ITEM CODE
AACVA

PRODUCT MAP
ELECTRICAL
WIRE MANAGEMENT
UNDER DESK STORAGE
TASK LIGHTS
DESK SCREENS
CONTROLLER
GROMMETS
KEYBOARD COMBOS
CPU HOLDERS
MONITOR ARMS
KEYS
HOOKS
BRACKETS



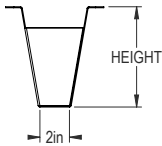
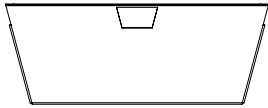
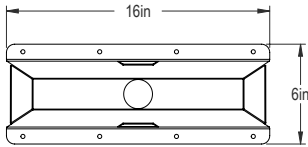
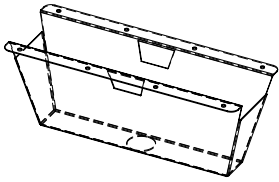

### Features & Specifications

### No Charge Options

ORDER CODE			
SIZE	HEIGHT	LENGTH	PRICE
5.625	5.625"	16"	205
6	6.000"	16"	227

APPLICATION CHART		
BRC STORAGE HEIGHT	SPACER FOR 29" HIGH DESK WITH 1" TOP	SPACER FOR 29" HIGH DESK WITH 0.75" TOP
21.25"	5.625"	6"



ORDER CODE SAMPLE	
ITEM CODE	SIZE
AACSA	5.625

- Mounts using screws to underside and double sided tape (included) to base
- 1.75" Hole at base allows for wire pass through; cabinet must be drilled on site if required
- 0.75" Long Screws provided

- All standard metal finishes available

# Flat Bracket

AAFLA

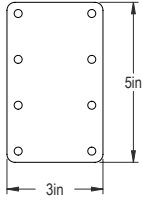
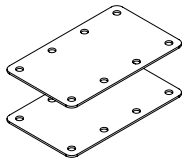

<b>AAFLA</b>	
SIZE	PRICE
3" x 5"	62
FEATURES & SPECIFICATIONS	
<ul style="list-style-type: none"> <li>• Used to support worksurfaces to adjacent furniture</li> <li>• Kit includes two 3" x 5" brackets and 3/4" self tapping wood screws</li> <li>• Black powdercoat finish only</li> </ul>	



<b>ORDER CODE SAMPLE</b>
ITEM CODE
AAFLA

BRACKETS	HOOKS	KEYS	MONITOR ARMS	CPU HOLDERS	KEYBOARD COMBOS	GROMMETS	CONTROLLER	DESK SCREENS	TASK LIGHTS	UNDER DESK STORAGE	WIRE MANAGEMENT	ELECTRICAL	PRODUCT MAP
----------	-------	------	--------------	-------------	-----------------	----------	------------	--------------	-------------	--------------------	-----------------	------------	-------------

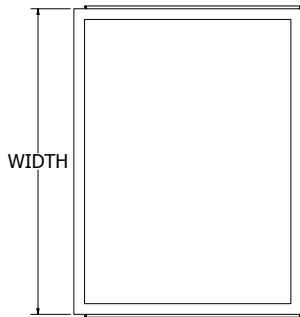
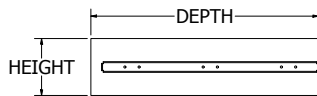
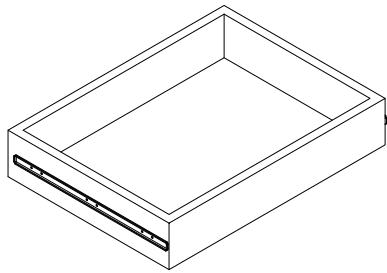

OVERALL SIZE		
WIDTH	HEIGHT	PRICE
13"	3"	201
15.45"	3"	204
21.45"	3"	214
27.45"	3"	225
33.45"	3"	234
39.45"	3"	239
13"	4"	201
15.45"	4"	204
21.45"	4"	214
27.45"	4"	225
33.45"	4"	234
39.45"	4"	239
13"	10"	241
15.45"	10"	247
21.45"	10"	255
27.45"	10"	269
33.45"	10"	279
39.45"	10"	288



ORDER CODE SAMPLE		
ITEM CODE	WIDTH	HEIGHT
AQBBA	15.45	4

**Features & Specifications**

- Intended for drawer box & file replacement only, not for new installations
- Dimensions are exact; measure existing drawer to obtain correct size
- All boxes have a depth of 16" regardless of width or height
- All replacement boxes include mounted slides and top frames to accommodate hanger bars
- Box drawers are black laminate finish
- Does not include drawer front or handle if applicable

**Special Notes**

- Replacement drawer applies to standard product only. Many custom products are created using standard size drawer boxes. Measure existing drawer to confirm replacement size.

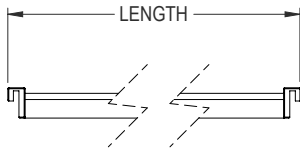
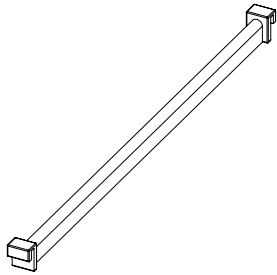

AQFFA	
LENGTH	PRICE
12"	62
14"	62
FEATURES & SPECIFICATIONS	
<ul style="list-style-type: none"> <li>• Use 12" for letter (side to side) and 14" for legal size (front to back) paper</li> <li>• Will fit all standard BRC drawer boxes</li> <li>• Price includes set of two</li> <li>• Black powdercoat &amp; plastic finish only</li> </ul>	



ORDER CODE SAMPLE
ITEM CODE
AQFFA



**BRC MASTER KEY**

AKYMA	
FEATURES & SPECIFICATIONS	PRICE
<ul style="list-style-type: none"> <li>• Can be used to open all standard BRC CL series locks</li> <li>• Key handle is blue</li> </ul>	55



**BRC REMOVAL KEY**

AKYRA	
FEATURES & SPECIFICATIONS	PRICE
<ul style="list-style-type: none"> <li>• Can be used to remove the lock core from any standard BRC CL series lock housing</li> <li>• Key handle is red</li> </ul>	55



**BRC SINGLE LOCK CORE**

AKY1A	
FEATURES & SPECIFICATIONS	PRICE
<ul style="list-style-type: none"> <li>• Single lock set including lockcore &amp; two keys</li> <li>• CL series</li> <li>• If not specified random numbers between 500 and 509 will be assigned</li> <li>• Alternatively specific lock numbers can be ordered from number 551-700</li> <li>• Color options: black or silver</li> </ul>	55



**BRC SINGLE CAM LOCK WITH HOUSING**

AKY2A	
FEATURES & SPECIFICATIONS	PRICE
<ul style="list-style-type: none"> <li>• Single lock set including lockcore, housing with cam &amp; two keys</li> <li>• CL series</li> <li>• If not specified random numbers between 500 and 509 will be assigned</li> <li>• Alternatively specific lock numbers can be ordered from number 551-700</li> <li>• Color options: black or silver</li> </ul>	55

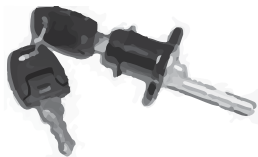

**BRC SINGLE LOCK WITH HOUSING FOR DRAWERS**

AKY3A	
FEATURES & SPECIFICATIONS	PRICE
<ul style="list-style-type: none"> <li>• Single lock set including lockcore, housing with cam &amp; two keys</li> <li>• Housing fits brc standard drawers</li> <li>• CL series</li> <li>• If not specified random numbers between 500 and 509 will be assigned</li> <li>• Alternatively specific lock numbers can be ordered from number 551-700</li> <li>• Color options: black or silver</li> </ul>	55



ORDER CODE SAMPLE	
ITEM CODE	FINISH
AKY2A	SILVER



**HUDSON MASTER KEY**

<b>AKHMA</b>	
FEATURES & SPECIFICATIONS	PRICE
<ul style="list-style-type: none"> <li>• Can be used to open all standard Hudson series locks</li> <li>• Key handle is blue</li> </ul>	55



**HUDSON REMOVAL KEY**

<b>AKHRA</b>	
FEATURES & SPECIFICATIONS	PRICE
<ul style="list-style-type: none"> <li>• Can be used to remove the lock core from any standard Hudson series lock housing</li> <li>• Key handle is red</li> </ul>	55



**HUDSON SINGLE LOCK CORE**

<b>AKH1A</b>	
FEATURES & SPECIFICATIONS	PRICE
<ul style="list-style-type: none"> <li>• Single lock set including lockcore &amp; one key</li> <li>• Hudson series</li> <li>• If not specified random numbers between 226 and 235 will be assigned</li> <li>• Alternatively specific lock numbers can be ordered from number 250-349</li> <li>• Color options: black or silver</li> </ul>	55



**HUDSON SINGLE CAM LOCK WITH HOUSING**

<b>AKH2A</b>	
FEATURES & SPECIFICATIONS	PRICE
<ul style="list-style-type: none"> <li>• Single lock set including lockcore, housing with cam &amp; one key</li> <li>• Hudson series</li> <li>• If not specified random numbers between 226 and 235 will be assigned</li> <li>• Alternatively specific lock numbers can be ordered from number 250-349</li> <li>• Color options: black or silver</li> </ul>	55

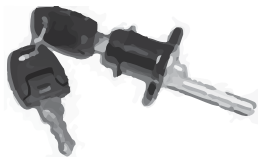

**HUDSON SINGLE LOCK WITH HOUSING FOR DRAWERS**

<b>AKH3A</b>	
FEATURES & SPECIFICATIONS	PRICE
<ul style="list-style-type: none"> <li>• Single lock set including lockcore, housing with cam &amp; one key</li> <li>• Housing fits BRC standard drawers</li> <li>• Hudson series</li> <li>• If not specified random numbers between 226 and 235 will be assigned</li> <li>• Alternatively specific lock numbers can be ordered from number 250-349</li> <li>• Color options: black or silver</li> </ul>	55



<b>ORDER CODE SAMPLE</b>	
ITEM CODE	FINISH
AKH2A	SILVER

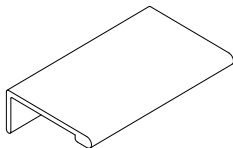
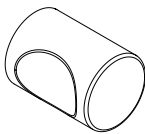
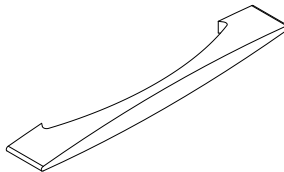
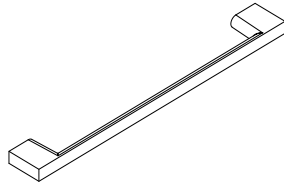
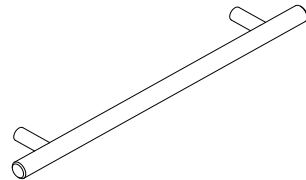
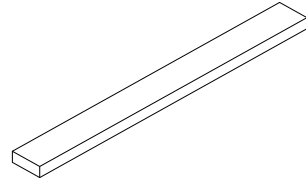
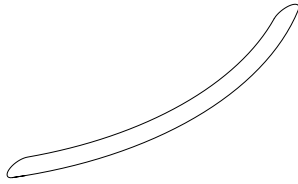

**AQCRA**

FEATURES & SPECIFICATIONS	PRICE
<ul style="list-style-type: none"> <li>• Curve handle</li> <li>• Available in silver and black</li> <li>• Includes mounting hardware</li> </ul>	67

**AQFLA**

FEATURES & SPECIFICATIONS	PRICE
<ul style="list-style-type: none"> <li>• Flat bar handle</li> <li>• Available in silver, black, white and chrome</li> <li>• Includes mounting hardware</li> </ul>	67

**AQHBA**

FEATURES & SPECIFICATIONS	PRICE
<ul style="list-style-type: none"> <li>• H-Bar handle</li> <li>• Available in brushed nickel and black</li> <li>• Includes mounting hardware</li> </ul>	67

**AQNVA**

FEATURES & SPECIFICATIONS	PRICE
<ul style="list-style-type: none"> <li>• Nova handle</li> <li>• Available in brushed nickel</li> <li>• Includes mounting hardware</li> </ul>	67

**AQSTA**

FEATURES & SPECIFICATIONS	PRICE
<ul style="list-style-type: none"> <li>• Stylus handle</li> <li>• Available in matte chrome</li> <li>• Includes mounting hardware</li> </ul>	67

**AQLKA**

FEATURES & SPECIFICATIONS	PRICE
<ul style="list-style-type: none"> <li>• Locker handle</li> <li>• Available in chrome and matte chrome</li> <li>• Includes mounting hardware</li> </ul>	67

**AQEPA**

FEATURES & SPECIFICATIONS	PRICE
<ul style="list-style-type: none"> <li>• Edge pull handle</li> <li>• Available in matte chrome and brushed black</li> <li>• Includes mounting hardware</li> <li>• Note: Handle intended as replacement only, Edge pull cannot be retrofitted to an existing drawer front that did not already have an edge pull handle installed.</li> </ul>	67



ORDER CODE SAMPLE	
ITEM CODE	FINISH
AQCRA	BLACK

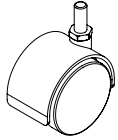

**THREADED STEM CASTER  
NON-LOCKING**

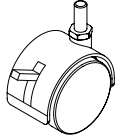

**THREADED STEM CASTER  
LOCKING**

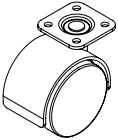

**PLATE MOUNT CASTER  
NON-LOCKING**

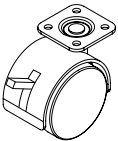

**PLATE MOUNT CASTER  
LOCKING**

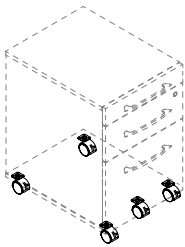

**MOBILE CASTER  
REPLACEMENT KIT**

<b>AQCTA</b>	
FEATURES & SPECIFICATIONS	PRICE
<ul style="list-style-type: none"> <li>• 5/16" Thread</li> <li>• Intended for replacement of standard BRC threaded stem caster</li> <li>• 2.5" Overall height (minus thread)</li> <li>• Black plastic finish</li> </ul>	52 each

<b>AQCSA</b>	
FEATURES & SPECIFICATIONS	PRICE
<ul style="list-style-type: none"> <li>• 5/16" Thread</li> <li>• Intended for replacement of standard BRC locking threaded stem caster</li> <li>• 2.5" Overall height (minus thread)</li> <li>• Black plastic finish</li> </ul>	52 each

<b>AQCPA</b>	
FEATURES & SPECIFICATIONS	PRICE
<ul style="list-style-type: none"> <li>• Intended for replacement of standard BRC plate mount caster</li> <li>• 2.5" Overall height</li> <li>• Black plastic finish and zinc coated top plate</li> </ul>	52 each

<b>AQCLA</b>	
FEATURES & SPECIFICATIONS	PRICE
<ul style="list-style-type: none"> <li>• Intended for replacement of standard BRC locking plate mount caster</li> <li>• 2.5" Overall height</li> <li>• Black plastic finish and zinc coated top plate</li> </ul>	52 each

<b>AQCKA</b>	
FEATURES & SPECIFICATIONS	PRICE
<ul style="list-style-type: none"> <li>• Intended for replacement of standard BRC mobile pedestal casters</li> <li>• Includes 5 locking casters</li> <li>• Black plastic finish</li> </ul>	165 per kit

▽

ORDER CODE SAMPLE
ITEM CODE
AQCKA



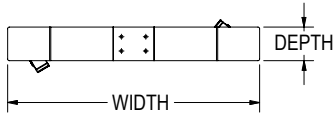
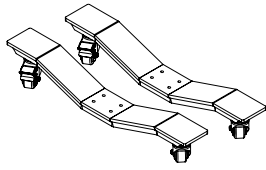

ACTUAL SIZE		
WIDTH	DEPTH	PRICE
23.75"	3.25"	248

Features & Specifications



ORDER CODE SAMPLE
ITEM CODE
AQMFM

No Charge Options

- Kit includes one pair of feet with casters
  - Includes twin wheel casters
  - Used for two leg T configurations only
  - Adjusted height range with BIFMA column: 23" to 48.25"
- 
- Available in standard metal paint finishes

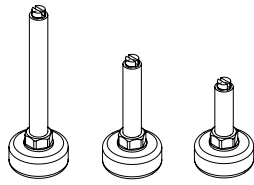

**LEVELER**

AQLLA	
LENGTH	PRICE
1.00"	42 each
1.50"	42 each
2.50"	42 each
FEATURES & SPECIFICATIONS	
<ul style="list-style-type: none"> <li>• 5/16" Thread</li> <li>• Intended for replacement of standard BRC leveler</li> <li>• Size indicates thread length</li> <li>• Black plastic and zinc coated thread stem</li> </ul>	



ORDER CODE SAMPLE	
ITEM CODE	SIZE
AQLLA	1.00

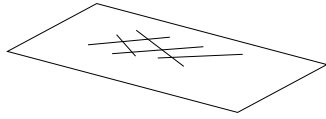

OVERALL SIZE			
WIDTH	DEPTH	DESIGNED FOR LOCKER	PRICE
10.5"	13.5"	_LCKX	165
13.5"	13.5"	_LCKX	165
16"	13.5"	_LCKX	165
18.5"	13.5"	_LCKX	165
10.5"	18.5"	_LCKX	179
13.5"	18.5"	_LCKX	179
18.5"	18.5"	_LCKX	179
10.5"	23.5"	_LCKX	190
13.5"	23.5"	_LCKX	190
18.5"	23.5"	_LCKX	190
11"	16.5"	_LCAX, _LCCX	179
17"	16.5"	_LCAX, _LCCX	179
23.5"	16.5"	_LCTX	205
34.5"	16.5"	_LCTX	220



ORDER CODE SAMPLE		
ITEM CODE	WIDTH	DEPTH
AQBTA	12	18

**Features & Specifications**

- Boot liner can be cut on site to fit if required
- Not available with raised edges
- Sizes listed are 1/4" less overall to account for expansion and contraction
- For custom sizes, indicate actual size required

**No Charge Options**

- All standard metal finishes available

PRODUCT MAP
ELECTRICAL
WIRE MANAGEMENT
UNDER DESK STORAGE
TASK LIGHTS
DESK SCREENS
CONTROLLER
GROMMETS
KEYBOARD COMBOS
CPU HOLDERS
MONITOR ARMS
KEYS
HOOKS
BRACKETS

# Connect Ganging Table Bracket Set

TGNGA

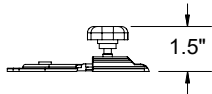
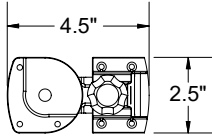
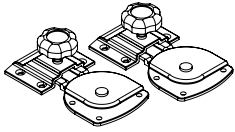

NOMINAL SIZE			
WIDTH	DEPTH	HEIGHT	PRICE
4.5"	2.5"	1.5"	\$45



ORDER CODE SAMPLE
ITEM CODE
AGNGA

## Features & Specifications

- No tools required for operation after installation
- Includes one set as shown
- Finished in black

# Daisy Chain Power Module Accessories

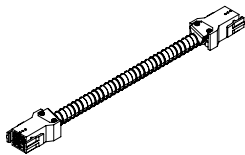
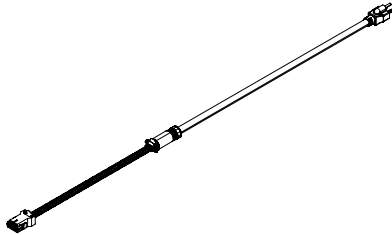
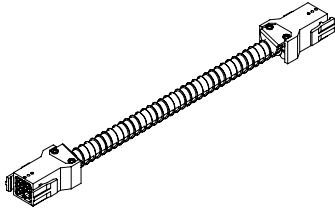

Features & Specifications

ORDER CODE		
MODEL	LENGTH	PRICE
ADFFE	36"	\$146
ADFFE	42"	\$154
ADFFE	48"	\$164
ADFFE	54"	\$173
ADFFE	58"	\$178
ADFFE	64"	\$188
ADFFE	70"	\$197

FEATURES & SPECIFICATIONS
<ul style="list-style-type: none"> <li>Female/Female interconnecting cable</li> </ul>

ADPIE	
FEATURES & SPECIFICATIONS	PRICE
<ul style="list-style-type: none"> <li>Power infeed 3 prong - single circuit</li> <li>Length: 72"</li> </ul>	\$281

ADFNE	
FEATURES & SPECIFICATIONS	PRICE
<ul style="list-style-type: none"> <li>Female/Male interconnecting cable extension</li> <li>Length: 36"</li> </ul>	\$185



ORDER CODE SAMPLE
ITEM CODE
ADFNE

- Metal shielded cables

For sales information contact: [quotes@brc.group](mailto:quotes@brc.group)

24 Armstrong Ave  
Georgetown, ON L7G 4R9  
Phone: 905.873.8509  
Toll Free: 1.877.260.4309  
[info@brc.group](mailto:info@brc.group)

