

This price guide is subject to a

**6% Price Increase\*\***

on listed prices effective

**January 1, 2024**

\*\*excluding Mesa products



2024 SA Ariba Sourcing Project : WS3472349042,  
Ariba Master Agreement CW2240515

# Thank you for choosing BRC

Established in 1979 and incorporated in 1983, BRC Group has grown into a leader in the research, development and manufacturing of high quality ergonomic office furniture. BRC is a Canadian-owned private company with modern manufacturing facilities in Georgetown, Ontario, Canada.

BRC is a forerunner in blending environmental initiatives with the manufacturing of renewable and recyclable products. BRC uses materials and manufacturing processes which virtually eliminate Volatile Organic Chemical (VOC) emissions in the office environment. Raw materials are responsibly sourced, assuring that only the best and most sustainable components are converted to finished goods. BRC is committed to developing and offering the best-value products for the middle and higher end markets.

From OEM solutions to obscure designer requests to simply striving to be better, BRC provides creative and innovative customized solutions to complement any environment and use. Flexible manufacturing offers the ability for BRC to respond to client's special needs rather than having standard catalogue solutions. A wide collection of textiles and laminate finishes allows companies and individuals to express their brand and culture through a unique signature look.

All furniture is designed and manufactured to meet or exceed ANSI-BIFMA standards. Standard construction uses a combination of 3/4" and 1" material and metal to metal commercial grade connections for solid enduring assembly. The newest edge banding technology, in which the edge tape is melted directly to the edge of the board, enables BRC to manufacture products with virtually invisible glue lines.

The BRC Team works hard to earn and keep your business - our success depends on it. If you have any questions or inquires, please contact us at [info@brc.group](mailto:info@brc.group) or toll free at 1-877-260-4309.

We appreciate your business and look forward to hearing from you.

## Warranty, Terms & Conditions

BRC is pleased to offer one of the most competitive warranties in the industry. All furniture products carry a 12 year limited structural warranty. BRC furniture panel and table electrical cabling carry a 3 year limited warranty. All moving user adjustable components carry a 5 year limited structural warranty. All other electrical or electronic elements of BRC furniture carry a 1 year limited warranty.

For full warranty details, terms and conditions, please visit [www.brc.group/warranty](http://www.brc.group/warranty)

## Shipping Rates & Policies

Emotion product should be assumed to ship knocked down. Assembly of the worksurface to the base frame and the frame foot to the base frame assembly will be required on Viva product. Mesa product will be shipped with the worksurface separate and be accompanied by one box for a 2 leg table, and two boxes for a 3 leg table. Assembly instructions are included in the box or available for download on our website at [www.brc.group/installation](http://www.brc.group/installation)

Shipping costs are calculated based on net order value and destination. In many cases, the freight cost may be included in your order. For detailed information, visit our website at [www.brc.group/freight](http://www.brc.group/freight)

PRODUCT MAP
TABLE OF CONTENTS
MESA ELECTRIC
VIVA ELECTRIC
VIVA MANUAL
VIVA INCREMENTAL
VIVA FIXED HEIGHT
SOHO
NOLITA
CONTROLLERS
<a href="http://www.brc.group">www.brc.group</a>

# Emotion Height Adjustable Tables

BRC's Emotion series is a tested and proven height adjustable solution both in the lab and in the field. The product has sustained over 20 years of success and during that time undergone constant refinements and improvements. Rugged construction and reliable electronic components have been tested and certified to ANSI BIFMA & CGSB standards assuring the highest quality.



## A Workstation for Everyone

Stationary desks and workstations present a problem to natural instinct. The human body is designed to benefit from motion which is important for spinal health, improving circulation and reducing muscle fatigue. Height adjustable tables can encourage movement by offering the user multiple sitting and standing positions.

Another benefit is the ability for the user to adjust the desk to the optimal working height for their body both in a sitting and standing position. Even two people who are the same height may have different resting elbow positions and in turn prefer different sitting and standing heights. The benefit is that a workstation can accommodate virtually all users at a cost that is only marginally higher than a fixed height desk providing users an opportunity to break their static posture without leaving the work area.

Height adjustable tables can also provide an inclusive atmosphere for everyone. BRC's line of Mesa and Viva height adjustable electric desks provide a modestly free ADA solution that is wheelchair accessible. In addition, these product lines offer a collision free mechanism that stops table movement when resistance is encountered, preventing injury.

# Guidance & Ordering

**PRODUCT NAME & DESCRIPTION** → Viva 2 Leg Electric Table

**ACTUAL SIZE IN INCHES** →

**WEIGHT IN LBS & CUBIC FT** →

**ALL PRICES IN LIST** →

**PRODUCT CODE** → MWEE

**LAMINATE OPTIONS (ACTUAL THICKNESS in/mm):**  
 M1 - 1" THICK LPL (1.016"/25.8mm)  
 H1 - 1" THICK HPL (1.063"/27.0mm)  
 K1 - 1.25" THICK HPL KNIFE EDGE (1.339"/34mm)

**HYPERLINK TO OTHER ITEMS WITHIN DOCUMENT**

**USE THIS EXAMPLE AS A GUIDE TO ORDER. ENTER OPTION AS REQUIRED.**

**DESCRIPTION OF FEATURES AND INCLUDED ITEMS**

**OPTIONS AND FEATURES AVAILABLE AT NO EXTRA CHARGE**

**OPTIONS OR FEATURES AVAILABLE BUT AT ADDITIONAL CHARGE. ADD CODE WHERE APPLICABLE AND ADDITIONAL PRICE TO TOTAL**

ACTUAL SIZE		LAMINATE		
WIDTH	DEPTH	WEIGHT/CUBE	PRICE M1	PRICE H1
82"	35"	120/72	2,987	3,021
82"	29"	120/72	2,646	2,680
76"	29"	110/72	2,521	2,561
70"	29"	110/72	2,384	2,425
64"	29"	110/60	2,384	2,425
58"	29"	110/60	2,215	2,344
46"	29"	105/48	2,215	2,248
40"	29"	95/48	2,101	2,140
34"	29"	85/36	2,101	2,113
28"	29"	70/30	2,045	2,084
94"	23"	143/30	2,987	3,021
82"	23"	120/30	2,533	2,567
76"	23"	110/30	2,407	2,447
70"	23"	115/72	2,271	2,311
64"	23"	105/60	2,181	2,231
58"	23"	100/48	2,101	2,135
46"	23"	90/48	1,988	2,027
40"	23"	80/36	1,965	1,998
34"	23"	70/30	1,930	1,970
28"	23"	70/30	1,920	1,959

**ORDER CODE SAMPLE**

ITEM CODE	WIDTH	DEPTH	LAMINATE	SCULPTURE	OPTION
MWEE	70	23	H1	SN	LMP

**Features & Specifications**

- Leg provides 1" of leveling
- Laminate codes - M1: 1" LPL, H1: 1" HPL (top only)
- Specify sculpture - SN - none, SR - right, SL - left, or SD - double
- Woodgrain runs horizontally if applicable
- Sculpture is 6" deep (eg: 23" depth is 17" at edge when sculptured)

**No Charge Options**

- Available in all standard laminates
- Available in standard metal paint finishes
- For sizes not listed, specify actual (not nominal) size in product code

**Optional Extra**

- Specify GL (left), GC (center) and/or GR (right) for grommet; add \$56 per grommet
- Specify LMP for laminate modesty panel; add \$126 for tables 48" wide or less and \$205 for tables over 48" wide
- 6" Bow fronts for tables 58" and larger available; add BF to code and \$158

**PRODUCT MAP**  
 TABLE OF CONTENTS | MESA ELECTRIC | VIVA ELECTRIC | VIVA MANUAL | VIVA INCREMENTAL | VIVA FIXED HEIGHT | SOHO | NOLITA | CONTROLLERS

**PRODUCT** →

**SIZE** →

**LAMINATE OPTION** →

**HANDED OPTION** →

**ADDITIONAL OPTIONS** →

**ORDER CODE SAMPLE**

ITEM CODE	WIDTH	DEPTH	LAMINATE	SCULPTURE	OPTION
MWEE	70	23	H1	SN	LMP

**DARKER GREY BOXES CONTAIN CODE DESCRIPTIONS**

**WHITE BOXES INDICATE EXTRA OPTIONS NOT MANDATORY FOR ORDERING. FOR DEFAULT OR NO OPTIONS, LEAVE BLANK**

**LIGHT GREY BOXES INDICATE MANDATORY SELECTION FOR ORDERING**

**ITALICS INDICATE PRODUCT OPTIONS**

**PURCHASE ORDER LINE ITEM FOR ABOVE: MWEE 70 23 H1 SN LMP**

# File Drawers

## Load Considerations

Filing drawers can be one of the most convenient storage items in the office environment. Careful consideration must be paid to how the drawers are loaded, how much load and when to secure the cabinet to an additional support structure. File drawers must always be loaded from the bottom first. This puts the center of gravity lower and reduces the tipping hazard. Depending on application, cabinets should be secured to adjacent cabinets, a wall or another support structure for additional assurance. All drawer cabinets can be susceptible to tipping so careful planning is essential for prevention. Contact your BRC representative for more information.

Look for this warning label placed inside all file drawers manufactured by BRC

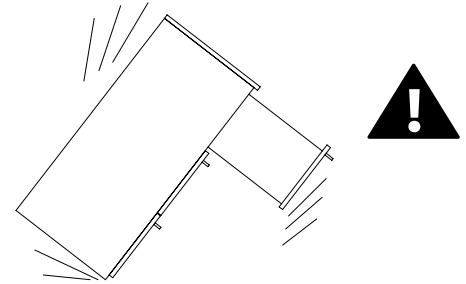
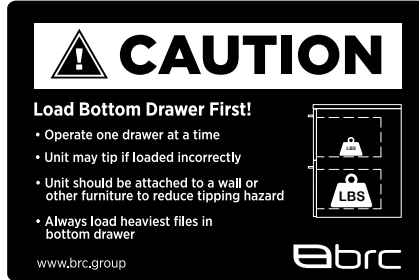

## Capacity & Filing Options

BRC File drawers can accommodate letter and legal hanging file folders. Standard size file drawers in 30", 36" & 42" widths include two side to side hanging bars and two front to back hanging bars (24" wide drawers include only one of each). The side to side hanging bar can be positioned to fit letter and legal files. The front to back hanging bars can be positioned to accommodate two rows front to back of letter and legal depending on drawer width. Pedestal file drawers include one side to side hanging bar that can be positioned to accommodate letter and legal side to side. Pedestal file drawers can accommodate letter only front to back.

STANDARD SIZE FILE DRAWER CAPACITY			
NOMINAL WIDTH	INTERIOR WIDTH	INTERIOR DEPTH	MAXIMUM LOAD (LBS)*
24"	20.4"	15.14"	55
30"	26.4"	15.14"	72
36"	32.4"	15.14"	90

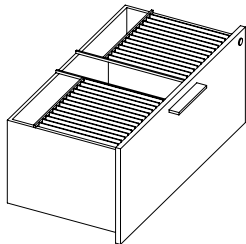

FILE RAILS ACCOMMODATE LEGAL SIDE TO SIDE; FILE BARS CAN BE USED TO ACCOMMODATE LETTER SIDE TO SIDE

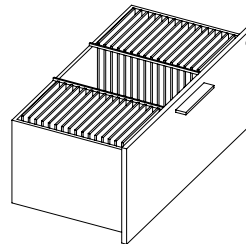

FRONT TO BACK BARS POSITIONED TO ACCOMMODATE LETTER OR LEGAL

PEDESTAL FILE DRAWER CAPACITY			
NOMINAL WIDTH	INTERIOR WIDTH	INTERIOR DEPTH	MAXIMUM LOAD (LBS)*
15.5"	11.9"	15.14"	33

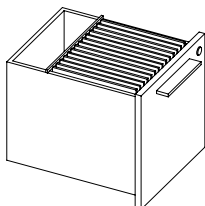

FILE RAILS ACCOMMODATE LEGAL SIDE TO SIDE; FILE BAR CAN BE USED TO ACCOMMODATE LETTER SIDE TO SIDE

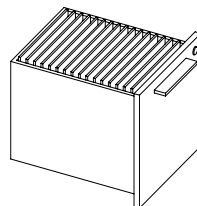

FRONT TO BACK ACCOMMODATES LETTER ONLY

\*Loads are expressed as weight rating for filing, not bottom loading

# Counterweights

## Product Safety

All of BRC's storage products that contain box drawers and file drawers include full extension drawer slides. This presents a unique challenge as the further a drawer is extended, the further away the center of gravity is from the main body of the product. Depending on the load, the storage product may tip over. There are several ways to prevent this from happening and BRC recommends the following solutions be considered depending on the installation. For more information on your specific layout, contact your BRC representative for advice.

## Counterweights

Counterweights are designed to help balance a load in a drawer or several drawers. Depending on the size of the storage product and the load it intends to carry, a counterweight may be the best option. For smaller cabinets, freestanding or mobile, BRC recommends using a counterweight to prevent the product from tipping over. Some of BRC's mobile storage options already include a 5th wheel caster in the front of the drawer which prevents tip over. In this case, the counterweight will not be listed as an option on the individual product page.

Counterweight located  
in back of cabinet (shown)  
or underneath cabinet

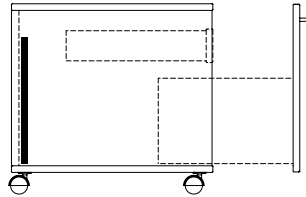

## Ganging

When cabinets are installed in a long run or back to back, ganging them together may be the most cost effective solution. When installing, the drawers can be removed to gain access to the inside back or side gable of the product. After leveling the cabinet layout, by simply using self tapping wood screws with or without pilot holes, items can be ganged together.

Ganging cabinets back to back  
or side to side provides a cost  
effective solution

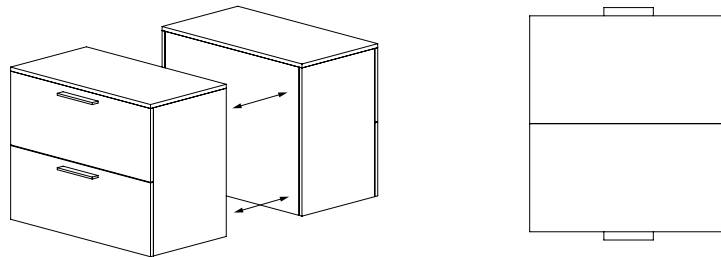

## Wall Mounting

Where applicable, wall mounting can provide a cost effective solution to using a counterweight and provide greater tip over protection. For taller cabinets, bookcases and lockers BRC recommends wall mounting to provide a secure and safe environment. Ensure the wall structure contains wood studs or a wood backing. Attaching to metal studs alone is not recommended. Remove the drawers to gain access to the inside back or side gable of the product. After leveling the cabinet, simply use self tapping wood screws with or without pilot holes and secure the cabinet to the wall. Replace the drawers to complete installation.

Wall mounting all tall storage  
cabinets, bookcases and lockers  
is recommended

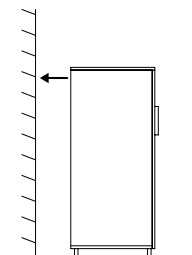

## Wall Mounted Products

Wall mounted items require special consideration before installation. Any product attached to the wall, especially overhead mounted items, must be anchored and secured to the wall to ensure safety and stability. BRC provides the following guidelines & warnings when using wall mounted products:

- This product must be anchored to wall to ensure stability & safety.
- It is the owner and installers responsibility to ensure that the wall type and construction is of sufficient strength to carry the loads of any wall mounted products and their contents.
- Failure of the wall and anchors to support all imposed loads may result in property damage or personal injury.
- BRC can provide size and empty weight of its products only. As wall blocking is considered a building construction process, BRC cannot provide recommendations in this respect and cannot be responsible for damage or injury that may occur as a result of improper installation and/or blocking.

Look for this warning label on all wall mounted BRC products

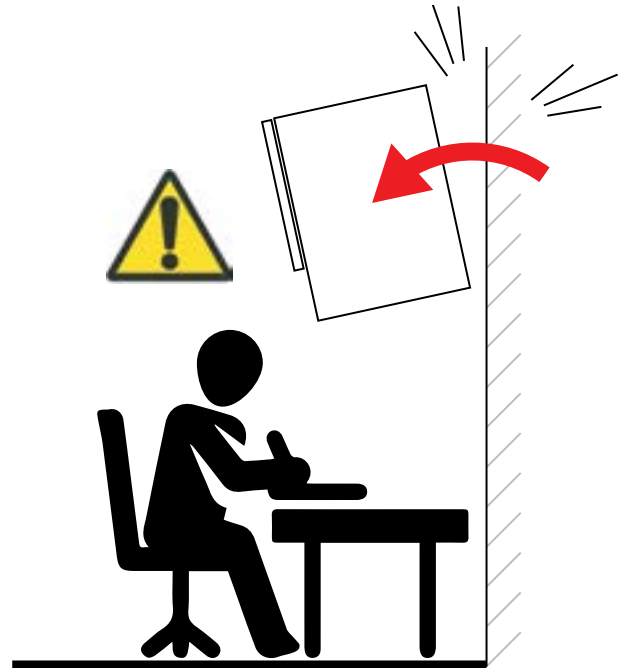

## Mobile Product Instability

Mobile items on casters such as flip top, personal and movable tables of any type and storage items of any type may present an instability hazard if not secured correctly while in use or in storage. Flip top tables or training tables of any type, are inherently more unstable when folded. BRC provides the following guidelines & warnings when using mobile products:

- Lock casters immediately after moving. Do not leave the casters unlocked when in use or in storage.
- Motion may increase the instability of any item with casters. If the wheels hit an obstruction the table's forward momentum often causes overturn, especially if the item is not equipped with wheel extensions. Exercise strong caution while moving these items.
- Use caution when abrupt level changes in the floor are present (such as a doorway or room threshold) as caster failure or tipping may result.
- Do not stand, sit or lean on mobile items for support. They are not intended for this use and personal injury or property damage may result.
- Mobile units that feature height adjustable elements must be lowered to the minimum compressed height when moving to prevent instability. It is also recommended the user remove all computer equipment or other accessories to prevent possible weight imbalance or damage to equipment.
- Failure to follow the guidelines above may result in property damage or personal injury.

Look for this warning label on all mobile BRC products



# Cleaning & Maintenance

## BEST PRACTICES

To keep your furniture products looking their best, BRC recommends the following general care and maintenance:

### Low Pressure (LPL) LAMINATES Cleaning:

Dust laminated surfaces off prior to cleaning. Wet a damp cloth with water, a mild soap or one of our approved cleaning products. Do not use abrasive cleaners as they may scratch or affect the surface appearance. Wipe the surface with the grain (where applicable) using a dry soft cloth.

Approved cleaning products: Glass Plus®, Dawn®, Pledge®, Mr. Clean®, Windex®,

For disinfecting surfaces use products such as: LYSOL®, VIREX®, PURELL®, VIROX®

After use of the above disinfectants ensure that the surfaces are wiped with a damp cloth to remove any product residue.

Take note that any product with Hydrochloric, Sulfuric, or Phosphoric acid may permanently damage the surface. Abrasive elements and excessively acidic or alkaline solutions should be avoided. Prolonged exposure to wet surfaces and/or direct contact with water should be avoided.

### High Pressure (HPL) LAMINATES Cleaning:

Dust laminated surfaces off prior to cleaning. Wet a damp cloth with water, a mild soap or one of our approved cleaning products. Do not use abrasive cleaners as they may scratch or affect the surface appearance. Wipe the surface with the grain (where applicable) using a dry soft cloth.

Approved cleaning products: Glass Plus®, Dawn®, Pledge®, Mr. Clean®, Windex®,

For disinfecting surfaces use products such as: LYSOL®, VIREX®, PURELL®, VIROX®, Fantastik®, multi-surface disinfectant, Clorox® Disinfecting Wipes, Caviwipes™, Cavicide™

After use of the above disinfectants ensure that the surfaces are wiped with a damp cloth to remove any product residue.



Do not saturate or soak furniture with cleaner



Use spray or damp cloth only



Wipe with damp cloth using fresh water after cleaning

Take note that any product with Hydrochloric, Sulfuric, or Phosphoric acid may permanently damage the surface. Abrasive elements and excessively acidic or alkaline solutions should be avoided. Prolonged exposure to wet surfaces and/or direct contact with water should be avoided.

### Acrylic Tiles And Panels:

Dust regularly to keep surfaces free of dust particles. Clean any dirt or stain with a damp cloth. Do not use chemical cleaners or window cleaners as it may alter or permanently affect the surface appearance.

### Tempered & Laminated Glass:

Dust regularly to keep surfaces free of dust particles. Clean any dirt or stain with a damp cloth. Do not use chemical cleaners or window cleaners as it may alter or permanently affect the surface appearance.

### Edge Trim:

To remove minor scuff marks and general dirt from bases and connectors, use warm water and a soft cloth. Do not use harsh abrasive cleaners, as they may cause permanent scratches on the surface.

### Painted Metals:

Clean these products, use a damp cloth, using only a small amount of lukewarm water if necessary. Abrasive elements and excessively acidic or alkaline solutions should be avoided. Prolonged exposure to wet surfaces and/or direct contact with water should be avoided.

### Standard Fabrics:

Standard Care Label W-S. Clean with water based cleaning agents, foam or pure, water free solvents. Vacuuming or light brushing is recommended to prevent dust and soil buildup.

### Bleach Cleanable Fabrics:

Bleach is an effective disinfectant, which means it kills most bacteria, fungi and viruses. When fabrics need to be disinfected or sterilized, use a 1:10 household bleach-to-water solution.

# Standard & Custom Sizing

BRC has built a reputation on custom tailored product based on our standard offering. Many sizes not listed in the Emotion catalog can still be ordered without requesting a custom quote. The next two pages are meant as a guide to enable users to specify and order a custom size right from the price guide. Follow the guidelines below for specifying and ordering sizes that are not listed in this guide.

## Worksurface Size & Pinch Clearance

Standard worksurface sizes listed in the size chart on each page are actual sizes. For instance, a 60" x 24" height adjustable table is manufactured to 60.00" x 24.00". This applies to all products in this guide - Mesa, Viva, SoHo and NoLita.

All Mesa and Viva height adjustable tables are sized to allow for one inch of pinch clearance at the back and on each side of the table. This allows for wire access behind and to the side of the table and provides clearance to avoid pinch points.

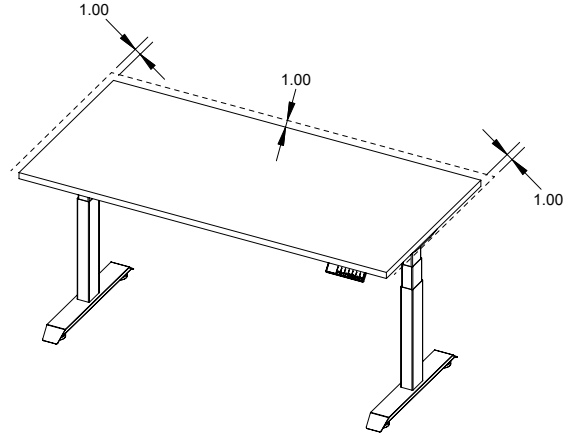
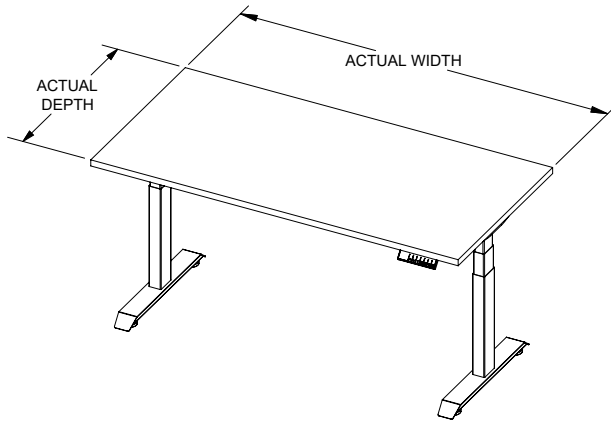

## Custom Size Availability

Most products can be ordered in 0.25" (1/4") increments in either width or depth depending on the sizes listed in the price guide. Custom increments are available between the minimum and maximum sizes listed on the price page. For instance, in the example below, a Mesa table that has a minimum width of 46" and a maximum width of 82" is available in any size in between the minimum and maximum, for example, 54.25" wide or 70.75" wide. When specifying custom, indicate the actual size required, no additions or deductions will be made by BRC. For example, a custom specified width of 65" will be made at 65.00" exactly.

The example details width only but custom size availability applies to depth as well. If applicable, all variables (width, depth & height) can be customized together in one product. For example, the below item could be ordered with a custom width and depth.

Custom sizes outside of the listed minimum and maximum may still be available but require a quote from BRC. Please contact your representative or send your inquiry to [quotes@brc.group](mailto:quotes@brc.group).

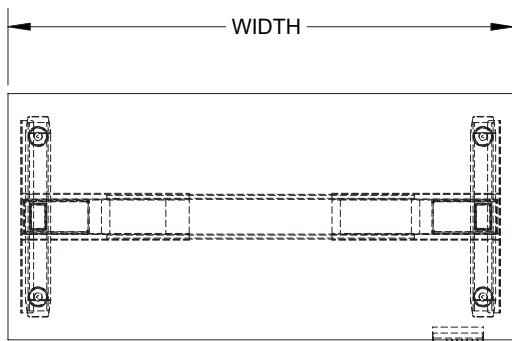

## Next Size Up Pricing

When specifying a custom size, use the pricing applicable to the next size up listed in the price guide. For instance, for a 50.5" width overall, the next largest standard width is 54" at \$400 list, so for a 50.5" depth you would use the \$400 list price.

For more information on next size up pricing, please contact your representative or send your inquiry to [quotes@brc.group](mailto:quotes@brc.group).

PRODUCT MAP
TABLE OF CONTENTS
MESA ELECTRIC
VIVA ELECTRIC
VIVA MANUAL
VIVA INCREMENTAL
VIVA FIXED HEIGHT
SOHO
NOLITA
CONTROLLERS
<a href="http://www.brc.group">www.brc.group</a>

# Custom Sizing

## Order Sample Code

Ordering custom sizes is as easy as placing the size you want in the ordering code and adding an "SP-" prefix to the code. The example below shows how a height adjustable table can be customized and ordered. MWEE Viva product is available in widths from 26" - 82" and depths from 23" - 35". In the order code for a custom size, "MWEE" becomes "SP-MWEE".

### Viva 2 Leg Electric Table

MWEE

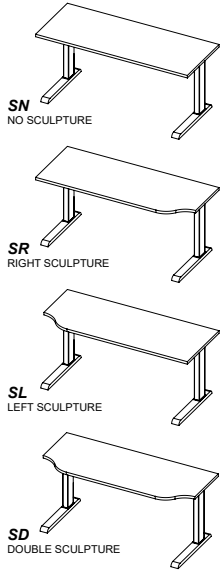

ACTUAL SIZE			LAMINATE	
WIDTH	DEPTH	WEIGHT/CUBE	PRICE M1	PRICE H1
82"	35"	120/72	2,987	3,021
82"	29"	120/72	2,646	2,680
76"	29"	110/72	2,521	2,561
70"	29"	110/72	2,384	2,425
64"	29"	110/60	2,384	2,425
58"	29"	110/60	2,344	2,344
46"	29"	105/48	2,248	2,248
40"	29"	95/48	2,140	2,140
34"	29"	85/36	2,079	2,113
28"	29"	70/30	2,045	2,084
94"	23"	120/72	2,987	3,021
82"	23"	120/72	2,533	2,567
76"	23"	115/72	2,407	2,447
70"	23"	115/72	2,271	2,311
64"	23"	105/60	2,181	2,231
58"	23"	100/48	2,101	2,135
46"	23"	90/48	1,988	2,027
40"	23"	80/36	1,965	1,998
34"	23"	70/30	1,930	1,970
28"	23"	70/30	1,920	1,959

**NOTE:**  
THIS PAGE USES PRODUCT MWEE AS AN EXAMPLE ONLY. OTHER PRODUCTS WILL HAVE DIFFERENT SIZE VARIATIONS DEPENDING ON THE MINIMUM AND MAXIMUM SIZES LISTED. CONSULT EACH PRODUCT PAGE FOR DETAILS ON ITS CUSTOM SIZE AVAILABILITY.

ITEM CODE	WIDTH	DEPTH	LAMINATE	SCULPTURE	OPTION
MWEE	70	23	H1	SN	LMP

**Features & Specifications**

- Leg provides 1" of leveling
- Laminate codes - M1; 1" LPL, H1: 1" HPL (top only)
- Specify sculpture - 'SN' - none, 'SR' - right, 'SL' - left, or 'SD' - double
- Woodgrain runs horizontally if applicable
- Sculpture is 6" deep (eg: 23" depth is 17" at edge when sculptured)

**No Charge Options**

- Available in all standard laminates
- Available in standard metal paint finishes
- For sizes not listed, specify actual (not nominal) size in product code

**Optional Extra**

- Specify GL (left), GC (center) and/or GR (right) for grommet; add \$56 per grommet
- Specify LMP for laminate modesty panel; add \$126 for tables 48" wide or less and \$205 for tables over 48" wide
- 6" Bow fronts for tables 58" and larger available; add BF to code and \$158

PRODUCT MAP  
TABLE OF CONTENTS  
MESA ELECTRIC  
VIVA ELECTRIC  
VIVA MANUAL  
VIVA INCREMENTAL  
VIVA FIXED HEIGHT  
SOHO  
CONTROLLERS  
www.brc.group

DEPTHS AVAILABLE FROM 23" TO 35" ONLY  
WIDTHS AVAILABLE FROM 26" TO 82" ONLY

ORDER CODE SAMPLE FOR STANDARD SIZES

ORDER CODE SAMPLE FOR CUSTOM SIZES

ORDER CODE SAMPLE - CUSTOM SIZE				
ITEM CODE	WIDTH	DEPTH	LAMINATE	SCULPTURE
SP-MWEE	69	26	M1	SN

NEXT SIZE UP SIZE:  
MWEE 70 29 M1  
NEXT SIZE UP PRICE:  
\$ 2,384

ADD "SP-" BEFORE STANDARD CODE  
AVAILABLE IN WIDTHS FROM 26" TO 82"  
AVAILABLE IN DEPTHS FROM 23" TO 35"

PRODUCT MAP  
TABLE OF CONTENTS  
MESA ELECTRIC  
VIVA ELECTRIC  
VIVA MANUAL  
VIVA INCREMENTAL  
VIVA FIXED HEIGHT  
SOHO  
CONTROLLERS  
www.brc.group

# Contents

Welcome	2
Guidance and Ordering	4
File Drawers	5
Counterweights	6
Product Safety	7
Cleaning & Maintenance	8
Standard & Custom Sizing	9
Contents	11
Product Map	12
Products	13

PRODUCT MAP

TABLE OF CONTENTS

MESA ELECTRIC

VIVA ELECTRIC

VIVA MANUAL

VIVA INCREMENTAL

VIVA FIXED HEIGHT

SOHO

NOLITA

CONTROLLERS

www.brc.group



# Product Map

## Mesa Electric T Base SPEC PAGE

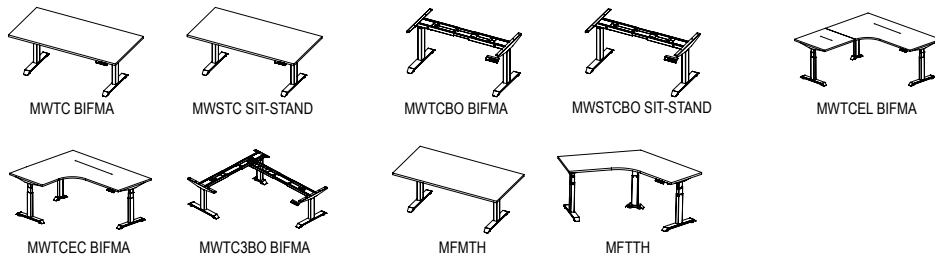

## Mesa Electric C Base



## Mesa Electric Wall Mount

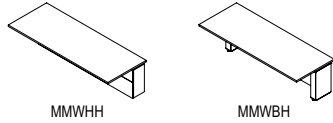

## Mesa Benching

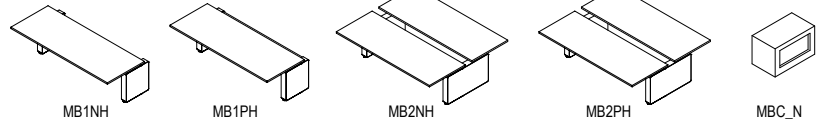

## Viva Electric SPEC PAGE

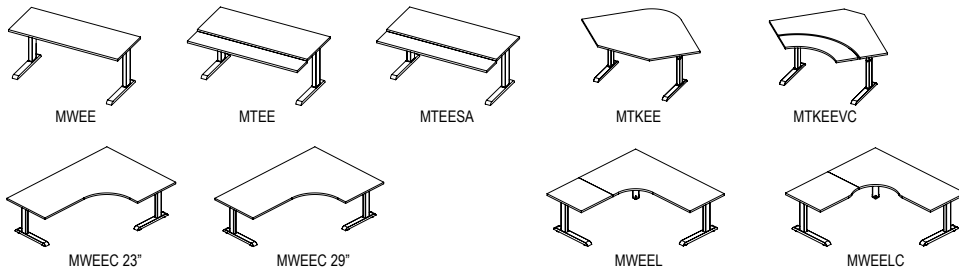

## Viva Manual SPEC PAGE



## Viva Incremental SPEC PAGE

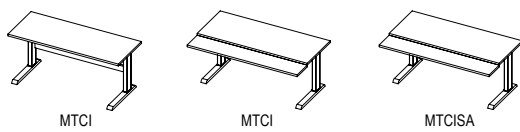

## Viva Fixed Height SPEC PAGE

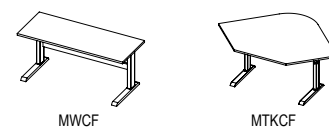

## Service Spine SPEC PAGE

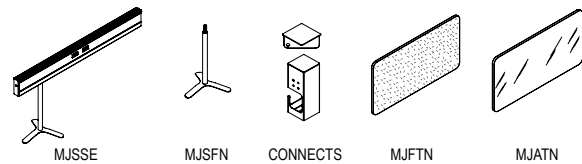

## SoHo SPEC PAGE

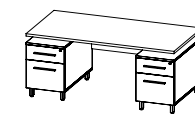

## NoLita SPEC PAGE

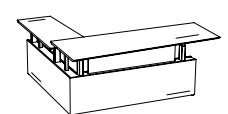

## Controller Options



VIVA

## Rechargeable Battery

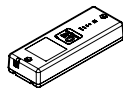

VIVA

## Casters



MESA



VIVA

## HA Table Support SPEC PAGE

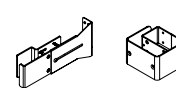

# Mesa

## Economical Electric Height Adjustable Tables

### Standard Features:

- LPL & HPL Worksurfaces available with overall height adjustability from 22.75" to 48.75"
- Programmable anti collision enabled - table will stop if obstruction is encountered
- Full undersurface adjustable width frame prevents lateral movement
- Power ratings: 456W, 3.8 Amp working, 0.5W standby, 108" power cord
- Includes cable management ties for under surface attachment
- Four position memory handset with digital height display
- Modesty free design meets ADA accessibility requirements
- Dual motor with a lift capacity up to 275lbs.
- Optional modesty panel is 10" high

### Basic Dimensions:

#### T-LEG, C-LEG

- Column: 1.9" x 3.0" [48mm x 76mm]
- Foot: 2.95" x 23.65" [75mm x 601mm]
- Foot height: 1.59" [40mm]

#### FRAME

- 1.25" horizontal top frame

### Finishes:

#### BASE

- Powdercoat silver, black & white

#### WORKSURFACE

- 1" LPL & HPL in all standard BRC laminates

### General Product Overview:

Table bases are metal and have a durable scratch resistant, heat cured powder coat paint finish. Metal uprights are 14 gauge tubing and incorporate plastic sleeves throughout for quiet and smooth operation. Low profile foot is constructed of heavy gauge welded steel, with waterfall front and back edges. Feet have oversize levelers for greater stability.

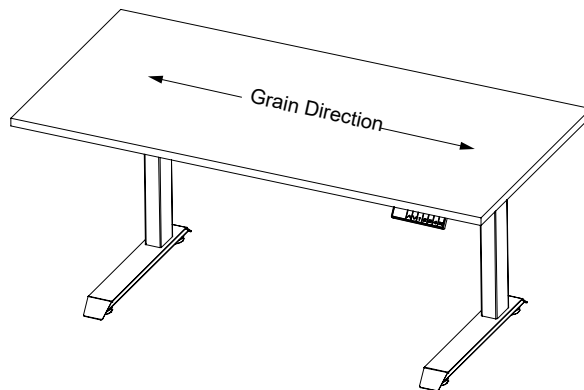
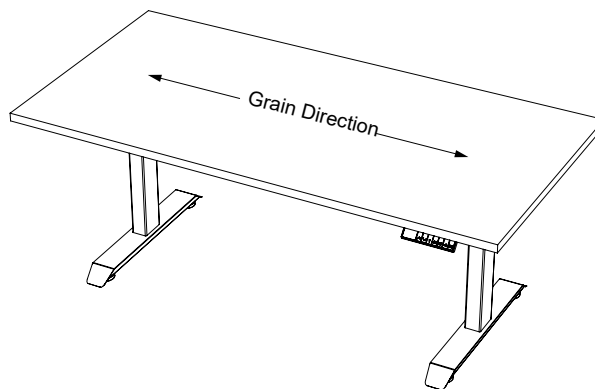

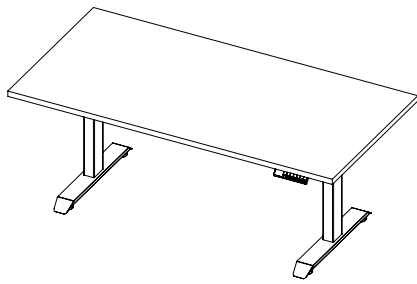

ACTUAL SIZE			LAMINATE	
WIDTH	DEPTH	WEIGHT	PRICE M1	PRICE H1
82"	35"	132	2,143	2,396
82"	29"	123	2,143	2,396
76"	29"	119	2,143	2,396
70"	29"	116	2,143	2,396
58"	29"	109	2,143	2,396
46"	29"	102	1,910	2,036
82"	23"	113	1,910	2,036
76"	23"	110	1,910	2,036
70"	23"	107	1,910	2,036
58"	23"	102	1,910	2,036
46"	23"	97	1,794	1,858
40"	23"	92	1,794	1,858
34"	23"	87	1,794	1,858



ORDER CODE SAMPLE				
ITEM CODE	WIDTH	DEPTH	LAMINATE	OPTION
MWTC	70	23	H1	LMP

Features & Specifications

- Leg provides 1" of leveling
- Laminate codes - M1: 1" LPL, H1: 1" HPL (top only)
- Woodgrain runs width wise if applicable
- The BIFMA height range is 22.75" to 48.75" including the 1" top

No Charge Options

- Available in all standard laminates
- Available in standard metal paint finishes
- For sizes not listed, specify actual (not nominal) size in product code

Optional Extra

- Specify *GL* (left), *GC* (center) and/or *GR* (right) for grommet; add \$76 per grommet
- Specify *LMP* for laminate modesty panel; add \$276

# Mesa Rectangular 2 Leg Electric T Base Table Sit-Stand MWSTC

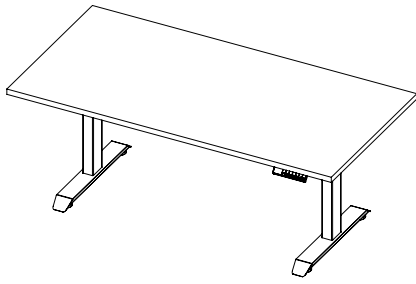

ACTUAL SIZE			LAMINATE	
WIDTH	DEPTH	WEIGHT	PRICE M1	PRICE H1
82"	35"	132	2,143	2,396
82"	29"	123	2,143	2,396
76"	29"	119	2,143	2,396
70"	29"	116	2,143	2,396
58"	29"	109	2,143	2,396
46"	29"	102	1,910	2,036
82"	23"	113	1,910	2,036
76"	23"	110	1,910	2,036
70"	23"	107	1,910	2,036
58"	23"	102	1,910	2,036
46"	23"	97	1,794	1,858
40"	23"	92	1,794	1,858
34"	23"	87	1,794	1,858



ORDER CODE SAMPLE				
ITEM CODE	WIDTH	DEPTH	LAMINATE	OPTION
MWSTC	70	23	H1	LMP

## Features & Specifications

- Leg provides 1" of leveling
- Laminate codes - M1: 1" LPL, H1: 1" HPL (top only)
- Woodgrain runs width wise if applicable
- The Sit to Stand height range is 25" to 51" including the 1" top

## No Charge Options

- Available in all standard laminates
- Available in standard metal paint finishes
- For sizes not listed, specify actual (not nominal) size in product code

## Optional Extra

- Specify *GL* (left), *GC* (center) and/or *GR* (right) for grommet; add \$76 per grommet
- Specify *LMP* for laminate modesty panel; add \$276



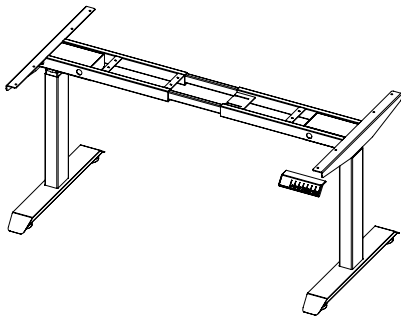

MWTCBO	
FEATURES & SPECIFICATIONS	PRICE
<ul style="list-style-type: none"> <li>• Frame extends to 71" wide</li> <li>• Accommodates worksurface sizes of 40" - 84" wide by 24" - 30" deep</li> </ul>	1,466

Features & Specifications

No Charge Options



ORDER CODE SAMPLE
ITEM CODE
MWTCBO

- Leg provides 1" of leveling
  - All kits include base frame, feet, levellers and Mesa handset controller
  - Assembly instructions included in box
  - Worksurface fastening hardware not included. Screws should be chosen by the installer taking into account the thickness of worksurface used
  - The BIFMA height range is 22.75" to 48.75" including the 1" top
- 
- Available in standard metal paint finishes

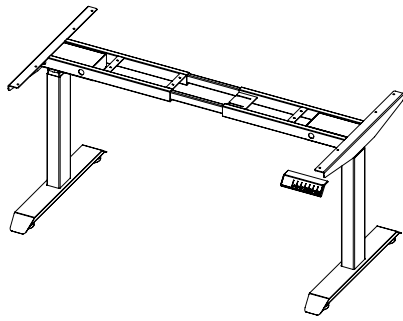

MWSTCBO	
FEATURES & SPECIFICATIONS	PRICE
<ul style="list-style-type: none"> <li>• Frame extends to 71" wide</li> <li>• Accommodates worksurface sizes of 40" - 84" wide by 24" - 30" deep</li> </ul>	1,466

Features & Specifications

No Charge Options



ORDER CODE SAMPLE
ITEM CODE
MWSTCBO

- Leg provides 1" of leveling
  - All kits include base frame, feet, levellers and Mesa handset controller
  - Assembly instructions included in box
  - Worksurface fastening hardware not included. Screws should be chosen by the installer taking into account the thickness of worksurface used
  - The Sit to Stand height range is 25" to 51" including the 1" top
- 
- Available in standard metal paint finishes

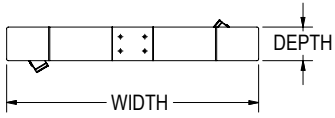
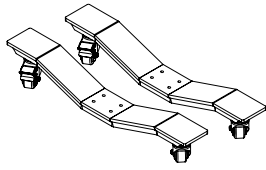

ACTUAL SIZE		
WIDTH	DEPTH	PRICE
23.75"	3.25"	248

Features & Specifications



ORDER CODE SAMPLE
ITEM CODE
AQMFM

- Kit includes one pair of feet with casters
- Includes twin wheel casters
- Used for two leg T configurations only
- Adjusted height range with BIFMA column: 23" to 48.25"

No Charge Options

- Available in standard metal paint finishes

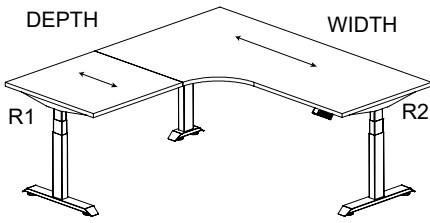

**MR**  
MAIN RIGHT EXTENDED

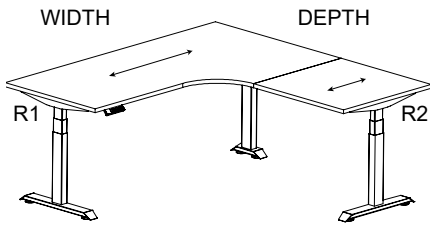

**ML**  
MAIN LEFT EXTENDED

ARROWS INDICATE GRAIN DIRECTION  
(IF APPLICABLE)

ACTUAL SIZE					LAMINATE	
WIDTH	DEPTH	RETURN R1	RETURN R2	RADIUS	PRICE M1	PRICE H1
64"	64"	23" or 29"	23" or 29"	18"	3,661	4,202
64"	70"	23" or 29"	23" or 29"	18"	3,661	4,202
64"	76"	23" or 29"	23" or 29"	18"	3,661	4,202
64"	82"	23" or 29"	23" or 29"	18"	3,661	4,202
70"	64"	23" or 29"	23" or 29"	18"	3,661	4,202
70"	70"	23" or 29"	23" or 29"	18"	3,661	4,202
70"	76"	23" or 29"	23" or 29"	18"	3,661	4,202
70"	82"	23" or 29"	23" or 29"	18"	3,661	4,202
76"	64"	23" or 29"	23" or 29"	18"	3,661	4,202
76"	70"	23" or 29"	23" or 29"	18"	3,661	4,202
76"	76"	23" or 29"	23" or 29"	18"	3,661	4,202
76"	82"	23" or 29"	23" or 29"	18"	3,661	4,202
82"	64"	23" or 29"	23" or 29"	18"	3,661	4,202
82"	70"	23" or 29"	23" or 29"	18"	3,661	4,202
82"	76"	23" or 29"	23" or 29"	18"	3,661	4,202
82"	82"	23" or 29"	23" or 29"	18"	3,661	4,202



ORDER CODE SAMPLE							
ITEM CODE	R1	WIDTH	DEPTH	R2	LAMINATE	HAND	OPTION
MWTCEL	23	82	76	23	M1	ML	LMP

Features & Specifications

No Charge Options

Optional Extra

- Leg provides 1" of leveling
- Laminate codes - M1: 1" LPL, H1: 1" HPL (top only)
- Woodgrain runs width wise if applicable
- Specify hand - "MR" main right extended, "ML" main left extended
- The BIFMA height range is 22.75" to 48.75" including the 1" top
- Available in all standard laminates
- Available in standard metal paint finishes
- For sizes not listed, specify actual (not nominal) size in product code
- For strait front instead of curved front add "SF" to option code
- Specify GL (left), GC (center) and/or GR (right) for grommet; add \$76 per grommet
- Specify LMP for laminate modesty panel; add \$340

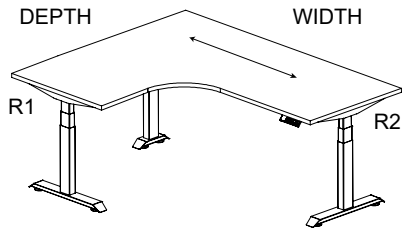

**MR**  
MAIN RIGHT EXTENDED

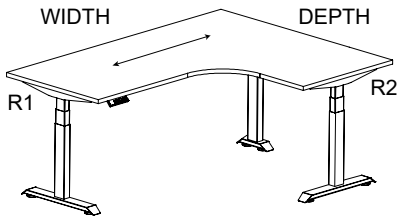

**ML**  
MAIN LEFT EXTENDED

ARROWS INDICATE GRAIN DIRECTION  
(IF APPLICABLE)

ACTUAL SIZE					LAMINATE	
WIDTH	DEPTH	RETURN R1	RETURN R2	RADIUS	PRICE M1	PRICE H1
82"	58"	23" or 29"	23" or 29"	18"	3,535	3,792
76"	58"	23" or 29"	23" or 29"	18"	3,535	3,792
70"	58"	23" or 29"	23" or 29"	18"	3,535	3,792
64"	58"	23" or 29"	23" or 29"	18"	3,535	3,792
82"	52"	23" or 29"	23" or 29"	18"	3,521	3,778
76"	52"	23" or 29"	23" or 29"	18"	3,521	3,778
70"	52"	23" or 29"	23" or 29"	18"	3,521	3,778
64"	52"	23" or 29"	23" or 29"	18"	3,521	3,778
58"	52"	23" or 29"	23" or 29"	18"	3,521	3,778
82"	46"	23" or 29"	23" or 29"	18"	3,508	3,766
76"	46"	23" or 29"	23" or 29"	18"	3,508	3,766
70"	46"	23" or 29"	23" or 29"	18"	3,508	3,766
64"	46"	23" or 29"	23" or 29"	18"	3,508	3,766
58"	46"	23" or 29"	23" or 29"	18"	3,508	3,766
82"	40"	23"	23"	18"	3,427	3,751
76"	40"	23"	23"	18"	3,427	3,751
70"	40"	23"	23"	18"	3,427	3,751
64"	40"	23"	23"	18"	3,427	3,751
58"	40"	23"	23"	18"	3,427	3,751



ORDER CODE SAMPLE							
ITEM CODE	R1	WIDTH	DEPTH	R2	LAMINATE	HAND	OPTION
MWTCEC	29	82	46	29	M1	ML	LMP

Features & Specifications

No Charge Options

Optional Extra

- Leg provides 1" of leveling
- Laminate codes - M1: 1" LPL, H1: 1" HPL (top only)
- Woodgrain runs width wise if applicable
- Specify hand - "MR" main right extended, "ML" main left extended
- The BIFMA height range is 22.75" to 48.75" including the 1" top
- Available in all standard laminates
- Available in standard metal paint finishes
- For sizes not listed, specify actual (not nominal) size in product code
- For strait front instead of curved front add "SF" to option code
- Specify GL (left), GC (center) and/or GR (right) for grommet; add \$76 per grommet
- Specify LMP for laminate modesty panel; add \$340

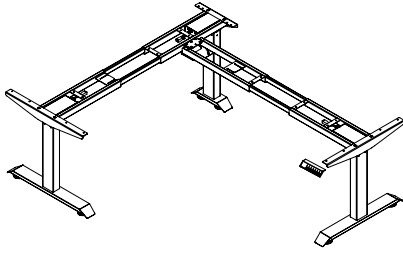

MWTC3BO	
FEATURES & SPECIFICATIONS	PRICE
<ul style="list-style-type: none"> <li>Accommodates worksurface sizes of 48" - 84" wide, returns 48" to 84" wide 24" - 30" deep, and depths 24" - 30"</li> </ul>	2,570

Features & Specifications

No Charge Options



ORDER CODE SAMPLE
ITEM CODE
MWTC3BO

- Leg provides 1" of leveling
  - All kits include base frame, feet, levellers and Mesa handset controller
  - Assembly instructions included in box
  - Worksurface fastening hardware not included. Screws should be chosen by the installer taking into account the thickness of worksurface used
  - The BIFMA height range is 22.75" to 48.75" including the 1" top
- 
- Available in standard metal paint finishes

# Mesa Rectangular 2 Leg Fixed T Base Table

MFMTH

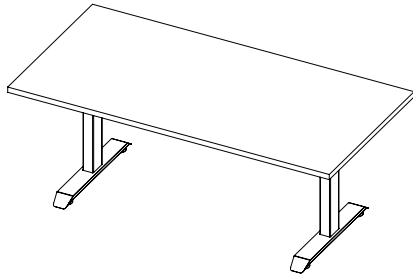

ACTUAL SIZE				LAMINATE	
WIDTH	DEPTH	HEIGHT	WEIGHT	PRICE M1	PRICE H1
84"	36"	29"	132	1,718	1,971
84"	30"	29"	123	1,718	1,971
78"	30"	29"	119	1,718	1,971
72"	30"	29"	116	1,718	1,971
60"	30"	29"	109	1,718	1,971
48"	30"	29"	102	1,485	1,611
84"	24"	29"	113	1,485	1,611
78"	24"	29"	110	1,485	1,611
72"	24"	29"	107	1,485	1,611
60"	24"	29"	102	1,485	1,611
48"	24"	29"	97	1,369	1,433
42"	24"	29"	95	1,369	1,433
36"	24"	29"	92	1,369	1,433
30"	24"	29"	88	1,369	1,433
24"	24"	29"	85	1,369	1,433



ORDER CODE SAMPLE					
ITEM CODE	WIDTH	DEPTH	HEIGHT	LAMINATE	OPTION
MFMTH	72	24	29	H1	LMP

**Features & Specifications**

- Leg provides 1" of leveling
- Laminate codes - M1: 1" LPL, H1: 1" HPL (top only)
- Woodgrain runs width wise if applicable

**No Charge Options**

- Available in all standard laminates
- Available in standard metal paint finishes
- For sizes not listed, specify actual (not nominal) size in product code

**Optional Extra**

- Specify *GL* (left), *GC* (center) and/or *GR* (right) for grommet; add \$76 per grommet
- Specify *LMP* for laminate modesty panel; add \$276

PRODUCT MAP  
TABLE OF CONTENTS  
MESA ELECTRIC  
VIVA ELECTRIC  
VIVA MANUAL  
VIVA INCREMENTAL  
VIVA FIXED HEIGHT  
SOHO  
NOLITA  
CONTROLLERS  
www.brc.group

# Mesa 120 Degree 3 Leg Electric T Base Table

MFTTH

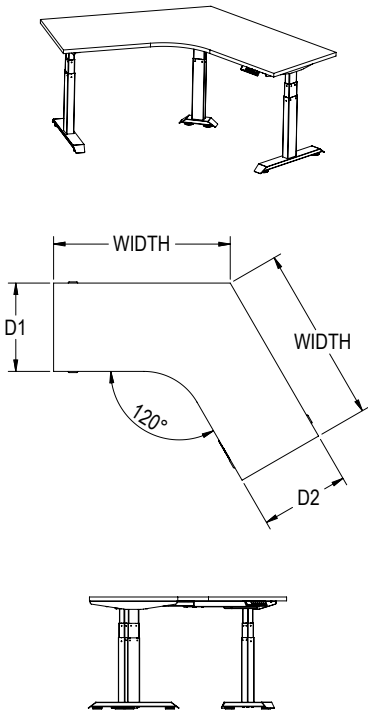

ACTUAL SIZE			LAMINATE	
WIDTH	DEPTH D1	DEPTH D2	PRICE M1	PRICE H1
34"	23" or 29"	23" or 29"	3,836	4,377
40"	23" or 29"	23" or 29"	3,836	4,377
46"	23" or 29"	23" or 29"	3,836	4,377
52"	23" or 29"	23" or 29"	3,836	4,377
58"	23" or 29"	23" or 29"	3,836	4,377

### Features & Specifications

### No Charge Options

### Optional Extra



ORDER CODE SAMPLE					
ITEM CODE	WIDTH	DEPTH D1	DEPTH D2	LAMINATE	OPTION
MFTTH	W72	D24	D30	H1	LMP

- Leg provides 1" of leveling
- Laminate codes - M1: 1" LPL, H1: 1" HPL (top only)
- Worksurface may have a seam

- Available in all standard laminates
- Available in standard metal paint finishes
- For sizes not listed, specify actual (not nominal) size in product code

- Specify *GL* (left), *GC* (center) and/or *GR* (right) for grommet; add \$76 per grommet
- Specify *LMP* for laminate modesty panel; add \$435

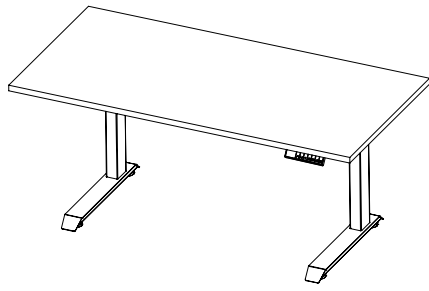

ACTUAL SIZE			LAMINATE	
WIDTH	DEPTH	WEIGHT	PRICE M1	PRICE H1
82"	35"	132	2,411	2,665
82"	29"	123	2,411	2,665
76"	29"	119	2,411	2,665
70"	29"	116	2,411	2,665
58"	29"	109	2,411	2,665
46"	29"	102	2,178	2,305
82"	23"	113	2,178	2,305
76"	23"	110	2,178	2,305
70"	23"	107	2,178	2,305
58"	23"	102	2,178	2,305
46"	23"	97	2,062	2,126
40"	23"	92	2,062	2,126
34"	23"	87	2,062	2,126



ORDER CODE SAMPLE				
ITEM CODE	WIDTH	DEPTH	LAMINATE	OPTION
MWCL	70	23	H1	LMP

Features & Specifications

- Leg provides 1" of leveling
- Laminate codes - M1: 1" LPL, H1: 1" HPL (top only)
- Woodgrain runs width wise if applicable
- The BIFMA height range is 22.75" to 48.75" including the 1" top

No Charge Options

- Available in all standard laminates
- Available in standard metal paint finishes
- For sizes not listed, specify actual (not nominal) size in product code

Optional Extra

- Specify *GL* (left), *GC* (center) and/or *GR* (right) for grommet; add \$76 per grommet
- Specify *LMP* for laminate modesty panel; add \$276

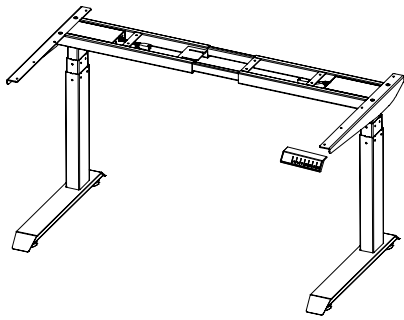

MWCLBO	
FEATURES & SPECIFICATIONS	PRICE
<ul style="list-style-type: none"> <li>• Frame extends to 71" wide</li> <li>• Accommodates worksurface sizes of 40" - 84" wide by 24" - 30" deep</li> </ul>	1,737

Features & Specifications

No Charge Options



ORDER CODE SAMPLE
ITEM CODE
MWCLBO

- Leg provides 1" of leveling
  - All kits include base frame, feet, levellers and Mesa handset controller
  - Assembly instructions included in box
  - Worksurface fastening hardware not included. Screws should be chosen by the installer taking into account the thickness of worksurface used
  - The BIFMA height range is 22.75" to 48.75" including the 1" top
- 
- Available in standard metal paint finishes

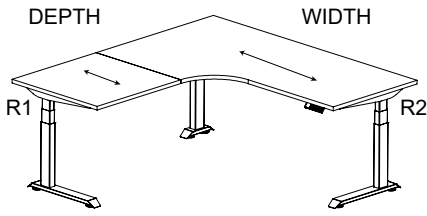

**MR**  
MAIN RIGHT EXTENDED

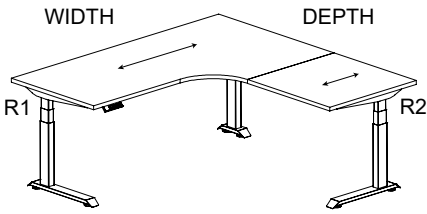

**ML**  
MAIN LEFT EXTENDED

ARROWS INDICATE GRAIN DIRECTION  
(IF APPLICABLE)

ACTUAL SIZE					LAMINATE	
WIDTH	DEPTH	RETURN R1	RETURN R2	RADIUS	PRICE M1	PRICE H1
64"	64"	23" or 29"	23" or 29"	18"	3,928	4,470
64"	70"	23" or 29"	23" or 29"	18"	3,928	4,470
64"	76"	23" or 29"	23" or 29"	18"	3,928	4,470
64"	82"	23" or 29"	23" or 29"	18"	3,928	4,470
70"	64"	23" or 29"	23" or 29"	18"	3,928	4,470
70"	70"	23" or 29"	23" or 29"	18"	3,928	4,470
70"	76"	23" or 29"	23" or 29"	18"	3,928	4,470
70"	82"	23" or 29"	23" or 29"	18"	3,928	4,470
76"	64"	23" or 29"	23" or 29"	18"	3,928	4,470
76"	70"	23" or 29"	23" or 29"	18"	3,928	4,470
76"	76"	23" or 29"	23" or 29"	18"	3,928	4,470
76"	82"	23" or 29"	23" or 29"	18"	3,928	4,470
82"	64"	23" or 29"	23" or 29"	18"	3,928	4,470
82"	70"	23" or 29"	23" or 29"	18"	3,928	4,470
82"	76"	23" or 29"	23" or 29"	18"	3,928	4,470
82"	82"	23" or 29"	23" or 29"	18"	3,928	4,470



ORDER CODE SAMPLE							
ITEM CODE	R1	WIDTH	DEPTH	R2	LAMINATE	HAND	OPTION
MWTCEL	23	82	76	23	M1	ML	LMP

Features & Specifications

No Charge Options

Optional Extra

- Leg provides 1" of leveling
- Laminate codes - M1: 1" LPL, H1: 1" HPL (top only)
- Woodgrain runs width wise if applicable
- Specify hand - "MR" main right extended, "ML" main left extended
- The BIFMA height range is 22.75" to 48.75" including the 1" top
- Available in all standard laminates
- Available in standard metal paint finishes
- For sizes not listed, specify actual (not nominal) size in product code
- For strait front instead of curved front add "SF" to option code
- Specify GL (left), GC (center) and/or GR (right) for grommet; add \$76 per grommet
- Specify LMP for laminate modesty panel; add \$340

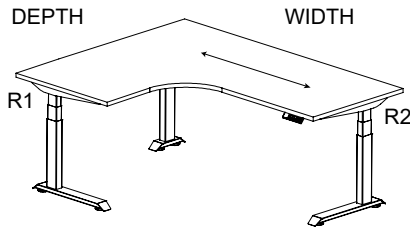

**MR**  
MAIN RIGHT EXTENDED

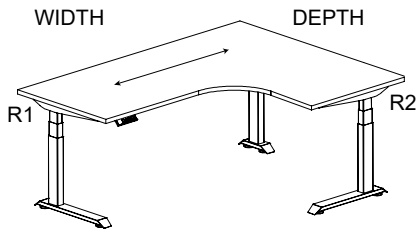

**ML**  
MAIN LEFT EXTENDED

ARROWS INDICATE GRAIN DIRECTION  
(IF APPLICABLE)

ACTUAL SIZE					LAMINATE	
WIDTH	DEPTH	RETURN R1	RETURN R2	RADIUS	PRICE M1	PRICE H1
82"	58"	23" or 29"	23" or 29"	18"	3,802	4,060
76"	58"	23" or 29"	23" or 29"	18"	3,802	4,060
70"	58"	23" or 29"	23" or 29"	18"	3,802	4,060
64"	58"	23" or 29"	23" or 29"	18"	3,802	4,060
82"	52"	23" or 29"	23" or 29"	18"	3,790	4,046
76"	52"	23" or 29"	23" or 29"	18"	3,790	4,046
70"	52"	23" or 29"	23" or 29"	18"	3,790	4,046
64"	52"	23" or 29"	23" or 29"	18"	3,790	4,046
58"	52"	23" or 29"	23" or 29"	18"	3,790	4,046
82"	46"	23" or 29"	23" or 29"	18"	3,775	4,033
76"	46"	23" or 29"	23" or 29"	18"	3,775	4,033
70"	46"	23" or 29"	23" or 29"	18"	3,775	4,033
64"	46"	23" or 29"	23" or 29"	18"	3,775	4,033
58"	46"	23" or 29"	23" or 29"	18"	3,775	4,033
82"	40"	23"	23"	18"	3,763	4,020
76"	40"	23"	23"	18"	3,763	4,020
70"	40"	23"	23"	18"	3,763	4,020
64"	40"	23"	23"	18"	3,763	4,020
58"	40"	23"	23"	18"	3,763	4,020



ORDER CODE SAMPLE							
ITEM CODE	R1	WIDTH	DEPTH	R2	LAMINATE	HAND	OPTION
MWCLEC	29	82	46	29	M1	ML	LMP

Features & Specifications

No Charge Options

Optional Extra

- Leg provides 1" of leveling
- Laminate codes - M1: 1" LPL, H1: 1" HPL (top only)
- Woodgrain runs width wise if applicable
- Specify hand - "MR" main right extended, "ML" main left extended
- The BIFMA height range is 22.75" to 48.75" including the 1" top
- Available in all standard laminates
- Available in standard metal paint finishes
- For sizes not listed, specify actual (not nominal) size in product code
- For strait front instead of curved front add "SF" to option code
- Specify GL (left), GC (center) and/or GR (right) for grommet; add \$76 per grommet
- Specify LMP for laminate modesty panel; add \$340

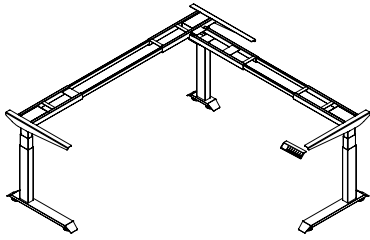

MWCL3BO	
FEATURES & SPECIFICATIONS	PRICE
<ul style="list-style-type: none"> <li>Accommodates worksurface sizes of 48" - 84" wide, returns 48" to 84" wide 24" - 30" deep, and depths 24" - 30"</li> </ul>	2,839

Features & Specifications

No Charge Options



ORDER CODE SAMPLE
ITEM CODE
MWCL3BO

- Leg provides 1" of leveling
  - All kits include base frame, feet, levellers and Mesa handset controller
  - Assembly instructions included in box
  - Worksurface fastening hardware not included. Screws should be chosen by the installer taking into account the thickness of worksurface used
  - The BIFMA height range is 22.75" to 48.75" including the 1" top
- 
- Available in standard metal paint finishes

# Mesa Rectangular 2 Leg Fixed C Base Table

MFMCH

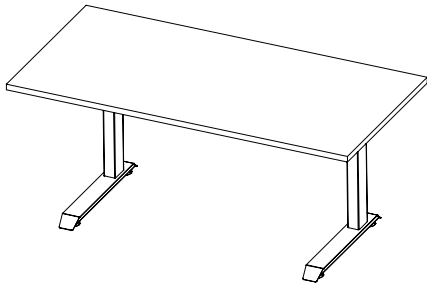

ACTUAL SIZE				LAMINATE	
WIDTH	DEPTH	HEIGHT	WEIGHT	PRICE M1	PRICE H1
84"	36"	29"	132	1,718	1,971
84"	30"	29"	123	1,718	1,971
78"	30"	29"	119	1,718	1,971
72"	30"	29"	116	1,718	1,971
60"	30"	29"	109	1,718	1,971
48"	30"	29"	102	1,485	1,611
84"	24"	29"	113	1,485	1,611
78"	24"	29"	110	1,485	1,611
72"	24"	29"	107	1,485	1,611
60"	24"	29"	102	1,485	1,611
48"	24"	29"	97	1,369	1,433
42"	24"	29"	95	1,369	1,433
36"	24"	29"	92	1,369	1,433
30"	24"	29"	88	1,369	1,433
24"	24"	29"	85	1,369	1,433



ORDER CODE SAMPLE					
ITEM CODE	WIDTH	DEPTH	HEIGHT	LAMINATE	OPTION
MFMCH	72	24	29	H1	LMP

**Features & Specifications**

- Leg provides 1" of leveling
- Laminate codes - M1: 1" LPL, H1: 1" HPL (top only)
- Woodgrain runs width wise if applicable

**No Charge Options**

- Available in all standard laminates
- Available in standard metal paint finishes
- For sizes not listed, specify actual (not nominal) size in product code

**Optional Extra**

- Specify *GL* (left), *GC* (center) and/or *GR* (right) for grommet; add \$76 per grommet
- Specify *LMP* for laminate modesty panel; add \$276

# Mesa 120 Degree 3 Leg Electric C Base Table

MFCTH

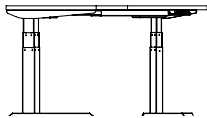
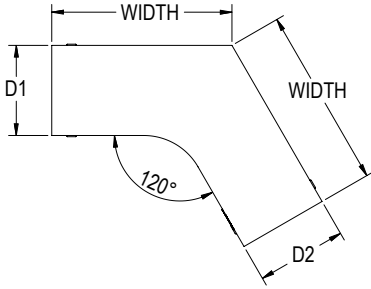
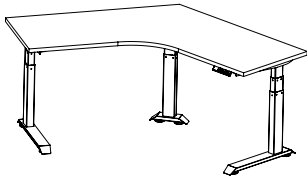

ACTUAL SIZE			LAMINATE	
WIDTH	DEPTH D1	DEPTH D2	PRICE M1	PRICE H1
34"	23" or 29"	23" or 29"	3,836	4,377
40"	23" or 29"	23" or 29"	3,836	4,377
46"	23" or 29"	23" or 29"	3,836	4,377
52"	23" or 29"	23" or 29"	3,836	4,377
58"	23" or 29"	23" or 29"	3,836	4,377



ORDER CODE SAMPLE					
ITEM CODE	WIDTH	DEPTH D1	DEPTH D2	LAMINATE	OPTION
MFCTH	W72	D24	D30	H1	LMP

### Features & Specifications

- Leg provides 1" of leveling
- Laminate codes - M1: 1" LPL, H1: 1" HPL (top only)
- Worksurface may have a seam

### No Charge Options

- Available in all standard laminates
- Available in standard metal paint finishes
- For sizes not listed, specify actual (not nominal) size in product code

### Optional Extra

- Specify *GL* (left), *GC* (center) and/or *GR* (right) for grommet; add \$76 per grommet
- Specify *LMP* for laminate modesty panel; add \$435

PRODUCT MAP  
TABLE OF CONTENTS  
MESA ELECTRIC  
VIVA ELECTRIC  
VIVA MANUAL  
VIVA INCREMENTAL  
VIVA FIXED HEIGHT  
SOHO  
NOLITA  
CONTROLLERS  
www.brc.group

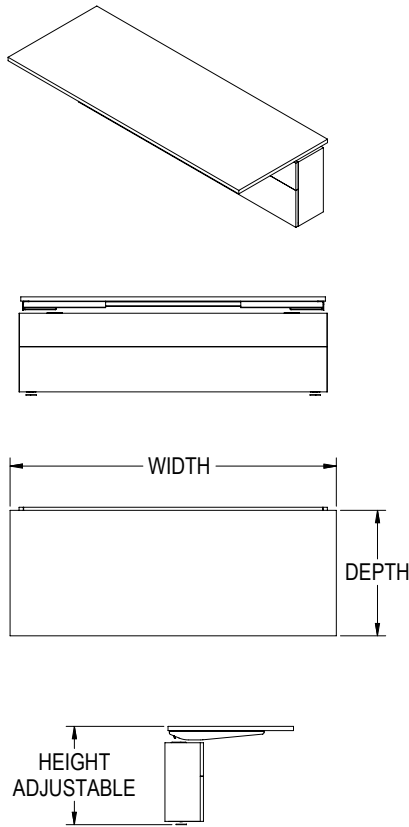

ACTUAL SIZE		LAMINATE	
OVERALL WIDTH	WORKSURFACE DEPTH	PRICE <i>M1</i>	PRICE <i>H1</i>
72"	30"	4,516	4,664
60"	30"	4,469	4,616
48"	30"	4,422	4,569
78"	24"	4,516	4,664
72"	24"	4,469	4,616
60"	24"	4,422	4,569
48"	24"	4,374	4,522

Features & Specifications

No Charge Options



ORDER CODE SAMPLE			
ITEM CODE	WIDTH	DEPTH	LAMINATE
MMWHH	72	24	<i>M1</i>

- For wall mount applications only
- Laminate codes - *M1*: 1" LPL, *H1*: 1" HPL (top only)
- Woodgrain runs width wise if applicable
- Includes wire management from desk to base
- Includes flip down upper front door for wire access
- Laminate base measures 22" high x 10" deep
- Width indicates laminate base width, worksurface is 1" less (0.5" on each side).
- Available in all standard laminates
- Base available in standard metal paint finishes

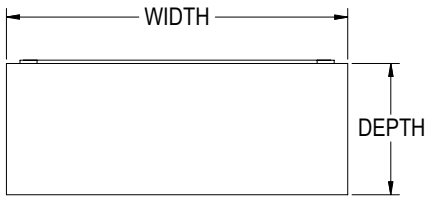
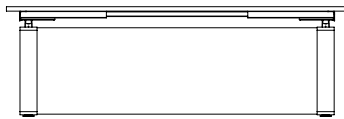
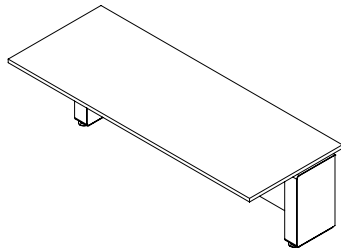

ACTUAL SIZE		LAMINATE	
WIDTH	DEPTH	PRICE <i>M1</i>	PRICE <i>H1</i>
78"	30"	4,144	4,292
72"	30"	4,098	4,244
60"	30"	4,050	4,196
48"	30"	4,002	4,150
78"	24"	4,098	4,244
72"	24"	4,050	4,196
60"	24"	4,002	4,150
48"	24"	3,955	4,102



ORDER CODE SAMPLE			
ITEM CODE	WIDTH	DEPTH	LAMINATE
MMWBH	72	24	<i>M1</i>

Features & Specifications

No Charge Options

- For wall mount applications only
- Laminate codes - *M1*: 1" LPL, *H1*: 1" HPL (top only)
- Woodgrain runs width wise if applicable
- Includes recessed removable front modesty for wire access
- Wire slot in base open across top
- Metal wrapped end bases are 21" high x 12.5" deep with laminate side covers
- Recessed center modesty is 4" deep.
- Worksurface is 6" wider (3" each side) than lower base width
- Available in all standard laminates
- Base available in standard metal paint finishes

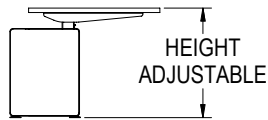
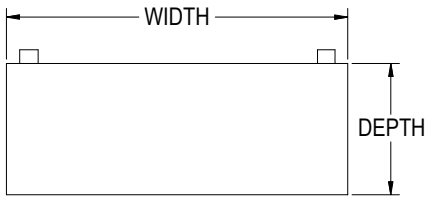
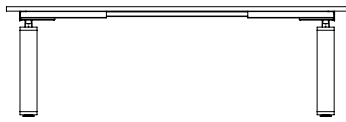
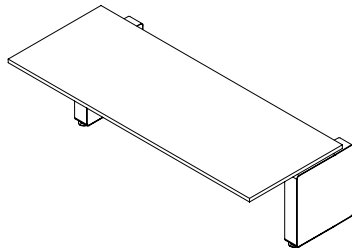

ACTUAL SIZE		LAMINATE	
WIDTH	DEPTH	PRICE <i>M1</i>	PRICE <i>H1</i>
78"	30"	4,455	4,614
72"	30"	4,406	4,563
60"	30"	4,354	4,511
48"	30"	4,303	4,462
78"	24"	4,406	4,563
72"	24"	4,354	4,511
60"	24"	4,303	4,462
48"	24"	4,252	4,410



ORDER CODE SAMPLE				
ITEM CODE	WIDTH	DEPTH	LAMINATE	OPTION
MB1NH	72	24	<i>M1</i>	<i>LMP</i>

Features & Specifications

- Laminate codes - *M1*: 1" LPL, *H1*: 1" HPL (top only)
- Woodgrain runs width wise if applicable
- Metal wrapped end bases are 21" high x 12.5" deep with laminate side covers
- Worksurface is 6" wider (3" each side) than lower base width

No Charge Options

- Available in all standard laminates
- Base available in standard metal paint finishes

Optional Extra

- Specify *GL* (left), *GC* (center) and/or *GR* (right) for grommet; add \$76 per grommet
- Specify *LMP* for laminate modesty panel; add \$276

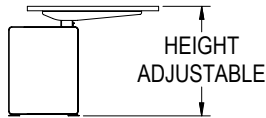
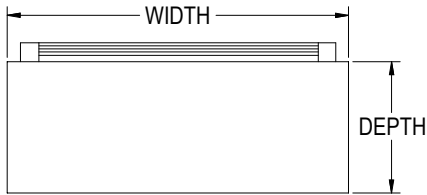
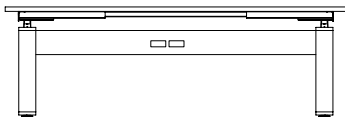
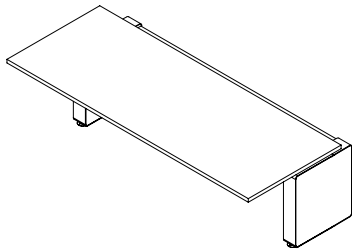

ACTUAL SIZE		LAMINATE	
WIDTH	DEPTH	PRICE <i>M1</i>	PRICE <i>H1</i>
78"	30"	6,255	6,414
72"	30"	6,206	6,363
60"	30"	6,154	6,311
48"	30"	6,103	6,262
78"	24"	6,206	6,363
72"	24"	6,154	6,311
60"	24"	6,103	6,262
48"	24"	6,052	6,210

Features & Specifications

No Charge Options

Optional Extra



ORDER CODE SAMPLE				
ITEM CODE	WIDTH	DEPTH	LAMINATE	OPTION
MB1PH	72	24	<i>M1</i>	<i>1D</i>

- Laminate codes - *M1*: 1" LPL, *H1*: 1" HPL (top only)
- Woodgrain runs width wise if applicable
- Metal wrapped end bases are 21" high x 12.5" deep with laminate side covers
- Worksurface is 6" wider (3" each side) than lower base width
- Power spine is single sided towards the worksurface
- Widths 48" - 60" contain two duplex outlets
- Widths 66" - 72" contain four duplex outlets

- Available in all standard laminates
- Base & power spine available in standard metal paint finishes

- Specify *GL* (left), *GC* (center) and/or *GR* (right) for grommet; add \$76 per grommet
- Felt (MJFTN) or Acrylic (MJATN) screens available
- Two knock outs provided for data jacks are available. Specify option code '1D' and add \$175

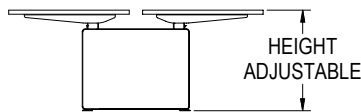
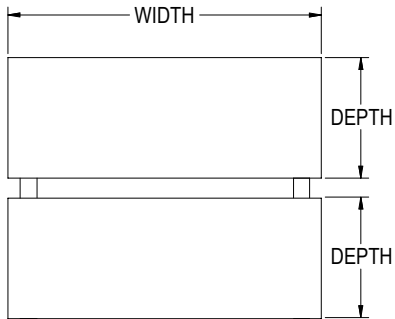
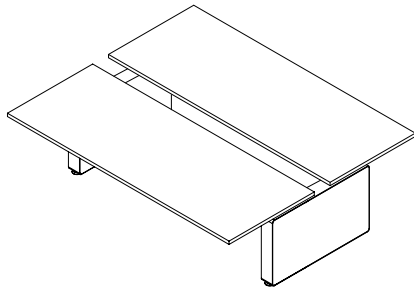

ACTUAL SIZE		LAMINATE	
WIDTH	DEPTH	PRICE <i>M1</i>	PRICE <i>H1</i>
78"	30"	5,880	6,039
72"	30"	5,831	5,988
60"	30"	5,779	5,936
48"	30"	5,728	5,887
78"	24"	5,831	5,988
72"	24"	5,779	5,936
60"	24"	5,728	5,887
48"	24"	5,677	5,835



ORDER CODE SAMPLE				
ITEM CODE	WIDTH	DEPTH	LAMINATE	OPTION
MB2NH	72	24	<i>M1</i>	<i>LMP</i>

Features & Specifications

- Laminate codes - *M1*: 1" LPL, *H1*: 1" HPL (top only)
- Woodgrain runs width wise if applicable
- Metal wrapped end bases are 21" high x 12.5" deep with laminate side covers
- Worksurface is 6" wider (3" each side) than lower base width

No Charge Options

- Available in all standard laminates
- Base available in standard metal paint finishes

Optional Extra

- Specify *GL* (left), *GC* (center) and/or *GR* (right) for grommet; add \$76 per grommet
- Specify *LMP* for laminate modesty panels (one per worksurface); add \$552

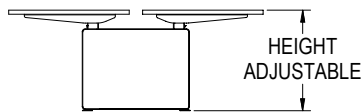
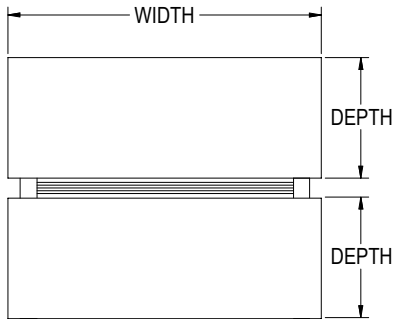
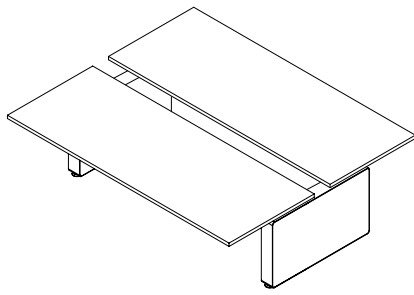

ACTUAL SIZE		LAMINATE	
WIDTH	DEPTH	PRICE M1	PRICE H1
78"	30"	7,680	7,839
72"	30"	7,631	7,788
60"	30"	7,579	7,736
48"	30"	7,528	7,687
78"	24"	7,631	7,788
72"	24"	7,579	7,736
60"	24"	7,528	7,687
48"	24"	7,477	7,635



ORDER CODE SAMPLE				
ITEM CODE	WIDTH	DEPTH	LAMINATE	OPTION
MB2PH	72	24	M1	1D

Features & Specifications

- Laminate codes - M1: 1" LPL, H1: 1" HPL (top only)
- Woodgrain runs width wise if applicable
- Metal wrapped end bases are 21" high x 12.5" deep with laminate side covers
- Worksurface is 6" wider (3" each side) than lower base width
- Power spine is double sided (outlets on each side facing the users)
- Widths 48" - 60" contain two duplex outlets
- Widths 66" - 72" contain four duplex outlets

No Charge Options

- Available in all standard laminates
- Base & power spine available in standard metal paint finishes

Optional Extra

- Specify GL (left), GC (center) and/or GR (right) for grommet; add \$76 per grommet
- Felt (MJFTN) or Acrylic (MJATN) screens available
- Two knock outs provided for data jacks are available. Specify option code '1D' and add \$175

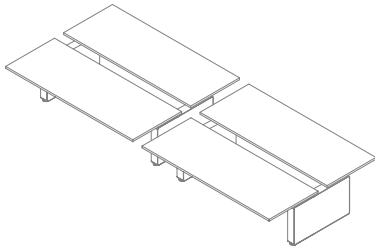
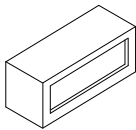
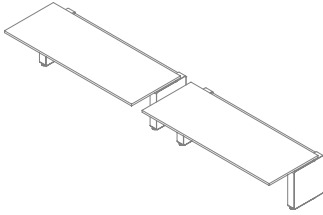
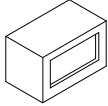

### MBC1N - Single Sided Benching Connector

FEATURES & SPECIFICATIONS	PRICE
<ul style="list-style-type: none"> <li>• Use to connect two or more single benching stations side by side</li> <li>• Accommodates run through power capability</li> <li>• Available in all standard laminates</li> </ul>	985

### MBC2N - Dual Sided Benching Connector

FEATURES & SPECIFICATIONS	PRICE
<ul style="list-style-type: none"> <li>• Use to connect two or more dual benching stations side by side</li> <li>• Accommodates run through power capability</li> <li>• Available in all standard laminates</li> </ul>	1395



ORDER CODE SAMPLE
ITEM CODE
MBC1N

# Viva

## Premium Electric Height Adjustable Tables

### Standard Features:

- LPL & HPL Worksurfaces available with overall height adjustability from 22.25" to 48.25"
- Dual motor with a lift capacity up to 300lbs and 1.5" [38.1mm] per second travel
- Anti collision piezoelectric sensor stops movement when obstruction is encountered
- Power ratings: 450W, 3.75 Amp working, 0.1W standby. 125" Cord length
- C Base two and three leg table configurations
- Whisper quiet motion at only 55 decibels
- Foot design matches all Viva line product

### Optional Features:

- Bluetooth with Desk Control App
- Rechargeable Battery for wireless operation
- Multiple handset options
- Left, right and center grommets
- Keyboard tray adaptable
- Modesty panel is 10" high

### Basic Dimensions:

#### C-LEG

- Column: 2" x 3" [50.8mm x 76.2mm]
- Foot: 2.88" x 24" [73.2mm x 609.6mm]
- Foot height: 1.375" [34.9mm]

### Finishes:

#### BASE

- Powdercoat silver, black & white

#### WORKSURFACE

- 1" or 1.5" LPL & HPL in all standard BRC laminates

### General Product Overview:

Table bases are metal and have a durable scratch resistant, heat cured powder coat paint finish. Metal uprights are of 14 gauge tubing 2" thick by 3" wide. Low profile foot is constructed of drawn steel, with waterfall front and back edges. The interior of the foot is double walled with 11 gauge steel supports. These feet have easy to access levelers for ease of installation and balancing. ANSI Bifma and CGSB (Canadian General Standards Board) tested and qualified. This ensures that BRC products adhere to the highest standards of quality and durability in North America. UL Certified electronics.

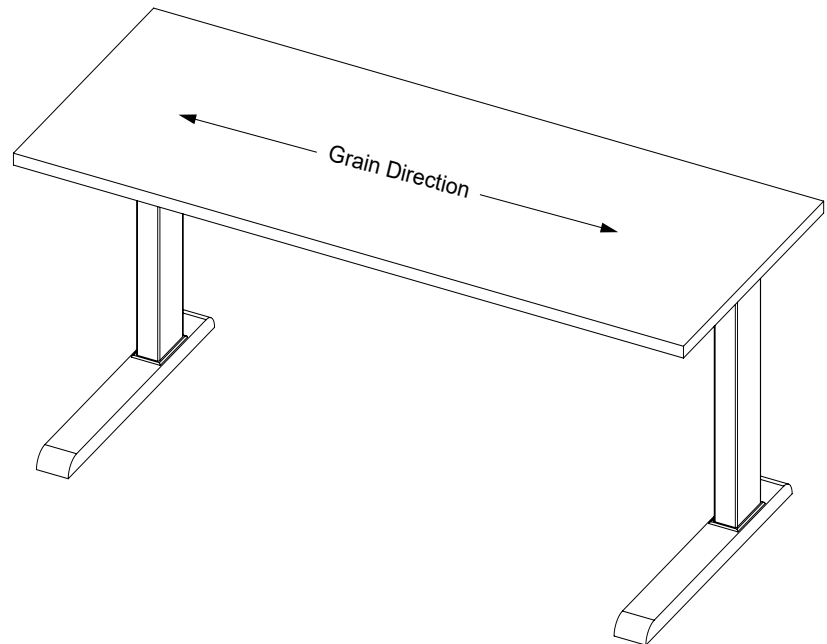

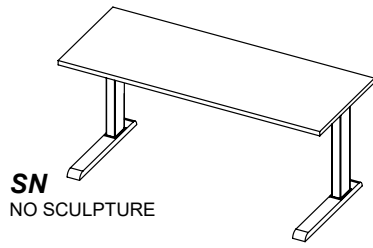

**SN**  
NO SCULPTURE

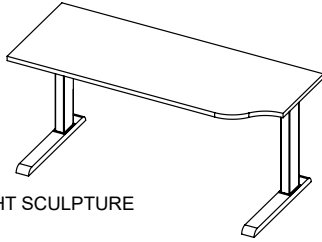

**SR**  
RIGHT SCULPTURE

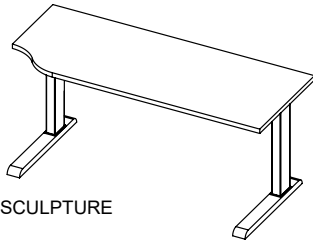

**SL**  
LEFT SCULPTURE

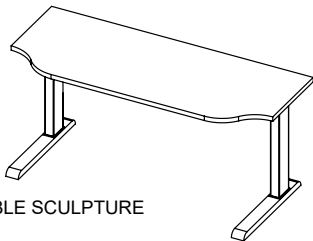

**SD**  
DOUBLE SCULPTURE

Features & Specifications

No Charge Options

Optional Extra

ACTUAL SIZE			LAMINATE	
WIDTH	DEPTH	WEIGHT/CUBE	PRICE M1	PRICE H1
82"	35"	120/72	4,004	4,051
82"	29"	120/72	3,548	3,592
76"	29"	110/72	3,382	3,435
70"	29"	110/72	3,197	3,253
64"	29"	110/60	3,197	3,253
58"	29"	110/60	3,076	3,144
46"	29"	105/48	2,971	3,015
40"	29"	95/48	2,819	2,870
34"	29"	85/36	2,788	2,833
28"	29"	75/30	2,743	2,795
94"	23"	140/85	4,004	4,051
82"	23"	120/76	3,396	3,442
76"	23"	115/72	3,228	3,282
70"	23"	115/72	3,045	3,100
64"	23"	105/60	2,925	2,992
58"	23"	100/48	2,819	2,863
46"	23"	90/48	2,667	2,719
40"	23"	80/36	2,636	2,679
34"	23"	70/30	2,589	2,642
28"	23"	70/30	2,575	2,627



ORDER CODE SAMPLE					
ITEM CODE	WIDTH	DEPTH	LAMINATE	SCULPTURE	OPTION
MWEE	70	23	H1	SN	LMP

- Leg provides 1" of leveling
- Laminate codes - M1: 1" LPL, H1: 1" HPL (top only)
- Specify sculpture - 'SN' - none, 'SR' - right, 'SL' - left, or 'SD' - double
- Woodgrain runs horizontally if applicable
- Sculpture is 6" deep (eg: 23" depth is 17" at edge when sculptured)

- Available in all standard laminates
- Available in standard metal paint finishes
- For sizes not listed, specify actual (not nominal) size in product code

- Specify GL (left), GC (center) and/or GR (right) for grommet; add \$76 per grommet
- Specify LMP for laminate modesty panel; add \$276
- 6" Bow fronts for tables 58" and larger available; add BF to code and \$213

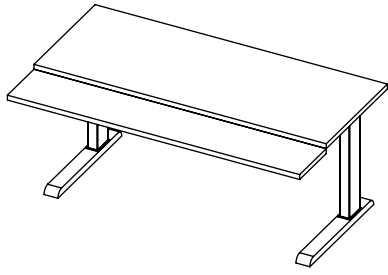

DUAL ARM KEYBOARD

ACTUAL SIZE			LAMINATE	
WIDTH	DEPTH	WEIGHT/CUBE	PRICE M1	PRICE H1
58"	35"	115/70	4,604	4,871
58"	29"	115/70	4,604	4,871
46"	29"	105/60	4,296	4,537
40"	29"	100/60	4,182	4,414



ORDER CODE SAMPLE				
ITEM CODE	WIDTH	DEPTH	LAMINATE	OPTION
MTEE	58	29	H1	KW(FOC)

Features & Specifications

No Charge Options

Optional Extra

- Leg provides 1" of leveling
- Laminate codes - M1: 1" LPL, H1: 1" HPL (top only)
- Default KBKW-27 dual arm keyboard mechanism has a range of 9.5" Above and 6.5" Below work-surface with 15 degrees positive or negative tilt
- Woodgrain runs horizontally if applicable
- Available in all standard laminates
- Available in standard metal paint finishes
- For sizes not listed, specify actual (not nominal) size in product code
- Specify *GL* (left), *GC* (center) and/or *GR* (right) for grommet; add \$76 per grommet
- Specify *LMP* for laminate modesty panel; add \$276
- Sliding keyboard with 5" of adjustment; add *KW(FOC)* to code and add \$418

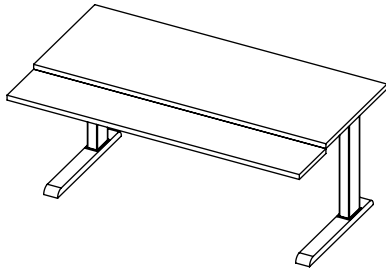

SINGLE ARM KEYBOARD

ACTUAL SIZE			LAMINATE	
WIDTH	DEPTH	WEIGHT/CUBE	PRICE M1	PRICE H1
34"	29"	95/50	3,766	3,960
28"	29"	89/40	3,721	4,065

Features & Specifications

No Charge Options

Optional Extra



ORDER CODE SAMPLE				
ITEM CODE	WIDTH	DEPTH	LAMINATE	OPTION
MTEESA	34	29	H1	KW(FOC)

- Leg provides 1" of leveling
- Laminate codes - M1: 1" LPL, H1: 1" HPL (top only)
- Default KBSS single arm keyboard mechanism has a range of 6" above and 6" below worksurface with 15 degrees positive or negative tilt
- Woodgrain runs horizontally if applicable
- Available in all standard laminates
- Available in standard metal paint finishes
- For sizes not listed, specify actual (not nominal) size in product code
- Specify *GL* (left), *GC* (center) and/or *GR* (right) for grommet; add \$76 per grommet
- Specify *LMP* for laminate modesty panel; add \$276



**A1**  
STRAIGHT FRONT  
CURVE BACK



**A2**  
CURVE FRONT  
CURVE BACK



**B1**  
STRAIGHT FRONT  
STRAIGHT BACK

ACTUAL SIZE				LAMINATE	
WIDTH	DEPTH	USER WIDTH	WEIGHT/ CUBE	PRICE M1	PRICE H1
46"	29"	25"	105/60	3,655	3,807
40"	29"	17"	105/60	3,579	3,732
46"	23"	34"	105/60	3,662	3,716
40"	23"	25"	100/60	3,509	3,655
34"	23"	17"	90/54	3,206	3,350
28"	23"	9"	90/54	3,130	3,275



ORDER CODE SAMPLE					
ITEM CODE	WIDTH	DEPTH	LAMINATE	STYLE	OPTION
MTKEE	46	29	H1	A1	LMP

Features & Specifications

- Leg provides 1" of leveling
- Laminate codes - M1: 1" LPL, H1: 1" HPL (top only)
- Specify worksurface style: 'A1', 'A2' or 'B1'

No Charge Options

- Available in all standard laminates
- Available in standard metal paint finishes
- For sizes not listed, specify actual (not nominal) size in product code

Optional Extra

- Specify GL (left), GC (center) and/or GR (right) for grommet; add \$76 per grommet
- Specify LMP for laminate modesty panel; add \$276

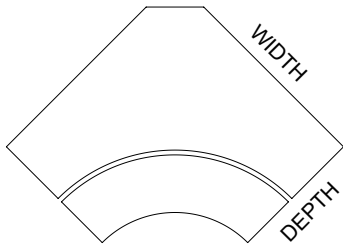
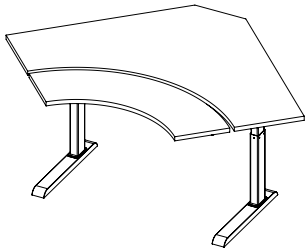

ACTUAL SIZE			LAMINATE	
WIDTH	DEPTH	WEIGHT/CUBE	PRICE M1	PRICE H1
46"	29"	105/60	4,680	4,949
46"	23"	105/60	4,604	4,871
40"	23"	100/60	4,534	4,795
40"	17"	100/60	4,534	4,795

Features & Specifications

No Charge Options

Optional Extra



ORDER CODE SAMPLE				
ITEM CODE	WIDTH	DEPTH	LAMINATE	OPTION
MTKKEVC	46	29	H1	LMP

- Leg provides 1" of leveling
- Laminate codes - M1: 1" LPL, H1: 1" HPL (top only)
- Default KBKW dual arm keyboard mechanism has a range of 9.5" above and 6.5" below worksurface with 15 degrees positive or negative tilt
- Available in all standard laminates
- Available in standard metal paint finishes
- For sizes not listed, specify actual (not nominal) size in product code
- Straight front available; add option SF to product code
- Specify GL (left), GC (center) and/or GR (right) for grommet; add \$76 per grommet
- Specify LMP for laminate modesty panel; add \$276
- Sliding keyboard with 5" of adjustment; add KW(FOC) to code and add \$458

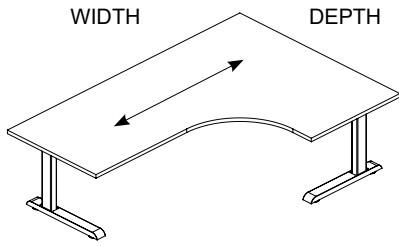

**EL**  
EXTENDED LEFT

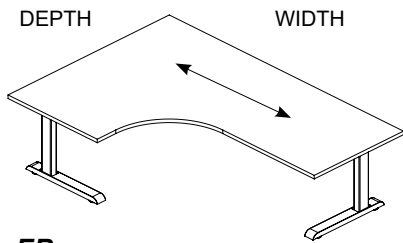

**ER**  
EXTENDED RIGHT

**23" DEEP RETURN ON BOTH SIDES**

ARROWS INDICATE GRAIN DIRECTION  
(IF APPLICABLE)

ACTUAL SIZE					LAMINATE	
WIDTH	DEPTH	RETURN	RADIUS	WT/CUBE	PRICE M1	PRICE H1
82"	58"	23"	18"	215/18.5	5,340	5,680
76"	58"	23"	18"	202/17.2	5,296	5,637
70"	58"	23"	18"	189/15.9	5,160	5,504
64"	58"	23"	18"	176/14.6	5,061	5,402
82"	52"	23"	18"	215/18.5	5,061	5,402
76"	52"	23"	18"	202/17.2	5,061	5,402
70"	52"	23"	18"	189/15.9	5,010	5,352
64"	52"	23"	18"	176/14.6	5,010	5,352
58"	52"	23"	18"	149/11.0	4,984	5,327
82"	46"	23"	18"	215/18.5	4,970	5,314
76"	46"	23"	18"	202/17.2	4,970	5,314
70"	46"	23"	18"	189/15.9	4,951	5,294
64"	46"	23"	18"	176/14.6	4,951	5,294
58"	46"	23"	18"	149/11.0	4,919	5,259

ARROWS INDICATE GRAIN DIRECTION  
(IF APPLICABLE)



ORDER CODE SAMPLE							
ITEM CODE	RETURN	WIDTH	DEPTH	RETURN	LAMINATE	HAND	OPTION
MWEEC	23	70	46	23	M1	EL	GC

**Features & Specifications**

**No Charge Options**

**Optional Extra**

- Leg provides 1" of leveling
- Laminate codes - M1: 1" LPL, H1: 1" HPL (top only)
- Woodgrain runs horizontally on the longest side of the table
- Specify style - 'ER' - extended right, or 'EL' - extended left
- Available in all standard laminates
- Available in standard metal paint finishes
- For sizes not listed, specify actual (not nominal) size in product code
- For straight front instead of standard curved, add code SF to options
- Specify GL (left), GC (center) and/or GR (right) for grommet; add \$76 per grommet
- Specify LMP for laminate modesty panel; add \$340

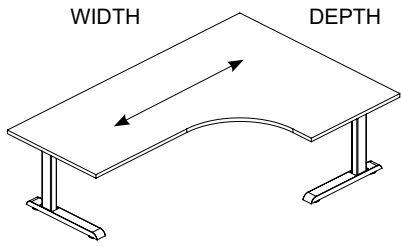

**EL**  
EXTENDED LEFT

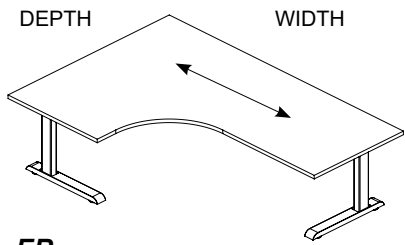

**ER**  
EXTENDED RIGHT

**29" DEEP RETURN ON BOTH SIDES**

ARROWS INDICATE GRAIN DIRECTION (IF APPLICABLE)

ACTUAL SIZE					LAMINATE	
WIDTH	DEPTH	RETURN	RADIUS	WT/CUBE	PRICE M1	PRICE H1
82"	58"	29"	18"	215/18.5	5,354	5,697
76"	58"	29"	18"	202/17.2	5,310	5,654
70"	58"	29"	18"	189/15.9	5,173	5,517
64"	58"	29"	18"	176/14.6	5,075	5,420
82"	52"	29"	18"	215/18.5	5,075	5,420
76"	52"	29"	18"	202/17.2	5,075	5,420
70"	52"	29"	18"	189/15.9	5,023	5,367
64"	52"	29"	18"	176/14.6	5,023	5,367
58"	52"	29"	18"	149/11.0	4,999	5,342
82"	46"	29"	18"	215/18.5	4,986	5,329
76"	46"	29"	18"	202/17.2	4,986	5,329
70"	46"	29"	18"	189/15.9	4,967	5,306
64"	46"	29"	18"	176/14.6	4,967	5,306
58"	46"	29"	18"	149/11.0	4,932	5,280



ORDER CODE SAMPLE							
ITEM CODE	RETURN	WIDTH	DEPTH	RETURN	LAMINATE	HAND	OPTION
MWEEC	29	70	46	29	M1	EL	GC

**Features & Specifications**

**No Charge Options**

**Optional Extra**

- Leg provides 1" of leveling
- Laminate codes - M1: 1" LPL, H1: 1" HPL (top only)
- Woodgrain runs horizontally on the longest side of the table
- Specify style - 'ER' - extended right, or 'EL' - extended left
- Available in all standard laminates
- Available in standard metal paint finishes
- For sizes not listed, specify actual (not nominal) size in product code
- For straight front instead of standard curved, add code SF to options
- Specify GL (left), GC (center) and/or GR (right) for grommet; add \$76 per grommet
- Specify LMP for laminate modesty panel; add \$340

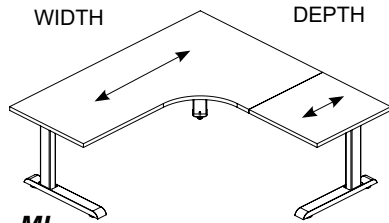

**ML**  
MAIN LEFT EXTENDED

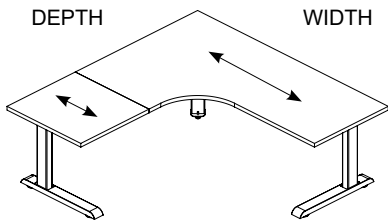

**MR**  
MAIN RIGHT EXTENDED

**29" DEEP RETURN ON BOTH SIDES**

**MAIN WORKSURFACE DETERMINES  
HANDEDNESS, SEAM DICTATES  
RETURN**

ARROWS INDICATE GRAIN DIRECTION  
(IF APPLICABLE)

**Features & Specifications**

**No Charge Options**

**Optional Extra**

ACTUAL SIZE					LAMINATE	
WIDTH	DEPTH	RETURN	RADIUS	WT/CUBE	PRICE M1	PRICE H1
64"	64"	29"	18"	185/14.6	5,061	5,402
64"	70"	29"	18"	190/14.8	5,061	5,402
64"	76"	29"	18"	194/15.0	5,061	5,402
64"	82"	29"	18"	198/15.2	5,061	5,402
64"	88"	29"	18"	203/15.4	5,061	5,402
64"	94"	29"	18"	207/15.6	5,061	5,402
70"	64"	29"	18"	190/15.8	5,160	5,504
70"	70"	29"	18"	189/15.9	5,160	5,504
70"	76"	29"	18"	198/16.0	5,160	5,504
70"	82"	29"	18"	203/16.2	5,160	5,504
70"	88"	29"	18"	207/16.4	5,160	5,504
70"	94"	29"	18"	211/16.8	5,160	5,504
76"	64"	29"	18"	194/17.0	5,296	5,637
76"	70"	29"	18"	198/17.1	5,296	5,637
76"	76"	29"	18"	202/17.2	5,296	5,637
76"	82"	29"	18"	207/17.4	5,296	5,637
76"	88"	29"	18"	211/17.6	5,296	5,637
76"	94"	29"	18"	216/17.8	5,296	5,637
82"	64"	29"	18"	198/18.0	5,340	5,680
82"	70"	29"	18"	203/18.2	5,340	5,680
82"	76"	29"	18"	207/18.4	5,340	5,680
82"	82"	29"	18"	211/18.6	5,340	5,680
82"	88"	29"	18"	216/18.8	5,340	5,680
82"	94"	29"	18"	220/19.0	5,340	5,680
94"	64"	29"	18"	207/19.2	5,505	5,846
94"	70"	29"	18"	211/19.4	5,505	5,846
94"	76"	29"	18"	216/19.6	5,505	5,846
94"	82"	29"	18"	220/19.8	5,505	5,846
94"	88"	29"	18"	224/19.9	5,505	5,846
94"	94"	29"	18"	225/20.1	5,505	5,846



ORDER CODE SAMPLE							
ITEM CODE	RETURN	WIDTH	DEPTH	RETURN	LAMINATE	HAND	OPTION
MWEEL	29	70	76	29	M1	ML	GC LMP

- Leg provides 1" of leveling
- Laminate codes - M1: 1" LPL, H1: 1" HPL (top only)
- Two piece worksurface will have a seam as shown

- Available in all standard laminates
- Available in standard metal paint finishes
- For sizes not listed, specify actual (not nominal) size in product code

- Specify GL (left), GC (center) and/or GR (right) for grommet; add \$76 per grommet
- Specify LMP for laminate modesty panel (set of 2); add \$340 total



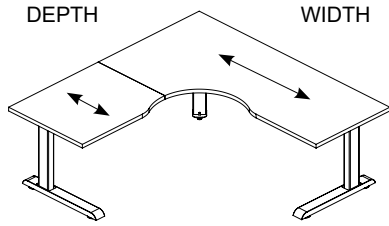

**MR**  
MAIN RIGHT EXTENDED

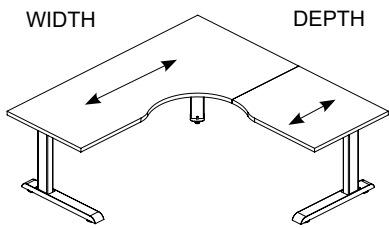

**ML**  
MAIN LEFT EXTENDED

**29" DEEP RETURN ON BOTH SIDES**

**MAIN WORKSURFACE DETERMINES  
HANDEDNESS, SEAM DICTATES  
RETURN**

ARROWS INDICATE GRAIN DIRECTION  
(IF APPLICABLE)

**Features & Specifications**

**No Charge Options**

**Optional Extra**

ACTUAL SIZE				LAMINATE	
WIDTH	DEPTH	RETURN	WT/CUBE	PRICE M1	PRICE H1
64"	64"	29"	185/14.6	5,061	5,402
64"	70"	29"	190/14.8	5,061	5,402
64"	76"	29"	194/15.0	5,061	5,402
64"	82"	29"	198/15.2	5,061	5,402
64"	88"	29"	203/15.4	5,061	5,402
64"	94"	29"	207/15.6	5,061	5,402
70"	64"	29"	190/15.8	5,160	5,504
70"	70"	29"	189/15.9	5,160	5,504
70"	76"	29"	198/16.0	5,160	5,504
70"	82"	29"	203/16.2	5,160	5,504
70"	88"	29"	207/16.4	5,160	5,504
70"	94"	29"	211/16.8	5,160	5,504
76"	64"	29"	194/17.0	5,296	5,637
76"	70"	29"	198/17.1	5,296	5,637
76"	76"	29"	202/17.2	5,296	5,637
76"	82"	29"	207/17.4	5,296	5,637
76"	88"	29"	211/17.6	5,296	5,637
76"	94"	29"	216/17.8	5,296	5,637
82"	64"	29"	198/18.0	5,340	5,680
82"	70"	29"	203/18.2	5,340	5,680
82"	76"	29"	207/18.4	5,340	5,680
82"	82"	29"	211/18.6	5,340	5,680
82"	88"	29"	216/18.8	5,340	5,680
82"	94"	29"	220/19.0	5,340	5,680
94"	64"	29"	207/19.2	5,505	5,846
94"	70"	29"	211/19.4	5,505	5,846
94"	76"	29"	216/19.6	5,505	5,846
94"	82"	29"	220/19.8	5,505	5,846
94"	88"	29"	224/19.9	5,505	5,846
94"	94"	29"	225/20.1	5,505	5,846



**ORDER CODE SAMPLE**

ITEM CODE	RETURN	WIDTH	DEPTH	RETURN	LAMINATE	HAND	OPTION
MWEELC	29	70	88	29	M1	ML	GC LMP

- Leg provides 1" of leveling
- Laminate codes - M1: 1" LPL, H1: 1" HPL (top only)
- Two piece worksurface will have a seam as shown

- Available in all standard laminates
- Available in standard metal paint finishes
- For sizes not listed, specify actual (not nominal) size in product code

- Specify *GL* (left), *GC* (center) and/or *GR* (right) for grommet; add \$76 per grommet
- Specify *LMP* for laminate modesty panel (set of 2); add \$340 total

# Viva

## Manually Operated Height Adjustable Tables

### Standard Features:

- LPL & HPL worksurfaces with overall height adjustability from 24" to 36"
- Top access crank handle & grommets are standard (UTS)
- Handle turns 6 revolutions for each 1" of travel
- C Base two and three leg configurations
- Foot design matches all Viva line products
- No electrical power requirements

### Optional Features:

- Left, right and center grommets
- Undermount crank handle position

### Basic Dimensions:

#### C-LEG

- Column: 2.0" x 4.0" [51mm x 102mm]
- Foot: 2.88" x 24" [73.2mm x 609.6mm]
- Foot height: 1.375" [34.9mm]

#### FRAME

- 1.25" x 1.25" [32 x 32mm] spans full width

### Finishes:

#### BASE

- Powdercoat silver, black & white

#### WORKSURFACE

- 1" & 1.5" LPL & HPL in all standard BRC laminates

### General Product Overview:

Table bases are metal and have a durable scratch resistant, heat cured powder coat paint finish. Metal uprights are of 14 gauge tubing 2" thick by 4" wide. On all tables, inserts are of 14 gauge tubing and incorporate Teflon-like slides for smooth operation and low maintenance. All table bases have a 1" x 3" horizontal modesty bar of 16 gauge steel attached to each leg to assure strength and stability throughout the entire range of motion. Low profile foot is constructed of drawn steel, with waterfall front and back edges. The interior of the foot is double walled with 11 gauge steel supports. These feet have easy to access levelers for ease of installation and balancing.

ANSI Bifma and CGSB (Canadian General Standards Board) tested and qualified. This ensures that BRC products adhere to the highest standards of quality and durability in North America.

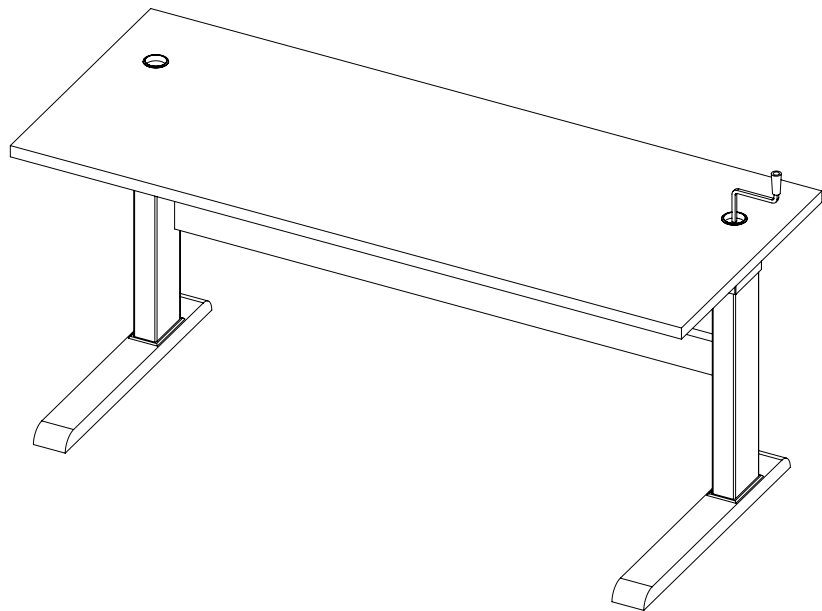

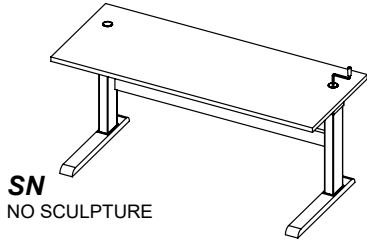

**SN**  
NO SCULPTURE

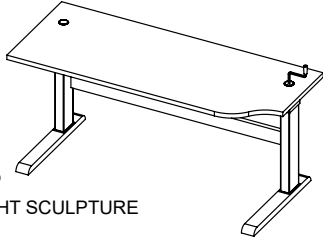

**SR**  
RIGHT SCULPTURE

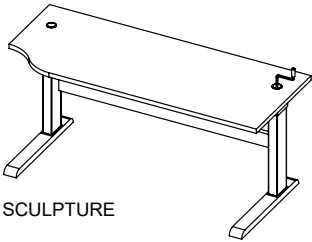

**SL**  
LEFT SCULPTURE

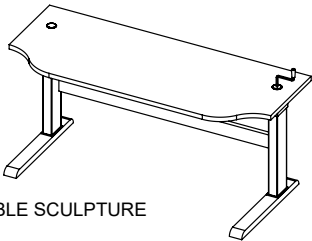

**SD**  
DOUBLE SCULPTURE

Features & Specifications

No Charge Options

Optional Extra

ACTUAL SIZE			LAMINATE	
WIDTH	DEPTH	WEIGHT/CUBE	PRICE M1	PRICE H1
94"	35"	140/75	2,596	2,847
82"	29"	120/72	2,139	2,377
76"	29"	110/72	2,020	2,216
70"	29"	100/72	1,866	2,033
64"	29"	110/60	1,822	1,974
58"	29"	110/60	1,768	1,926
52"	29"	110/60	1,768	1,926
46"	29"	105/48	1,683	1,798
40"	29"	95/48	1,540	1,653
34"	29"	85/36	1,510	1,617
28"	29"	75/30	1,470	1,577
82"	23"	120/72	2,041	2,353
76"	23"	115/72	2,041	2,203
70"	23"	115/72	1,791	1,943
64"	23"	110/66	1,700	1,829
58"	23"	105/60	1,647	1,768
52"	23"	105/54	1,647	1,768
46"	23"	100/48	1,601	1,707
40"	23"	90/48	1,456	1,563
34"	23"	80/36	1,426	1,525
28"	23"	70/30	1,394	1,487
22"	23"	70/30	1,394	1,487



ORDER CODE SAMPLE					
ITEM CODE	WIDTH	DEPTH	LAMINATE	SCULPTURE	OPTION
MWCC	70	23	H1	SN	LMP

- Leg provides 1" of leveling
- Laminate codes - M1: 1" LPL, H1: 1" HPL (top only)
- Specify sculpture: 'SN' - none, 'SR' - right, 'SL' - left, or 'SD' - double
- Sculpture is 6" deep (eg: 23" depth is 17" at edge when sculptured)
- Top access crank handle/grommets are standard. Undermount option (UTS) does not remove top access holes
- Available in all standard laminates
- Available in standard metal paint finishes
- For sizes not listed, specify actual (not nominal) size in product code
- Specify GL (left), GC (center) and/or GR (right) for grommet; add \$76 per grommet
- Specify LMP for laminate modesty panel; add \$276
- For under surface handle operation add 'UTS' to product code; add \$236

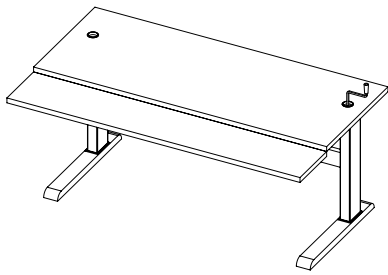

DUAL ARM KEYBOARD

ACTUAL SIZE			LAMINATE	
WIDTH	DEPTH	WEIGHT/CUBE	PRICE M1	PRICE H1
58"	35"	115/70	3,081	3,350
58"	29"	115/70	3,024	3,197
46"	29"	105/60	2,774	3,015
40"	29"	100/60	2,663	2,894

Features & Specifications

No Charge Options

Optional Extra



ORDER CODE SAMPLE				
ITEM CODE	WIDTH	DEPTH	LAMINATE	OPTION
MTCC	58	29	H1	LMP

- Leg provides 1" of leveling
- Laminate codes - M1: 1" LPL, H1: 1" HPL (top only)
- Default KBKW-27 dual arm keyboard mechanism has a range of 9.5" above and 6.5" below work-surface with 15 degrees positive or negative tilt
- Top access crank handle/grommets are standard. Undermount option (UTS) does not remove top access holes
- Available in all standard laminates
- Available in standard metal paint finishes
- For sizes not listed, specify actual (not nominal) size in product code
- Specify *GL* (left), *GC* (center) and/or *GR* (right) for grommet; add \$76 per grommet
- Specify *LMP* for laminate modesty panel; add \$276
- Sliding keyboard with 5" of adjustment; add *KW(FOC)* to code and add \$418

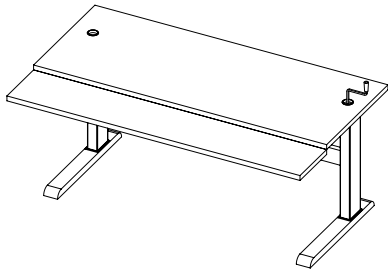

SINGLE ARM KEYBOARD

ACTUAL SIZE			LAMINATE	
WIDTH	DEPTH	WEIGHT/CUBE	PRICE M1	PRICE H1
45"	29"	95/50	2,243	2,437
28"	29"	89/40	2,203	2,391

Features & Specifications

No Charge Options

Optional Extra



ORDER CODE SAMPLE				
ITEM CODE	WIDTH	DEPTH	LAMINATE	OPTION
MTCCSA	28	29	H1	LMP

- Leg provides 1" of leveling
- Laminate codes - M1: 1" LPL, H1: 1" HPL (top only)
- Default KBSS single arm keyboard mechanism has a range of 5.8" above and 8.2" below worksurface with 15 degrees positive or negative tilt
- Top access crank handle/grommets are standard. Undermount option (UTS) does not remove top access holes
- Available in all standard laminates
- Available in standard metal paint finishes
- For sizes not listed, specify actual (not nominal) size in product code
- Specify *GL* (left), *GC* (center) and/or *GR* (right) for grommet; add \$76 per grommet
- Specify *LMP* for laminate modesty panel; add \$276

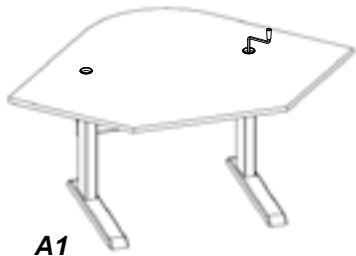

**A1**  
STRAIGHT FRONT  
CURVE BACK

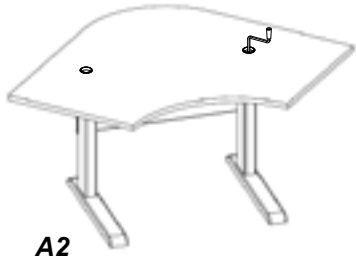

**A2**  
CURVE FRONT  
CURVE BACK

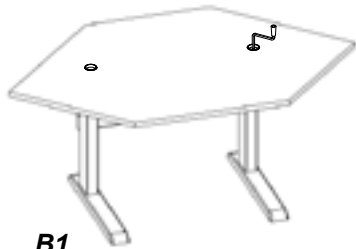

**B1**  
STRAIGHT FRONT  
STRAIGHT BACK

ACTUAL SIZE				LAMINATE	
WIDTH	DEPTH	USER WIDTH	WEIGHT/ CUBE	PRICE M1	PRICE H1
46"	29"	25"	105/60	2,139	2,194
40"	29"	17"	105/60	1,479	1,768
46"	23"	34"	105/60	2,139	2,194
40"	23"	25"	100/60	1,479	1,768
34"	23"	17"	90/54	1,340	1,617
28"	23"	9"	90/54	1,340	1,617



ORDER CODE SAMPLE					
ITEM CODE	WIDTH	DEPTH	LAMINATE	STYLE	OPTION
MTKCC	46	29	H1	A1	LMP

Features & Specifications

- Leg provides 1" of leveling
- Laminate codes - M1: 1" LPL, H1: 1" HPL (top only)
- Specify worksurface style: 'A1', 'A2' or 'B1'
- Top access crank handle/grommets are standard. Undermount option (UTS) does not remove top access holes

No Charge Options

- Available in all standard laminates
- Available in standard metal paint finishes
- For sizes not listed, specify actual (not nominal) size in product code

Optional Extra

- Specify GL (left), GC (center) and/or GR (right) for grommet; add \$76 per grommet
- Specify LMP for laminate modesty panel; add \$276

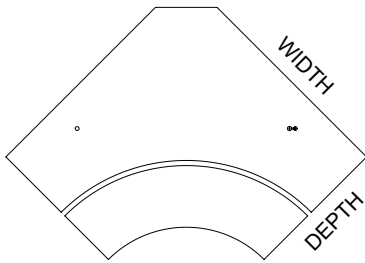
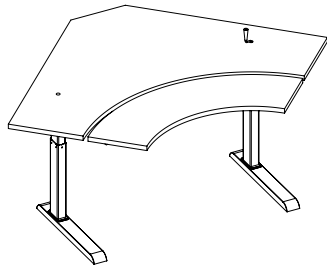

ACTUAL SIZE			LAMINATE	
WIDTH	DEPTH	WEIGHT/CUBE	PRICE M1	PRICE H1
46"	29"	105/60	3,081	3,350
46"	23"	105/60	3,081	3,350
40"	23"	100/60	3,012	3,275
40"	17"	100/60	3,012	3,275

Features & Specifications

No Charge Options

Optional Extra



ORDER CODE SAMPLE				
ITEM CODE	WIDTH	DEPTH	LAMINATE	OPTION
MTKCCVC	46	29	H1	LMP

- Leg provides 1" of leveling
- Laminate codes - M1: 1" LPL, H1: 1" HPL (top only)
- Default KBKW dual arm keyboard mechanism has a range of 9.5" above and 6.5" below worksurface with 15 degrees positive or negative tilt
- Top access crank handle/grommets are standard. Undermount option (UTS) does not remove top access holes
- Available in all standard laminates
- Available in standard metal paint finishes
- For sizes not listed, specify actual (not nominal) size in product code
- Straight front available; add option SF to product code
- Specify GL (left), GC (center) and/or GR (right) for grommet; add \$76 per grommet
- Specify LMP for laminate modesty panel; add \$276

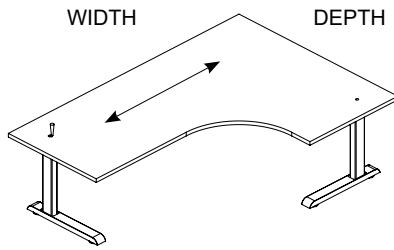

**EL**  
EXTENDED LEFT

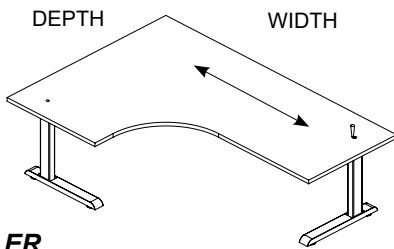

**ER**  
EXTENDED RIGHT

**23" DEEP RETURN ON BOTH SIDES**

ARROWS INDICATE GRAIN DIRECTION (IF APPLICABLE)

ACTUAL SIZE					LAMINATE	
WIDTH	DEPTH	RETURN	RADIUS	WT/CUBE	PRICE M1	PRICE H1
70"	58"	23"	18"	189/15.9	3,637	3,979
64"	58"	23"	18"	176/14.6	3,538	3,880
70"	52"	23"	18"	189/15.9	3,488	3,829
64"	52"	23"	18"	176/14.6	3,488	3,829
58"	52"	23"	18"	149/11.0	3,463	3,804
70"	46"	23"	18"	189/15.9	3,428	3,771
64"	46"	23"	18"	176/14.6	3,428	3,771
58"	46"	23"	18"	149/11.0	3,396	3,739
70"	40"	23"	18"	189/15.9	3,428	3,771
64"	40"	23"	18"	176/14.6	3,428	3,771
58"	40"	23"	18"	149/11.0	3,396	3,739



ORDER CODE SAMPLE							
ITEM CODE	RETURN	WIDTH	DEPTH	RETURN	LAMINATE	STYLE	OPTION
MECCK	23	70	46	23	M1	EL	GC

Features & Specifications

No Charge Options

Optional Extra

- Leg provides 1" of leveling
- Laminate codes - M1: 1" LPL, H1: 1" HPL (top only)
- Woodgrain runs horizontally on the longest side of the table
- Specify style - 'ER' - extended right, or 'EL' - extended left
- Top access crank handle/grommets are standard. Undermount option (UTS) does not remove top access holes
- Available in all standard laminates
- Available in standard metal paint finishes
- For sizes not listed, specify actual (not nominal) size in product code
- For straight front instead of standard curved, add code SF to options
- Specify GL (left), GC (center) and/or GR (right) for grommet; add \$76 per grommet
- Specify LMP for laminate modesty panel; add \$340
- For under surface handle operation add 'UTS' to product code; add \$236

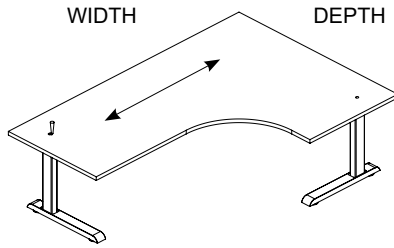

**EL**  
EXTENDED LEFT

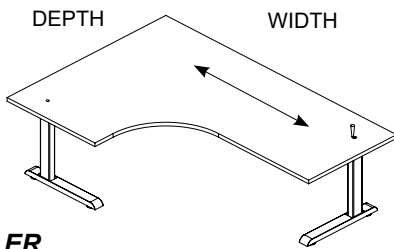

**ER**  
EXTENDED RIGHT

**29" DEEP RETURN ON BOTH SIDES**

ARROWS INDICATE GRAIN DIRECTION (IF APPLICABLE)

ACTUAL SIZE					LAMINATE	
WIDTH	DEPTH	RETURN	RADIUS	WT/CUBE	PRICE M1	PRICE H1
70"	58"	29"	18"	189/15.9	3,654	3,995
64"	58"	29"	18"	176/14.6	3,555	3,897
70"	52"	29"	18"	189/15.9	3,503	3,846
64"	52"	29"	18"	176/14.6	3,503	3,846
58"	52"	29"	18"	149/11.0	3,478	3,820
70"	46"	29"	18"	189/15.9	3,445	3,787
64"	46"	29"	18"	176/14.6	3,445	3,787
58"	46"	29"	18"	149/11.0	3,412	3,760
70"	40"	29"	18"	189/15.9	3,445	3,787
64"	40"	29"	18"	176/14.6	3,445	3,787
58"	40"	29"	18"	149/11.0	3,412	3,752



ORDER CODE SAMPLE							
ITEM CODE	RETURN	WIDTH	DEPTH	RETURN	LAMINATE	STYLE	OPTION
MECCK	29	70	46	29	M1	EL	GC

**Features & Specifications**

**No Charge Options**

**Optional Extra**

- Leg provides 1" of leveling
- Laminate codes - M1: 1" LPL, H1: 1" HPL (top only)
- Woodgrain runs horizontally on the longest side of the table
- Specify style - 'ER' - extended right, or 'EL' - extended left
- Top access crank handle/grommets are standard. Undermount option (UTS) does not remove top access holes
- Available in all standard laminates
- Available in standard metal paint finishes
- For sizes not listed, specify actual (not nominal) size in product code
- For straight front instead of standard curved, add code SF to options
- Specify GL (left), GC (center) and/or GR (right) for grommet; add \$76 per grommet
- Specify LMP for laminate modesty panel; add \$340
- For under surface handle operation add 'UTS' to product code; add \$236



# Viva

## Incremental Height Adjustable Tables

### Standard Features:

- LPL & HPL worksurfaces with overall height adjustability from 24" to 36" in one inch increments
- C Base two and three leg configurations
- Foot design matches all Viva line products
- No electrical power requirements

### Optional Features:

- Left, right and center grommets

### Basic Dimensions:

#### C-LEG

- Column: 2.0" x 4.0" [51mm x 102mm]
- Foot: 2.88" x 24" [73.2mm x 609.6mm]
- Foot height: 1.375" [34.9mm]

### Finishes:

#### BASE

- Powdercoat silver, black & white

#### WORKSURFACE

- 1" & 1.5" LPL & HPL in all standard BRC laminates

### General Product Overview:

Table bases are metal and have a durable scratch resistant, heat cured powder coat paint finish. Metal uprights are of 14 gauge tubing 2" thick by 4" wide. All table bases have a 1" x 3" horizontal modesty bar of 16 gauge steel attached to each leg to assure strength and stability. Incremental adjustment is made by removing the socket cap bolt on the back of each leg, setting height required and replacing bolt. Low profile foot is constructed of drawn steel, with waterfall front and back edges. The interior of the foot is double walled with 11 gauge steel supports. These feet have easy to access levelers for ease of installation and balancing.

ANSI Bifma and CGSB (Canadian General Standards Board) tested and qualified. This ensures that BRC products adhere to the highest standards of quality and durability in North America.

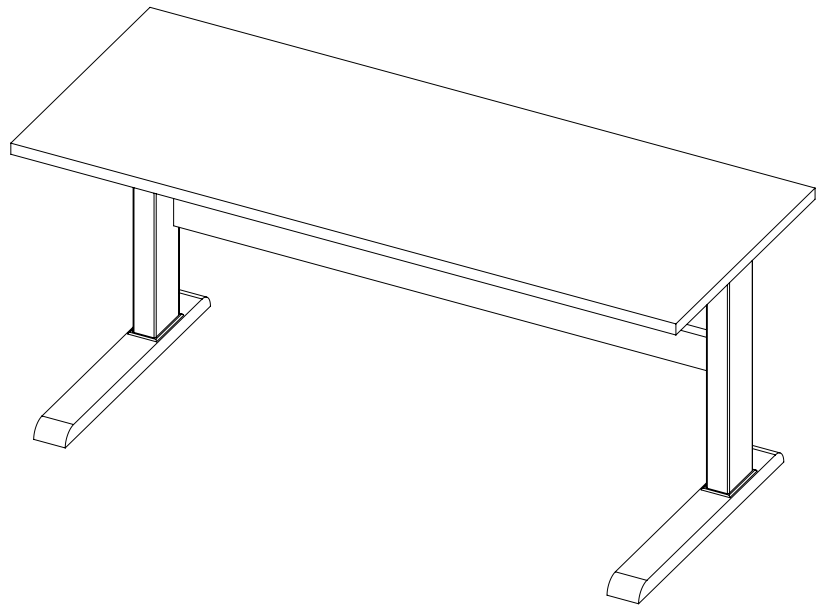

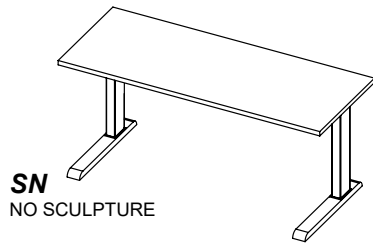

**SN**  
NO SCULPTURE

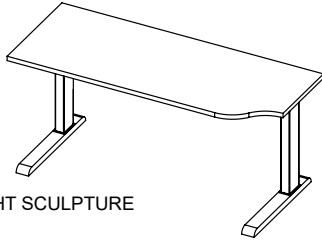

**SR**  
RIGHT SCULPTURE

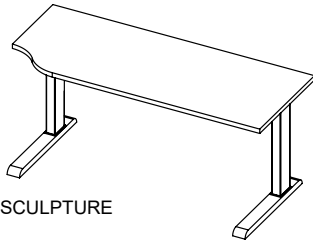

**SL**  
LEFT SCULPTURE

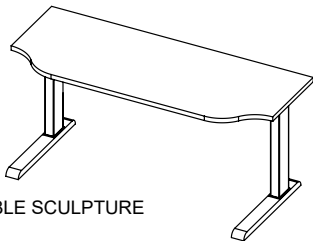

**SD**  
DOUBLE SCULPTURE

ACTUAL SIZE			LAMINATE	
WIDTH	DEPTH	WEIGHT/CUBE	PRICE M1	PRICE H1
94"	35"	140/75	2,293	2,541
82"	35"	120/72	1,944	2,183
82"	29"	120/72	1,835	2,072
76"	29"	110/72	1,713	1,913
70"	29"	110/72	1,563	1,731
64"	29"	110/60	1,520	1,685
58"	29"	110/60	1,463	1,622
46"	29"	105/48	1,379	1,492
40"	29"	95/48	1,237	1,348
34"	29"	85/36	1,206	1,310
28"	29"	75/30	1,166	1,274
82"	23"	120/76	1,835	2,072
76"	23"	115/72	1,713	1,913
70"	23"	115/72	1,487	1,640
64"	23"	105/60	1,410	1,561
58"	23"	100/48	1,340	1,463
46"	23"	90/48	1,297	1,401
40"	23"	80/36	1,152	1,257
34"	23"	70/30	1,120	1,219
28"	23"	70/30	1,092	1,184
22"	23"	70/30	1,092	1,184



ORDER CODE SAMPLE					
ITEM CODE	WIDTH	DEPTH	LAMINATE	SCULPTURE	OPTION
MTCI	70	23	H1	SN	LMP BF

Features & Specifications

- Leg provides 1" of leveling
- Laminate codes - M1: 1" LPL, H1: 1" HPL (top only)
- Specify sculpture - 'SN' - none, 'SR' - right, 'SL' - left, or 'SD' - double

No Charge Options

- Available in all standard laminates
- Available in standard metal paint finishes
- For sizes not listed, specify actual (not nominal) size in product code

Optional Extra

- Specify GL (left), GC (center) and/or GR (right) for grommet; add \$76 per grommet
- Specify LMP for laminate modesty panel; add \$276
- 6" Bow fronts for tables 58" and larger available; add BF to code and \$213

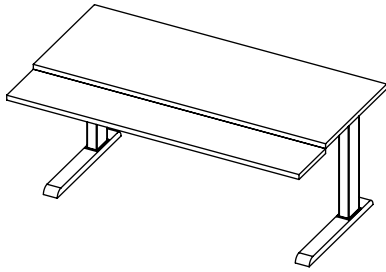

DUAL ARM KEYBOARD

ACTUAL SIZE			LAMINATE	
WIDTH	DEPTH	WEIGHT/CUBE	PRICE M1	PRICE H1
70"	29"	135/8	2,792	3,045
58"	29"	125/7	2,498	2,901
46"	29"	115/6	2,353	2,582
40"	29"	100/6	2,245	2,466



ORDER CODE SAMPLE			
ITEM CODE	WIDTH	LAMINATE	OPTION
MTCI	58	H1	LMP

Features & Specifications

- Leg provides 1" of leveling
- Laminate codes - M1: 1" LPL, H1: 1" HPL (top only)
- Default KBKW-B dual arm keyboard mechanism has a range of 9.5" above and 6.5" below worksurface with 15 degrees positive or negative tilt

No Charge Options

- Available in all standard laminates
- Available in standard metal paint finishes
- For sizes not listed, specify actual (not nominal) size in product code

Optional Extra

- Specify *GL* (left), *GC* (center) and/or *GR* (right) for grommet; add \$76 per grommet
- Specify *LMP* for laminate modesty panel; add \$276
- Sliding keyboard with 5" of adjustment; add *KW(FOC)* to code and add \$418

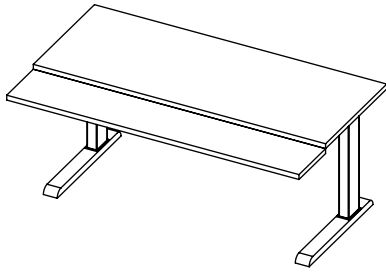

SINGLE ARM KEYBOARD

ACTUAL SIZE			LAMINATE	
WIDTH	DEPTH	WEIGHT/CUBE	PRICE M1	PRICE H1
34"	29"	95/50	1,846	2,031
28"	29"	89/40	1,806	1,989



ORDER CODE SAMPLE			
ITEM CODE	WIDTH	LAMINATE	OPTION
MTCISA	34	H1	LMP

Features & Specifications

- Leg provides 1" of leveling
- Laminate codes - M1: 1" LPL, H1: 1" HPL (top only)
- Default KBSS single arm keyboard mechanism has a range of 6" above and 6" below worksurface with 15 degrees positive or negative tilt

No Charge Options

- Available in all standard laminates
- Available in standard metal paint finishes
- For sizes not listed, specify actual (not nominal) size in product code

Optional Extra

- Specify *GL* (left), *GC* (center) and/or *GR* (right) for grommet; add \$76 per grommet
- Specify *LMP* for laminate modesty panel; add \$276

# Viva

## Fixed Height Tables

### Standard Features:

- Fixed height base at 29" height overall with 1" worksurface (29.5" with 1.5" worksurface)
- LPL & HPL worksurfaces
- C Base with two and three leg configurations
- Foot provides 1" of levelling

### Optional Features:

- Available with casters
- Left, right and center grommets

### Basic Dimensions:

#### C-LEG

- Column: 2.0" x 4.0" [51mm x 102mm]
- Foot: 2.88" x 24" [73.2mm x 609.6mm]
- Foot height: 1.375" [34.9mm]

### Finishes:

#### BASE

- Powdercoat silver, black & white

#### WORKSURFACE

- 1" & 1.5" LPL & HPL in all standard BRC laminates

### General Product Overview:

Table bases are metal and have a durable scratch resistant, heat cured powder coat paint finish. Table surfaces are supported by a 3/4" x 1 1/2" steel frame designed for strength and ease of connections. Metal uprights are of 14 gauge tubing 2" thick by 4" wide. On all tables, inserts are of 14 gauge tubing and incorporate Teflon-like slides for smooth operation and low maintenance. All table bases have a 1" x 3" horizontal modesty bar of 16 gauge steel attached to each leg to assure strength and stability throughout the entire range of motion. Low profile foot is constructed of drawn steel, with waterfall front and back edges. The interior of the foot is double walled with 11 gauge steel supports. These feet have easy to access levelers for ease of installation and balancing.

ANSI Bifma and CGSB (Canadian General Standards Board) tested and qualified. This ensures that BRC products adhere to the highest standards of quality and durability in North America.

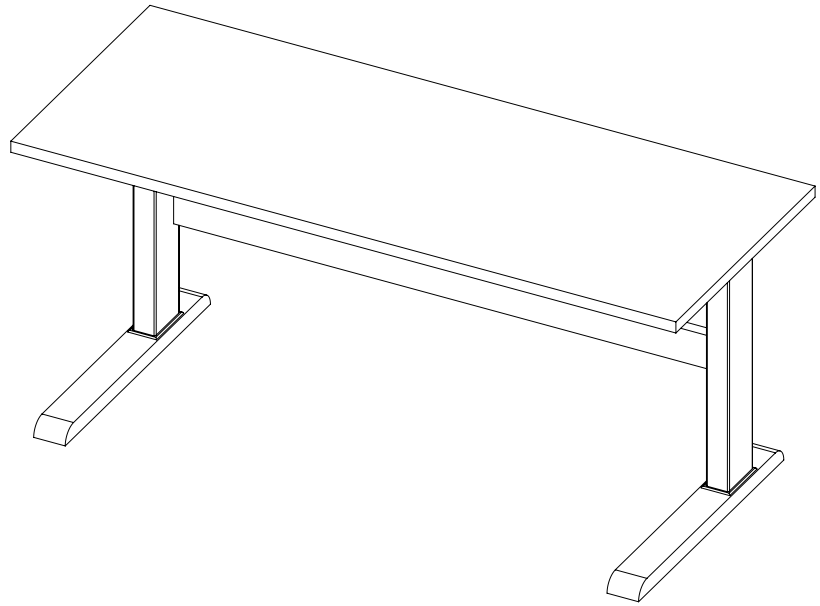

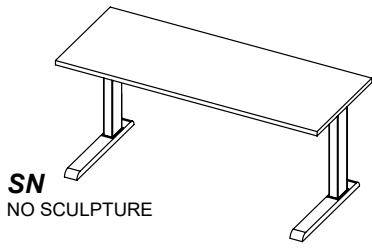

**SN**  
NO SCULPTURE

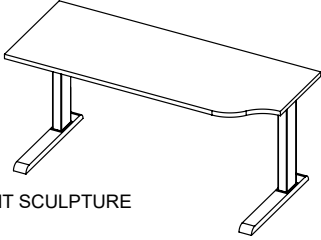

**SR**  
RIGHT SCULPTURE

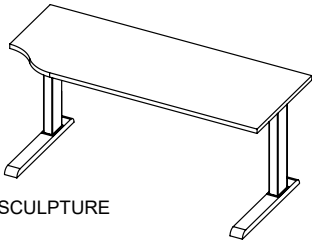

**SL**  
LEFT SCULPTURE

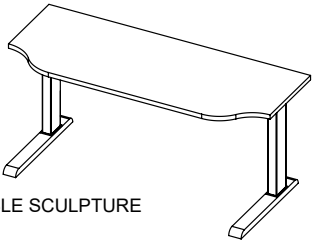

**SD**  
DOUBLE SCULPTURE

**Features & Specifications**

**No Charge Options**

**Optional Extra**

ACTUAL SIZE			LAMINATE	
WIDTH	DEPTH	WEIGHT/CUBE	PRICE M1	PRICE H1
94"	35"	140/75	1,989	2,389
82"	29"	120/72	1,683	1,921
76"	29"	110/72	1,563	1,760
70"	29"	110/72	1,411	1,577
64"	29"	110/60	1,365	1,517
58"	29"	110/60	1,310	1,470
52"	29"	105/48	1,310	1,470
46"	29"	105/48	1,226	1,340
40"	29"	95/48	1,083	1,196
34"	29"	85/36	1,054	1,159
28"	29"	75/30	1,014	1,120
82"	23"	120/76	1,586	1,896
76"	23"	115/72	1,586	1,744
70"	23"	115/72	1,335	1,487
64"	23"	105/60	1,244	1,372
58"	23"	100/48	1,189	1,310
52"	23"	90/48	1,189	1,310
46"	23"	90/48	1,144	1,249
40"	23"	80/36	1,001	1,106
34"	23"	70/30	968	1,067
28"	23"	70/30	937	1,029
22"	23"	70/30	937	1,029



ORDER CODE SAMPLE					
ITEM CODE	WIDTH	DEPTH	LAMINATE	SCULPTURE	OPTION
MWCF	70	23	M1	SD	LMP BF

- Leg provides 1" of leveling
- Laminate codes - M1: 1" LPL, H1: 1" HPL (top only)
- Specify sculpture - 'SN' - none, 'SR' - right, 'SL' - left, or 'SD' - double

- Available in all standard laminates
- Available in standard metal paint finishes
- For sizes not listed, specify actual (not nominal) size in product code

- Specify *GL* (left), *GC* (center) and/or *GR* (right) for grommet; add \$76 per grommet
- Specify *LMP* for laminate modesty panel; add \$276
- 6" Bow fronts for tables 58" and larger available; add *BF* to code and \$213



**A1**  
STRAIGHT FRONT  
CURVE BACK



**A2**  
CURVE FRONT  
CURVE BACK



**B1**  
STRAIGHT FRONT  
STRAIGHT BACK

ACTUAL SIZE				LAMINATE	
WIDTH	DEPTH	USER WIDTH	WEIGHT/ CUBE	PRICE M1	PRICE H1
46"	29"	25"	105/60	1,683	1,737
40"	29"	17"	105/60	1,531	1,675
46"	23"	34"	105/60	1,683	1,737
40"	23"	25"	100/60	1,531	1,675
34"	23"	17"	90/54	1,038	1,159
28"	23"	9"	90/54	1,038	1,159



ORDER CODE SAMPLE					
ITEM CODE	WIDTH	DEPTH	LAMINATE	STYLE	OPTION
MTKCF	46	29	H1	A1	LMP

Features & Specifications

- Leg provides 1" of leveling
- Laminate codes - M1: 1" LPL, H1: 1" HPL (top only)
- Specify worksurface style: 'A1', 'A2' or 'B1'

No Charge Options

- Available in all standard laminates
- Available in standard metal paint finishes
- For sizes not listed, specify actual (not nominal) size in product code

Optional Extra

- Specify *GL* (left), *GC* (center) and/or *GR* (right) for grommet; add \$76 per grommet
- Specify *LMP* for laminate modesty panel; add \$276

# Power Spine

## Power & Data Feed to Workstations

### Standard Features:

- Provides power, data and USB support
- Multi unit linking capability
- Ceiling feed option
- Wire management and screen options

### Finishes:

#### Spine & Legs

- Powdercoat available in standard finishes

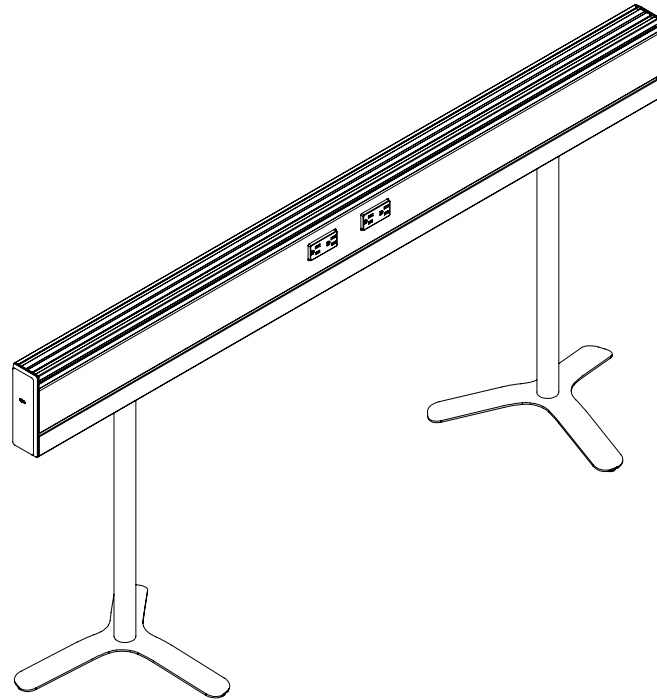

### General Product Overview:

The Power Spine provides power, data and USB support to workstations or areas that require more extensive support than a power strip will accommodate. Available in up to 6 circuits with shared or independent wiring options, multiple units can be linked to provide 15 or 20 amp receptacles and 2.1 amp USB power modules.

## General Product Overview:

The Power Spine provides power, data and USB support to workstations or areas that require more extensive support than a power strip will accommodate. Available in up to 6 circuits with shared or independent wiring options, multiple units can be linked to provide 15 or 20 amp receptacles and 2.1 amp USB power modules.

## Specifying:

The Power Spine is sold with a single leg to allow for daisy chaining without having extra parts after installation. Use the following information for guidance on product and part quantities for inline applications.

### Single Service Spine

- 1 x MJSSE Spine
- 1 x MJSFN Support Leg
- 1 x MJCCN End Cap

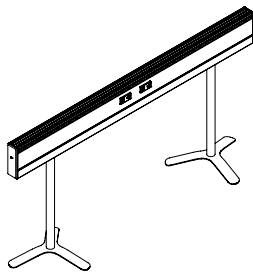

### Double Inline Service Spine

- 2 x MJSSE Spine
- 1 x MJSFN Support Leg
- 1 x MJCCN End Cap

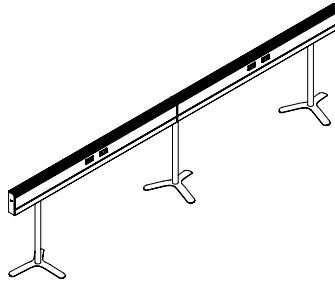

### Three Inline Service Spine

- 3 x MJSSE Spine
- 1 x MJSFN Support Leg
- 1 x MJCCN End Cap

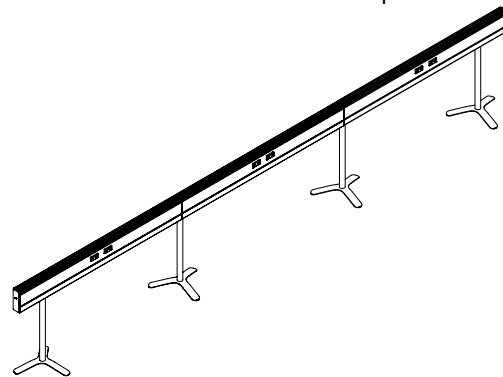

## Support Leg Adjustability:

Single Service Spine leg placement

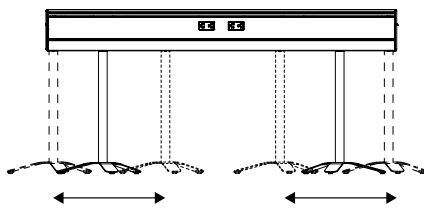

Support leg can be mounted offset from end of spine as required

Multiple Service Spine leg placement

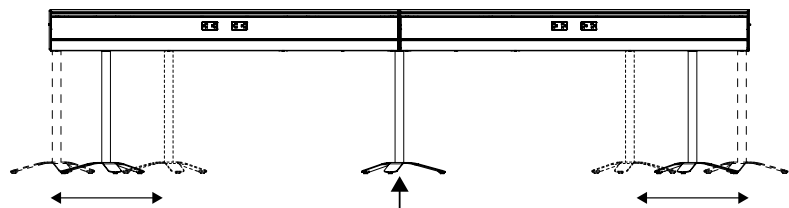

Center support leg is fixed midway in multiple inline configurations

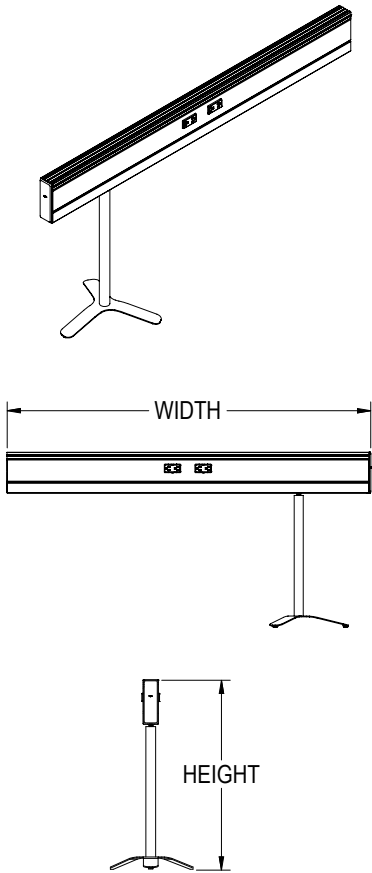

ACTUAL SIZE		POWER	
WIDTH	HEIGHT	SINGLE SIDED 1S	DOUBLE SIDED 2S
24"	29"	855	984
30"	29"	905	1,041
36"	29"	955	1,099
42"	29"	1,005	1,156
48"	29"	1,055	1,214
54"	29"	1,125	1,294
60"	29"	1,195	1,375
66"	29"	1,265	1,455
72"	29"	1,335	1,536



ORDER CODE SAMPLE				
ITEM CODE	WIDTH	HEIGHT	POWER	OPTION
MJSSE	46	29	1S	1D

Features & Specifications

No Charge Options

Optional Extra

- Includes one support leg & end cover cap
- Main power body is 2.5" deep by 7" high
- Widths 48" - 60" contain two duplex outlets per side
- Widths 66" - 72" contain four duplex outlets per side
- Available in standard metal paint finishes
- Specify single sided '1S' or double sided "2S' power configuration
- Two knock outs provided for data jacks per side are available. Specify option code single sided '1D' or double sided '2D' and add \$175 per side

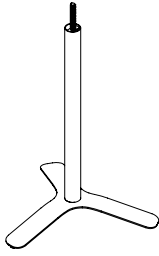

<b>MJSFN - Support Leg</b>	
FEATURES & SPECIFICATIONS	PRICE
<ul style="list-style-type: none"> <li>• Includes support leg, mounting bracket and hardware</li> <li>• Available in all standard metal finishes</li> </ul>	780

<b>MJCCN - End Cap</b>	
FEATURES & SPECIFICATIONS	PRICE
<ul style="list-style-type: none"> <li>• Includes end cap and mounting hardware</li> <li>• Available in all standard metal finishes</li> </ul>	88



<b>ORDER CODE SAMPLE</b>
ITEM CODE
MJCCN

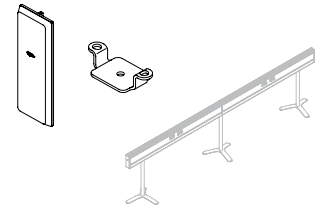

<b>MJ2WN - Inline Connector Kit</b>	
FEATURES & SPECIFICATIONS	PRICE
<ul style="list-style-type: none"> <li>Includes end cap, leg bridge and joining hardware.</li> <li>Available in all standard metal finishes</li> </ul>	868

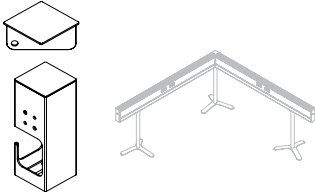

<b>MJ9WN - 2 Way 90 Degree Connector Kit</b>	
FEATURES & SPECIFICATIONS	PRICE
<ul style="list-style-type: none"> <li>Includes top cap, mounting bracket and joining hardware.</li> <li>Available in all standard metal finishes</li> </ul>	1140

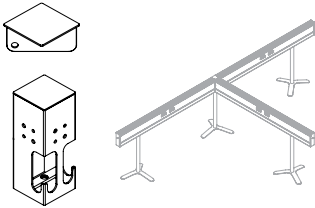

<b>MJ3WN - 3 Way 90 Degree Connector Kit</b>	
FEATURES & SPECIFICATIONS	PRICE
<ul style="list-style-type: none"> <li>Includes top cap, mounting bracket and joining hardware.</li> <li>Available in all standard metal finishes</li> </ul>	1140

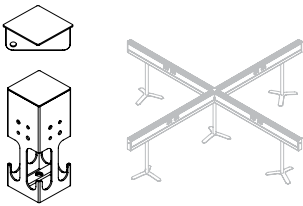

<b>MJ4WN - 4 Way 90 Degree Connector Kit</b>	
FEATURES & SPECIFICATIONS	PRICE
<ul style="list-style-type: none"> <li>Includes top cap, mounting bracket and joining hardware.</li> <li>Available in all standard metal finishes</li> </ul>	1140



<b>MJ2TN - 2 Way 120 Degree Connector Kit</b>	
FEATURES & SPECIFICATIONS	PRICE
<ul style="list-style-type: none"> <li>Includes top cap, mounting bracket and joining hardware.</li> <li>Available in all standard metal finishes</li> </ul>	1140

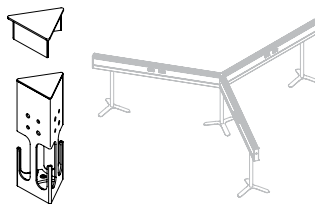

<b>MJ3TN - 3 Way 120 Degree Connector Kit</b>	
FEATURES & SPECIFICATIONS	PRICE
<ul style="list-style-type: none"> <li>Includes top cap, mounting bracket and joining hardware.</li> <li>Available in all standard metal finishes</li> </ul>	1140

▽

ORDER CODE SAMPLE
ITEM CODE
MJ2WN

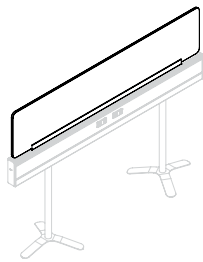
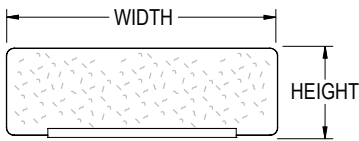
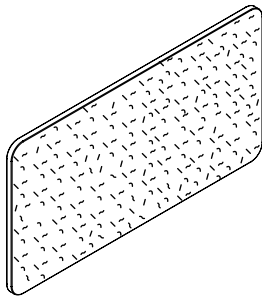

**Features & Specifications**

**No Charge Options**

**ACTUAL SIZE**

WIDTH	HEIGHT	PRICE
24"	12"	460
30"	12"	494
36"	12"	554
42"	12"	708
48"	12"	714
54"	12"	781
60"	12"	817
66"	12"	841
72"	12"	864
24"	18"	758
30"	18"	801
36"	18"	887
42"	18"	890
48"	18"	893
54"	18"	1,142
60"	18"	1,144
66"	18"	1,609
72"	18"	1,616
24"	24"	763
30"	24"	871
36"	24"	878
42"	24"	886
48"	24"	892
54"	24"	1,244
60"	24"	1,251
66"	24"	1,749
72"	24"	1,756
24"	26"	763
30"	26"	871
36"	26"	878
42"	26"	886
48"	26"	892
54"	26"	1,244
60"	26"	1,251
66"	26"	1,749
72"	26"	1,756



**ORDER CODE SAMPLE**

ITEM CODE	WIDTH	HEIGHT
MJFTN	W60	H40

- Includes power service spine attaching bracket and hardware
- Felt is 0.5" thick

- Available in standard felt colours

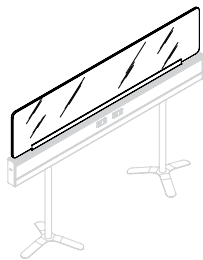
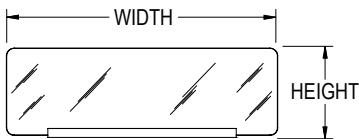
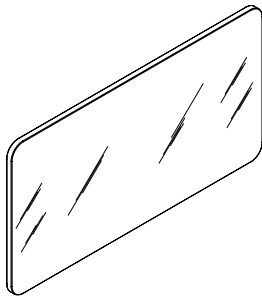

Features & Specifications

No Charge Options

**ACTUAL SIZE**

WIDTH	HEIGHT	PRICE
24"	12"	649
30"	12"	688
36"	12"	750
42"	12"	805
48"	12"	811
54"	12"	876
60"	12"	882
66"	12"	942
72"	12"	960
24"	18"	691
30"	18"	745
36"	18"	836
42"	18"	891
48"	18"	895
54"	18"	960
60"	18"	975
66"	18"	1,024
72"	18"	1,042
24"	24"	746
30"	24"	805
36"	24"	903
42"	24"	962
48"	24"	967
54"	24"	1,037
60"	24"	1,053
66"	24"	1,106
72"	24"	1,125
24"	26"	746
30"	26"	805
36"	26"	903
42"	26"	962
48"	26"	967
54"	26"	1,037
60"	26"	1,053
66"	26"	1,106
72"	26"	1,125



**ORDER CODE SAMPLE**

ITEM CODE	WIDTH	HEIGHT
MJATN	W60	H40

- Includes power service spine attaching bracket and hardware
- Frosted acrylic is 0.25" thick

- Available in standard felt colours



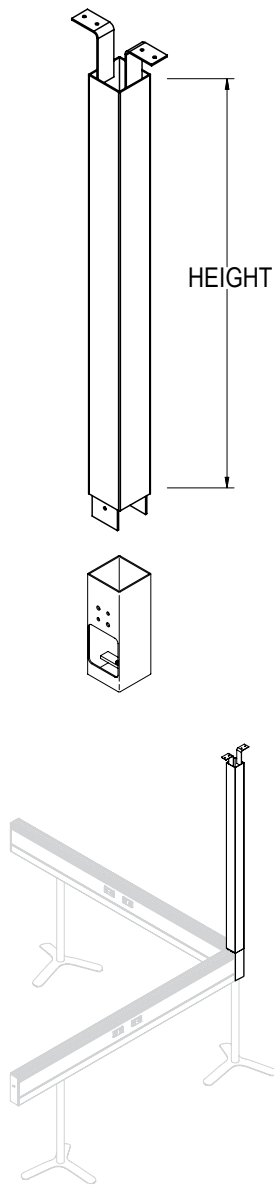

Features & Specifications

No Charge Options

**ACTUAL SIZE**

HEIGHT	PRICE
72"	725
84"	738
96"	750
108"	770
120"	798
132"	825



**ORDER CODE SAMPLE**

ITEM CODE	HEIGHT
MJCFE	H120

- Includes extruded ceiling feed, attaching brackets and hardware
- Aluminum extrusion can be cut to height on site as required
- Feed is 2.5" square

- Available in standard metal finishes

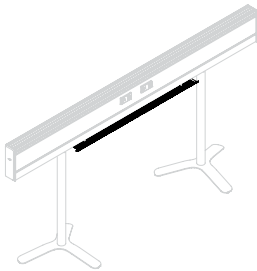
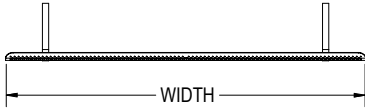
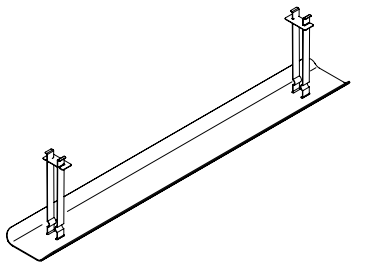

**ACTUAL SIZE**

WIDTH	PRICE
12"	410
18"	430
24"	450
30"	470
36"	490
42"	510
48"	530
54"	550
60"	580



**ORDER CODE SAMPLE**

ITEM CODE	WIDTH
MJWME	W60

**Features & Specifications**

- Includes wire management basket and mounting hardware
- Basket mounts between supporting legs

**No Charge Options**

- Available in standard metal finishes

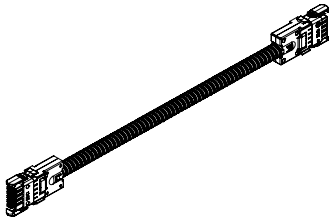
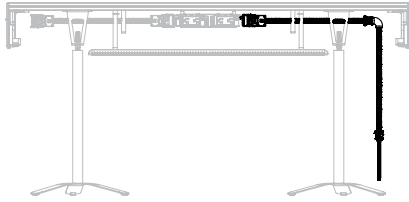
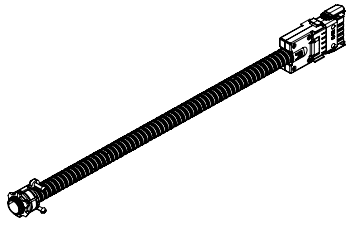

**MJFDE - Infeed Cable**

FEATURES & SPECIFICATIONS	PRICE
<ul style="list-style-type: none"> <li>• For connecting hardwired power into the service spine</li> <li>• 14 ft length</li> </ul>	492

**MJJME - Jumper Cable**

FEATURES & SPECIFICATIONS	PRICE
<ul style="list-style-type: none"> <li>• For use between power service spines if required</li> </ul>	315



ORDER CODE SAMPLE
ITEM CODE
MJCCN

# SoHo

## Executive Electric Height Adjustability with Storage

### Standard Features:

- Raised dual one box, one file (BF) locking pedestals
- Anti collision piezoelectric sensor stops movement when obstruction is encountered
- Dual motors use 0.1W standby and are whisper quiet at 55db when in use. 125" Cord length
- LPL & HPL worksurfaces
- Floating half modesty panel
- Height range from 27" to 50"
- 300lb lift capacity with 1.5" per second travel
- Premium handset (DPG1C) included
- Bluetooth with Desk Control App

### Optional Features:

- Left, right and center grommets
- Rechargeable Battery

### Basic Dimensions:

#### BOX FILE PEDESTAL

- 4" high post feet with 1" leveling
- 15.5" wide x 23.375" high x variable depths

### Finishes:

#### COLUMN & POST FEET

- Powdercoat silver, black & white

#### WORKSURFACE

- 1" LPL & HPL in all standard BRC laminates
- 1.25" HPL knife edge

### General Product Overview:

Table base frames are metal and have a durable scratch resistant, heat cured powder coat paint finish. Table surfaces are supported by a 3/4" x 1 1/2" steel frame designed for strength and ease of connections. Metal uprights are of 14 gauge tubing 2" thick by 4" wide. On all tables, inserts are of 14 gauge tubing and incorporate Teflon-like slides for smooth operation and low maintenance. One box, one file pedestals are locking and raised on 4" post feet with 1" leveling capability. All standard BRC laminates, handles and metal colours are available. Worksurface width and depth are overall dimensions; pedestals do not protrude past this.

ANSI Bifma and CGSB (Canadian General Standards Board) tested and qualified. This ensures that BRC products adhere to the highest standards of quality and durability in North America.

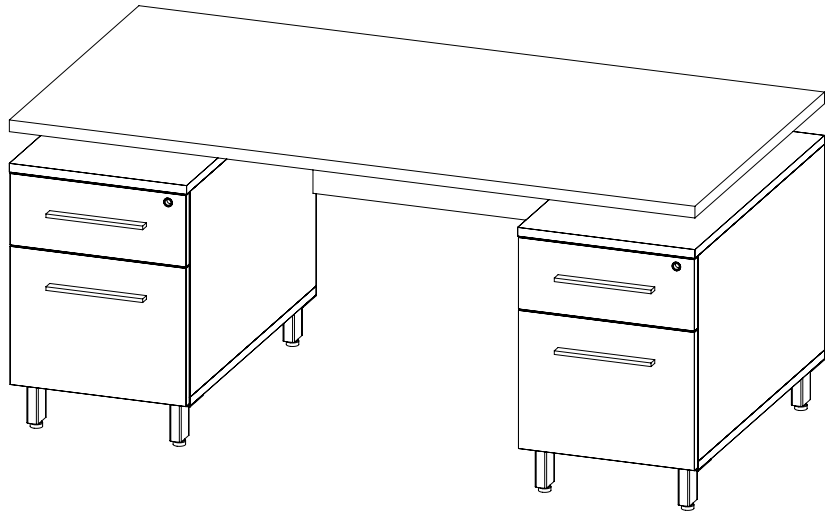

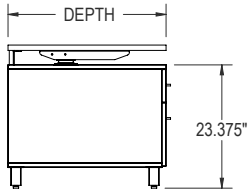
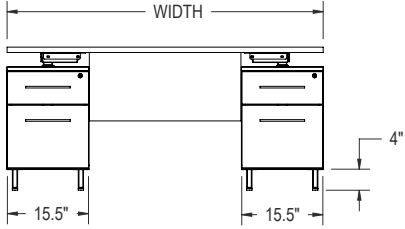
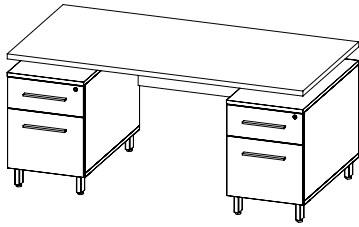

ACTUAL SIZE		LAMINATE		
WIDTH	DEPTH	PRICE M1	PRICE H1	PRICE K1
84"	36"	5,162	5,655	6,899
78"	36"	5,045	5,495	6,675
72"	36"	4,899	5,314	6,431
66"	36"	4,858	5,252	6,310
60"	36"	4,807	5,205	6,200
84"	30"	4,898	5,380	6,559
78"	30"	4,782	5,219	6,339
72"	30"	4,637	5,037	6,093
66"	30"	4,595	4,976	5,970
60"	30"	4,544	4,930	5,860

Features & Specifications

No Charge Options

Optional Extra



ORDER CODE SAMPLE				
ITEM CODE	WIDTH	DEPTH	LAMINATE	OPTION
SOHO	72	30	H1	HP

- Leg provides 1" of leveling
- Laminate codes - M1: 1" LPL, H1: 1" HPL, K1: 1" HPL knife edge (top only)
- Includes floating laminate modesty panel
- Dual box file pedestals are keyed alike by default

- Available in all standard laminates
- Frame available in standard metal paint finishes

- Specify *GL* (left), *GC* (center) and/or *GR* (right) for grommet; add \$76 per grommet
- For HPL drawer fronts add option code *HP*; add \$326

# NoLita

## Dynamic Electric Height Adjustability

### Standard Features:

- LPL & HPL Worksurfaces available with overall height adjustability from 25.75" to 46.25"
- Anti collision sensor stops movement when obstruction is encountered
- 0.75" Gap between worksurfaces to allow for pinch clearance
- Dual motors use 0.1W standby and are whisper quiet at 55db when in use
- LPL, HPL and knife edge worksurfaces
- Concealed frosted acrylic modesty panel
- 250lb lift capacity
- Premium handset (DPG1C) included
- Bluetooth with Desk Control App

### Optional Features:

- Rechargeable Battery for cordless operation
- Left, right and center grommets

### Finishes:

#### LIFTING COLUMN, TRIM & FRAME

- Powdercoat silver, black or white

#### WORKSURFACE & FASCIA COVER BASE

- 1" LPL & HPL in all standard BRC laminates
- 1.25" HPL knife edge on three sides; flat edge on back side

### Trim:

- Optional knife edge trim does not cover entire perimeter; see graphic below for details

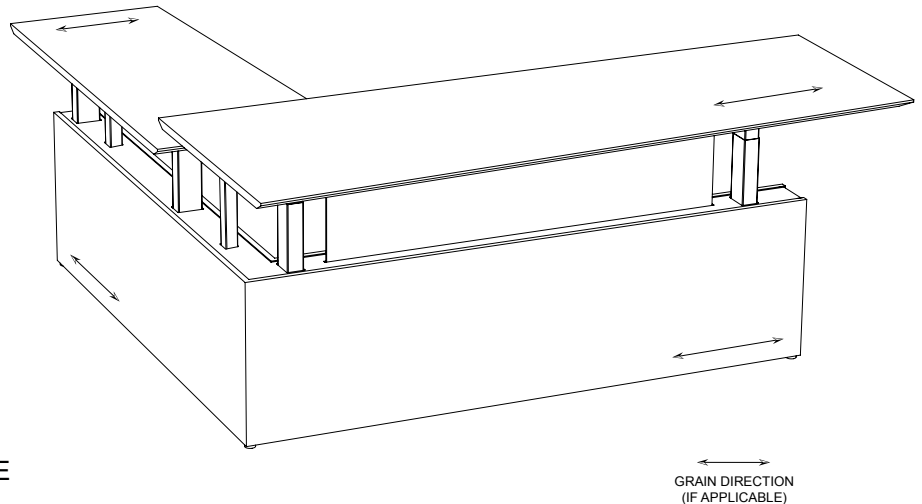
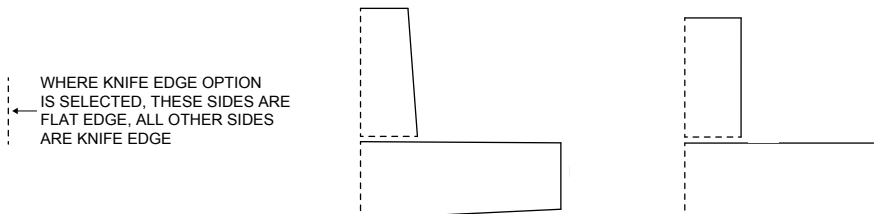

### General Product Overview:

Lower cover fascia is made from LP laminate available in all BRC standard finishes. Lower cover fascia end and top trim caps are metal and painted to match the lifting columns. Table base internal frames are metal and have a durable scratch resistant, heat cured powder coat paint finish. Table surfaces are supported by a 1 1/4" tubular steel frame designed for strength and ease of connections. One or both surfaces are available to be height adjustable. The concealed modesty panel is available as standard on one surface only. Due to the nature of this product, extended lead times may apply. Please contact orders@brc.group for details before ordering.

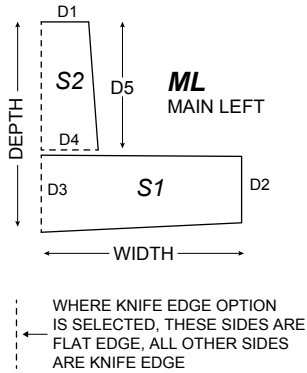
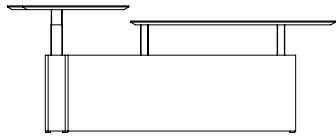
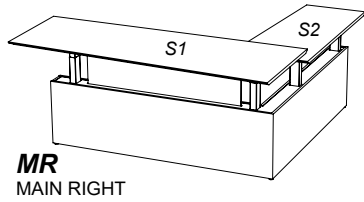
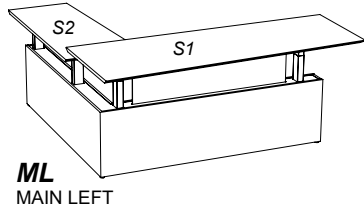

**Features & Specifications**

**No Charge Options**

**Optional Extra**

OVERALL SIZE		LAMINATE		
WIDTH	DEPTH	PRICE M1	PRICE H1	PRICE K1
72"	81"	14,447	15,010	16,441
66"	81"	14,255	14,776	16,201
63"	81"	14,230	14,751	16,177
72"	78"	14,205	14,726	16,151
66"	78"	14,163	14,685	16,125
63"	78"	14,137	14,660	16,093
72"	72"	14,048	14,569	16,061
66"	72"	13,784	14,247	15,786
63"	72"	13,747	14,079	15,408

**Product Description:**

- Dual surface means both worksurfaces are independently height adjustable.
- Two handset controllers are provided for the dual surface NoLita. Note, one controller cannot be used to control both surfaces at the same time.
- Worksurface is tapered as shown.

DIMENSION CHART						
WIDTH	DEPTH	D1	D2	D3	D4	D5
72"	81"	26"	28"	32"	30"	48.25"
66"	81"	26"	28"	32"	30"	48.25"
63"	81"	26"	28"	32"	30"	48.25"
72"	78"	26"	28"	32"	30"	45.25"
66"	78"	26"	28"	32"	30"	45.25"
63"	78"	26"	28"	32"	30"	45.25"
72"	72"	26"	28"	32"	30"	39.25"
66"	72"	26"	28"	32"	30"	39.25"
63"	72"	26"	28"	32"	30"	39.25"



ORDER CODE SAMPLE						
ITEM CODE	WIDTH	DEPTH	LAMINATE	HAND	GROMMET	BASE
NLTADT	72	78	K1	ML	S1GC	HPB

- Base provides 1" of leveling
- Laminate codes - M1: 1" LPL, H1: 1" HPL, K1: 1" HPL knife edge (top only)
- Both surfaces provide separate height adjustability
- Includes frosted acrylic concealed modesty panel on right hand (S1) worksurface only
- Controller placement can be determined on site

- Available in all standard laminates
- Frame available in standard metal paint finishes

- For grommets, specify surface first (S1 or S2) and then GL (left), GC (center) and/or GR (right); add \$76 per grommet
- Base cover available in HPL (LPL by default). Add \$1,811 & code HPB

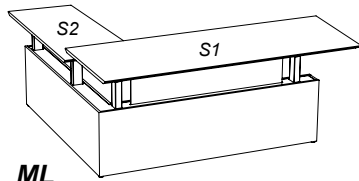

**ML**  
MAIN LEFT

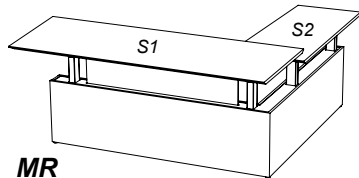

**MR**  
MAIN RIGHT

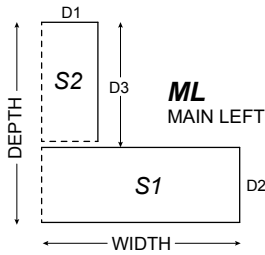
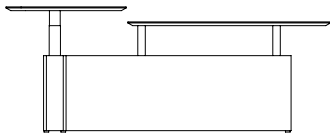

WHERE KNIFE EDGE OPTION IS SELECTED, THESE SIDES ARE FLAT EDGE, ALL OTHER SIDES ARE KNIFE EDGE

**Features & Specifications**

**No Charge Options**

**Optional Extra**

OVERALL SIZE		LAMINATE		
WIDTH	DEPTH	PRICE M1	PRICE H1	PRICE K1
72"	81"	14,447	15,010	16,441
66"	81"	14,255	14,776	16,201
63"	81"	14,230	14,751	16,177
72"	78"	14,205	14,726	16,151
66"	78"	14,163	14,685	16,125
63"	78"	14,137	14,660	16,093
72"	72"	14,048	14,569	16,061
66"	72"	13,784	14,247	15,786
63"	72"	13,747	14,079	15,408

**Product Description:**

- Dual surface means both worksurfaces are independantly height adjustable.
- Two handset controllers are provided for the dual surface NoLita. Note, one controller cannot be used to control both surfaces at the same time.
- Worksurface is rectangular as shown.

DIMENSION CHART				
WIDTH	DEPTH	D1	D2	D3
72"	81"	28"	32"	48.5"
66"	81"	28"	32"	48.5"
63"	81"	28"	32"	48.5"
72"	78"	28"	32"	45.5"
66"	78"	28"	32"	45.5"
63"	78"	28"	32"	45.5"
72"	72"	28"	32"	39.5"
66"	72"	28"	32"	39.5"
63"	72"	28"	32"	39.5"



ORDER CODE SAMPLE						
ITEM CODE	WIDTH	DEPTH	LAMINATE	HAND	GROMMET	BASE
NLTADR	72	78	K1	ML	S1GC	HPB

- Base provides 1" of leveling
- Laminate codes - M1: 1" LPL, H1: 1" HPL, K1: 1" HPL knife edge (top only)
- Both surfaces provide separate height adjustability
- Includes frosted acrylic concealed modesty panel on right hand (S1) worksurface only
- Controller placement can be determined on site

- Available in all standard laminates
- Frame available in standard metal paint finishes

- For grommets, specify surface first (S1 or S2) and then GL (left), GC (center) and/or GR (right); add \$76 per grommet
- Base cover available in HPL (LPL by default). Add \$1,811 & code HPB

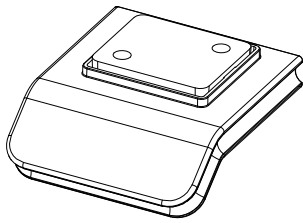

**BASIC CONTROLLER**

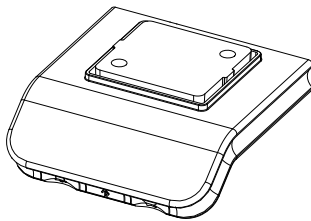

**CONTROLLER WITH BLUETOOTH**

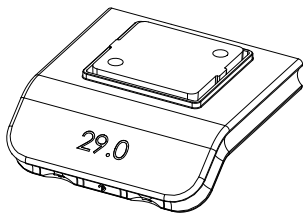

**CONTROLLER WITH BLUETOOTH AND DIGITAL DISPLAY**

<b>DPG1K</b>	
FEATURES & SPECIFICATIONS	PRICE
<ul style="list-style-type: none"> <li>• Standard on all viva electric height adjustable tables (not available for Mesa)</li> <li>• Lift up to raise, push down to lower</li> </ul>	75

<b>DPG1B</b>	
FEATURES & SPECIFICATIONS	PRICE
<ul style="list-style-type: none"> <li>• Lift up to raise, push down to lower</li> <li>• 2 Memory positions</li> <li>• LED light strip reminder</li> <li>• Bluetooth via desk control app</li> <li>• Optional on all Viva electric height adjustable tables (not available for Mesa)</li> <li>• Replaces standard controller DPG1K</li> </ul>	184

<b>DPG1C</b>	
FEATURES & SPECIFICATIONS	PRICE
<ul style="list-style-type: none"> <li>• Lift up to raise, push down to lower</li> <li>• 4 Memory positions</li> <li>• LED light strip reminder</li> <li>• Digital height display in metric or imperial units</li> <li>• Bluetooth via desk control app</li> <li>• Standard on all SoHo and NoLita electric height adjustable tables, optional on all Viva tables (not available for Mesa)</li> <li>• Replaces standard controller DPG1K</li> </ul>	280



<b>ORDER CODE SAMPLE</b>	
ITEM CODE	CONTROLLER
MWEE7123M1NS	DPG1B

**Product Notes**

All Viva electric tables ship standard with controller DPG1K. SoHo and NoLita electric tables ship standard with DPG1C. To specify an optional controller, add the model number (eg: DPG1B) to the end of the Viva product code.

These controllers are not available for Mesa electric tables.

Contact BRC for a link to download the desk control app for iOS and Android.

# Battery Option

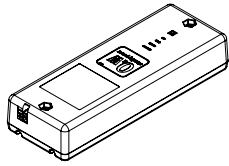

**RECHARGEABLE BATTERY  
FOR VIVA, SOHO & NOLITA**

**BA001**

FEATURES & SPECIFICATIONS	PRICE
<ul style="list-style-type: none"> <li>• For use with Viva, SoHo and NoLita product only; not for use with Mesa</li> <li>• High performance 2.2 Ah lithium-ion battery</li> <li>• Typically achieves 50-100 full stroke up and down cycles</li> <li>• Features LED light bar indicating capacity</li> <li>• Audible alarm when charging is required</li> <li>• Can be charged with existing table power cord or included external charging cable</li> <li>• Colour: black only</li> <li>• Includes mounting bracket, connecting cable &amp; external charging cable</li> </ul>	1,402



<b>ORDER CODE SAMPLE</b>
ITEM CODE
BA001

**PRODUCT MAP**  
 TABLE OF CONTENTS  
 MESA ELECTRIC  
 VIVA ELECTRIC  
 VIVA MANUAL  
 VIVA INCREMENTAL  
 VIVA FIXED HEIGHT  
 SOHO  
 NOLITA  
 CONTROLLERS  
 www.brc.group  

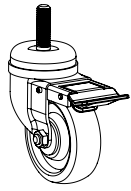
QTY 4

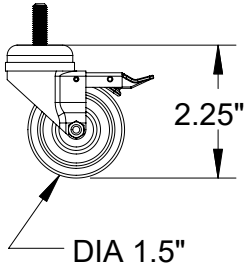

MJCMA	
FEATURES & SPECIFICATIONS	PRICE
<ul style="list-style-type: none"> <li>• Kit includes set of 4 locking casters</li> <li>• Black steel body with hard rubber black wheel</li> <li>• For retrofit on Mesa 2 leg T and C base height adjustable tables</li> <li>• For installtion, remove existing levelers and replace each with locking caster</li> </ul>	229 / Set of 4



ORDER CODE SAMPLE
ITEM CODE
MJCMA



MJCMA	
FEATURES & SPECIFICATIONS	PRICE
<ul style="list-style-type: none"> <li>• Kit includes set of 4 locking casters</li> <li>• For retrofit on Mesa 2 leg T and C base height adjustable tables</li> <li>• For installtion, remove existing levelers and replace each with locking caster</li> </ul>	229 / Set of 4



ORDER CODE SAMPLE
ITEM CODE
MJCDA

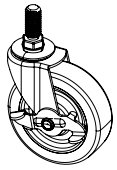

QTY 4

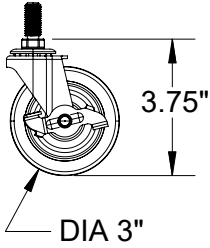

MJCVA	
FEATURES & SPECIFICATIONS	PRICE
<ul style="list-style-type: none"> <li>• Kit includes set of 4 locking casters</li> <li>• Black steel body with hard rubber black wheel</li> <li>• For retrofit on all Viva 2 leg height adjustable tables</li> <li>• For installtion, remove existing levelers and replace each with locking caster</li> </ul>	229 / Set of 4



ORDER CODE SAMPLE
ITEM CODE
MJCVA

# Height Adjustable Table Support Brackets

Height adjustable tables present unique challenges when mounting to adjacent furniture. BRC's table support brackets allow direct connection to Gallery Panels, tall storage, credenzas and other items while allowing full height adjustable functionality. These brackets have been designed specifically for our Mesa T leg and C leg bases but may be applicable to non-BRC product. Contact a BRC representative for full details.

## T Leg Rear Mount Bracket

Product Code: MABRA

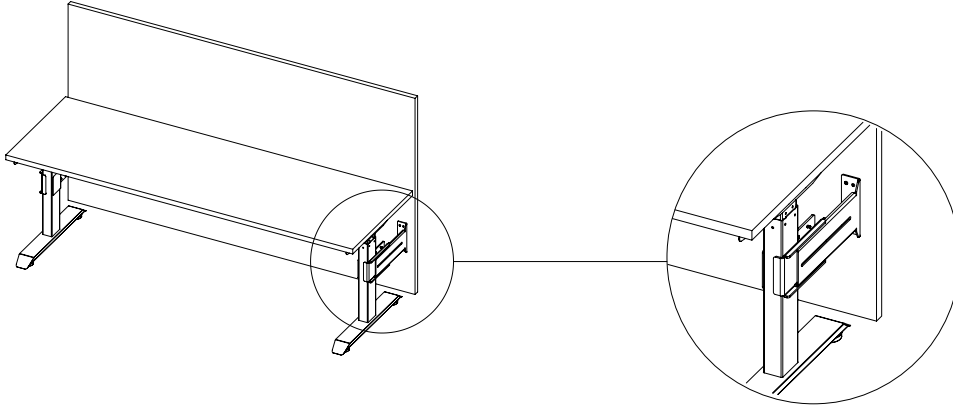

For use on Mesa T leg tables 24" and 30" deep. Connection to rear panel or similar is permanent by way of screws or bolts. Connection to T leg is a clamping mechanism that does not damage or alter the base.

## C Leg Rear Mount Bracket

Product Code: MABCA

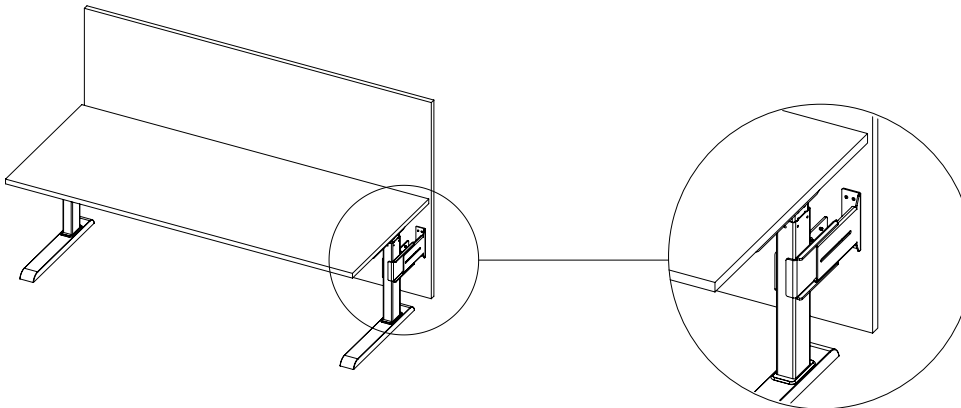

For use on Mesa C leg tables 24" and 30" deep. Connection to rear panel or similar is permanent by way of screws or bolts. Connection to T leg is a clamping mechanism that does not damage or alter the base.

## C Leg or T Leg Side Mount Bracket

Product Code: MABSA

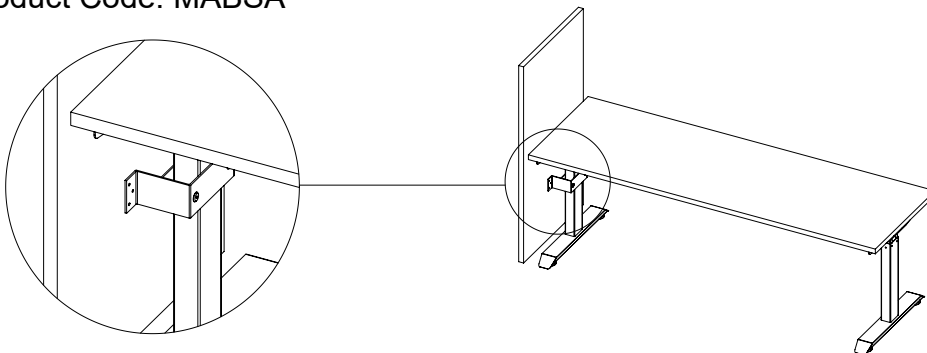

For use on Mesa C leg or T leg tables 24" and 30" deep. Connection to side panel or similar is permanent by way of screws or bolts. Connection to T leg is a clamping mechanism that does not damage or alter the base.

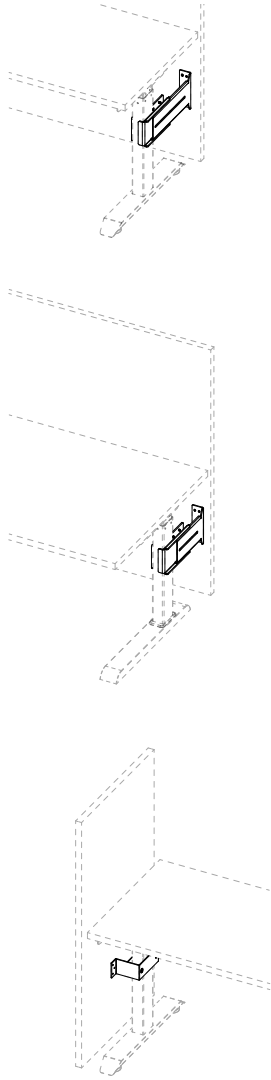

**Features & Specifications**

<b>MABRA</b>	
FEATURES & SPECIFICATIONS	PRICE
<ul style="list-style-type: none"> <li>• For application to the rear of a height adjustable T leg table</li> <li>• Works with BRC Mesa Table</li> </ul>	215

<b>MABCA</b>	
FEATURES & SPECIFICATIONS	PRICE
<ul style="list-style-type: none"> <li>• For application to the rear of a height adjustable C leg table</li> <li>• Works with BRC Mesa Table</li> </ul>	215

<b>MABSA</b>	
FEATURES & SPECIFICATIONS	PRICE
<ul style="list-style-type: none"> <li>• For application to the side of a height adjustable table</li> <li>• Works with BRC Mesa T leg and C leg tables</li> </ul>	151



<b>ORDER CODE SAMPLE</b>
ITEM CODE
MABRA

- Available in all standard metal finishes
- Includes all hardware to attach to Mesa height adjustable base
- May be compatible with other height adjustable base tables; contact BRC customer service for further details

For more information contact: [quotes@brc.group](mailto:quotes@brc.group)

24 Armstrong Ave  
Georgetown, ON L7G 4R9  
Phone: 905.873.8509  
Toll Free: 1.877.260.4309  
[info@brc.group](mailto:info@brc.group)

