



2024 SA Ariba Sourcing Project : WS3472349042,  
Ariba Master Agreement CW2240515

Price Guide 2024

# Thank you for choosing BRC

Established in 1979 and incorporated in 1983, BRC Group has grown into a leader in the research, development and manufacturing of high quality ergonomic office furniture. BRC is a Canadian-owned private company with modern manufacturing facilities in Georgetown, Ontario, Canada.

BRC is a forerunner in blending environmental initiatives with the manufacturing of renewable and recyclable products. BRC uses materials and manufacturing processes which virtually eliminate Volatile Organic Chemical (VOC) emissions in the office environment. Raw materials are responsibly sourced, assuring that only the best and most sustainable components are converted to finished goods. BRC is committed to developing and offering the best-value products for the middle and higher end markets.

From OEM solutions to obscure designer requests to simply striving to be better, BRC provides creative and innovative customized solutions to complement any environment and use. Flexible manufacturing offers the ability for BRC to respond to client's special needs rather than having standard catalogue solutions. A wide collection of textiles, laminate finishes and wood veneer allows companies and individuals to express their brand and culture through a unique signature look.

All furniture is designed and manufactured to meet or exceed ANSI-BIFMA standards. Standard construction uses a combination of 3/4" and metal to metal commercial grade connections for solid enduring assembly. The newest edge banding technology, in which the edge tape is melted directly to the edge of the board, enables BRC to manufacture products with virtually invisible glue lines.

The BRC Team works hard to earn and keep your business - our success depends on it. If you have any questions or inquires, please contact us at [info@brc.group](mailto:info@brc.group) or toll free at 1-877-260-4309.

We appreciate your business and look forward to hearing from you.

## Warranty, Terms & Conditions

BRC is pleased to offer one of the most competitive warranties in the industry. All furniture products carry a 12 year limited structural warranty. BRC furniture panel and table electrical cabling carry a 3 year limited warranty. All moving user adjustable components carry a 5 year limited structural warranty. All other electrical or electronic elements of BRC furniture carry a 1 year limited warranty.

For full warranty details, terms and conditions, please visit [www.brc.group/warranty](http://www.brc.group/warranty)

## Shipping Rates & Policies

Shipping costs are calculated based on net order value and destination. In many cases, the freight cost may be included in your order. For detailed information, visit our website at [www.brc.group/freight](http://www.brc.group/freight)

# General Guidance & Ordering

**PRODUCT NAME & DESCRIPTION** → Rectangular Fit Table - 4 Leg

**NOMINAL OR ACTUAL SIZE IN INCHES** → NOMINAL SIZE

**ALL PRICES IN LIST** → PRICE M1, H1, K1

**PRODUCT CODE** → TFRTT

**LAMINATE OPTIONS (ACTUAL THICKNESS in/mm):**  
 M1 - 1" THICK LPL (1.016"/25.8mm)  
 H1 - 1" THICK HPL (1.063"/27.0mm)  
 K1 - 1.25" THICK HPL KNIFE EDGE (1.339"/34mm)

**HYPERLINK TO OTHER ITEMS WITHIN DOCUMENT** → PRODUCT MAP, CONFERENCE TABLES, MEDIA TABLES, PARSONS TABLES, MEETING & CASUAL TABLES, NEST/TRAINING TABLES

**USE THIS EXAMPLE AS A GUIDE TO ORDER. ENTER OPTION AS REQUIRED.**

**DESCRIPTION OF FEATURES AND INCLUDED ITEMS**

**OPTIONS AND FEATURES AVAILABLE AT NO EXTRA CHARGE**

**OPTIONAL EXTRAS AVAILABLE BUT AT ADDITIONAL CHARGE. ADD CODE WHERE APPLICABLE, AND ADDITIONAL PRICE TO TOTAL**

**POWER AND DATA OPTIONS AVAILABLE**

**ORDER CODE SAMPLE**

LINE 1	TABLE	ITEM CODE	WIDTH	DEPTH	LAMINATE	OPTION
	TFRTT		W96	D48	M1	CC
LINE 1.1	POWER & DATA	POWER OPTION	FINISH / TRIM FINISH / COVER CODE	BODY FINISH / OPTION	POWER QTY	
		AF2RE	SLV	D	1	

**Features & Specifications**

- Laminate codes - M1: 1" LPL, H1: 1" HPL, K1: 1.25" knife edge (top only)
- Base legs available in chrome only; upper frames are black
- Height is 29" nominal, including levellers, including levellers
- Available in all standard laminates
- For 3" curved corners add option code "CC" and \$314

**No Charge Options**

**Optional Extra**

**POWER & DATA**

**AF2RE** Finish: Black (BLK), Silver (SLV), White (WHT), Anodized Aluminum (BAA), Stainless Steel (BSS)

**AF3AE** Trim Finish: Black (BLK), Silver (SLV), White (WHT)

**AU2FE** Body Finish: White (WHT), Gray (GRY), Black (BLK), Orange (ORN), Red (RED), Green (GRN), Blue (BLU)

**Cover Code:** F-AL, F-S, F-B, F-W

**Option (Data & Telecom):** C, K

**LIGHT GREY BOXES INDICATE MANDATORY SELECTION FOR ORDERING**

**DARKER GREY BOXES CONTAIN CODE DESCRIPTIONS**

**ORDER CODE SAMPLE**

LINE 1	TABLE	ITEM CODE	WIDTH	DEPTH	LAMINATE	OPTION
	TFRTT		W276	D48	M1	CC
LINE 1.1	POWER & DATA	POWER OPTION	FINISH / TRIM FINISH / COVER CODE	BODY FINISH / OPTION	POWER QTY	
		AF2RE	SLV	D	1	

**ITALICS INDICATE PRODUCT OPTIONS**

**POWER & DATA OPTION**

**FINISH OPTION**

**ADDITIONAL FINISH OPTION**

**POWER MODULE QUANTITY**

**PURCHASE ORDER LINE ITEMS FOR ABOVE: TFRTT W276 D48 M1 CC AF2RE SLV D 1**

**WHITE BOXES INDICATE EXTRA OPTIONS NOT MANDATORY FOR ORDERING. FOR DEFAULT OR NO OPTIONS, LEAVE BLANK**

# Power Module Guidance & Ordering

## Orders with Power

Power modules are optional when ordering tables. Prices should be added in addition to the table price according to the “Power Options” pages for each product. When ordering a table that requires power, simply follow these steps:

Step 1 - On the first line of the purchase order, indicate the Item code with width, depth and laminate type, these items are required to be specified.

Step 2 - At the end of the table code add the option if required (in this example, “CC”). If selected add the option charge to the table price.

Step 3 - Specify the power options on the second line of the purchase order, Line 1.1. Add multiple lines for additional power options (eg. Line 1.2).

LINE 1	TABLE	ITEM CODE	WIDTH	DEPTH	LAMINATE	OPTION
		TFRTT	W96	D48	M1	CC
LINE 1.1	POWER & DATA	POWER OPTION	FINISH / TRIM FINISH / COVER CODE	BODY FINISH / OPTION	POWER QTY	
		AF2RE	SLV	D	1	

A complete order code including power and the optional curved corner for the above is: **TFRTT W96 D48 M1 CC AF2RE SLV D 1**

## Orders without Power

When ordering a table without power, omit the power and data section:

LINE 1	TABLE	ITEM CODE	WIDTH	DEPTH	LAMINATE	OPTION
		TFRTT	W96	D48	M1	CC
LINE 1.1	POWER & DATA	POWER OPTION	FINISH / TRIM FINISH / COVER CODE	BODY FINISH / OPTION	POWER QTY	
		AF2RE	SLV	D	1	

A complete order code without power and optional curved corner for the above is: **TFRTT W96 D48 M1 CC**

## Finish Abbreviations

The following abbreviations are used throughout this guide and can be specified when ordering.

Finish	Abbreviated Code
Black	<b>BLK</b>
Silver	<b>SLV</b>
White	<b>WHT</b>
Anodized Aluminum	<b>BAA</b>
Stainless Steel	<b>BSS</b>
Grey	<b>GRY</b>
Orange	<b>ORN</b>
Red	<b>RED</b>
Green	<b>GRN</b>
Blue	<b>BLU</b>

# General Specifications

## Summary

BRC's tables series product can be used as an effective way to add boardroom, meeting and occasional workspaces to any office environment. The information on this page applies to all items in this price guide. For specific information on the product type, consult its section specification page or its individual product page.

## Corner Options

Standard configurations include square corners but can be configured with 3" radius corners as an optional upcharge.

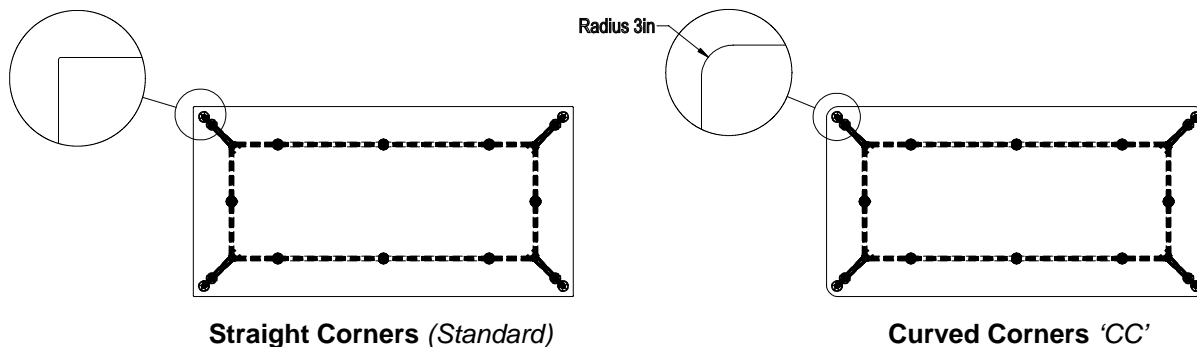

## Laminates

Most laminates are available in matching low pressure (LPL) and high pressure (HPL) finishes in 1.00" and 1.25" thick material with 2.5mm edge trim. Consult BRC's current finish line up for specific details on availability at [www.brc.group/materials](http://www.brc.group/materials). When specifying laminate top finish codes, the code applies to the worksurface or top of product only. These codes are:

*M1* - Indicates 1.00" thick LPL laminate

*H1* - Indicates 1.00" thick HPL  
(actual thickness is 1.125")

*K1* - Indicates 1.25" thick HPL laminate with knife edge

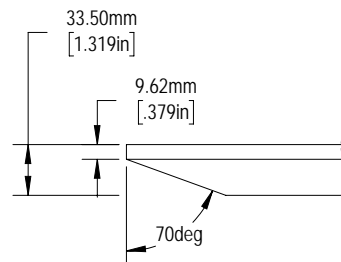
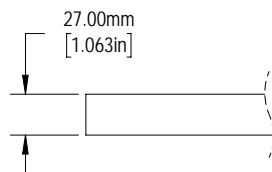
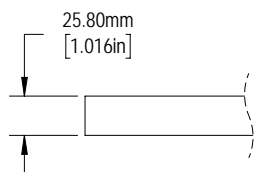

## Custom Sizing

BRC has built a reputation on custom tailored product based on our standard offering. Most items can be ordered in sizes that are not listed in this price guide, especially sizes that are between the minimum and maximum sizes offered. Please contact your BRC representative to help with your custom project.

# Cleaning & Maintenance

## BEST PRACTICES

To keep your furniture products looking their best, BRC recommends the following general care and maintenance:

### Low Pressure (LPL) LAMINATES Cleaning:

Dust laminated surfaces off prior to cleaning. Wet a damp cloth with water, a mild soap or one of our approved cleaning products. Do not use abrasive cleaners as they may scratch or affect the surface appearance. Wipe the surface with the grain (where applicable) using a dry soft cloth.

Approved cleaning products: Glass Plus®, Dawn®, Pledge®, Mr. Clean®, Windex®,

For disinfecting surfaces use products such as: LYSOL®, VIREX®, PURELL®, VIROX®

After use of the above disinfectants ensure that the surfaces are wiped with a damp cloth to remove any product residue.

Take note that any product with Hydrochloric, Sulfuric, or Phosphoric acid may permanently damage the surface. Abrasive elements and excessively acidic or alkaline solutions should be avoided. Prolonged exposure to wet surfaces and/or direct contact with water should be avoided.

### High Pressure (HPL) LAMINATES Cleaning:

Dust laminated surfaces off prior to cleaning. Wet a damp cloth with water, a mild soap or one of our approved cleaning products. Do not use abrasive cleaners as they may scratch or affect the surface appearance. Wipe the surface with the grain (where applicable) using a dry soft cloth.

Approved cleaning products: Glass Plus®, Dawn®, Pledge®, Mr. Clean®, Windex®,

For disinfecting surfaces use products such as: LYSOL®, VIREX®, PURELL®, VIROX®, Fantastik®, multi-surface disinfectant, Clorox® Disinfecting Wipes, Caviwipes™, Cavicide™

After use of the above disinfectants ensure that the surfaces are wiped with a damp cloth to remove any product residue.

Take note that any product with Hydrochloric, Sulfuric, or Phosphoric acid may permanently damage the surface. Abrasive elements and excessively acidic or alkaline solutions should be avoided. Prolonged exposure to wet surfaces and/or direct contact with water should be avoided.

### Acrylic Tiles And Panels:

Dust regularly to keep surfaces free of dust particles. Clean any dirt or stain with a damp cloth. Do not use chemical cleaners or window cleaners as it may alter or permanently affect the surface appearance.

### Tempered & Laminated Glass:

Dust regularly to keep surfaces free of dust particles. Clean any dirt or stain with a damp cloth. Do not use chemical cleaners or window cleaners as it may alter or permanently affect the surface appearance.

### Edge Trim:

To remove minor scuff marks and general dirt from bases and connectors, use warm water and a soft cloth. Do not use harsh abrasive cleaners, as they may cause permanent scratches on the surface.

### Painted Metals:

Clean these products, use a damp cloth, using only a small amount of lukewarm water if necessary. Abrasive elements and excessively acidic or alkaline solutions should be avoided. Prolonged exposure to wet surfaces and/or direct contact with water should be avoided.

### Standard Fabrics:

Standard Care Label W-S. Clean with water based cleaning agents, foam or pure, water free solvents. Vacuuming or light brushing is recommended to prevent dust and soil buildup.

### Bleach Cleanable Fabrics:

Bleach is an effective disinfectant, which means it kills most bacteria, fungi and viruses. When fabrics need to be disinfected or sterilized, use a 1:10 household bleach-to-water solution.



Do not saturate or soak furniture with cleaner



Use spray or damp cloth only



Wipe with damp cloth using fresh water after cleaning

## Conference Tables: Fit, Nova, Disc & Panel Base Tables

Introduction

Power Options

Wire Management

### Fit Base Tables

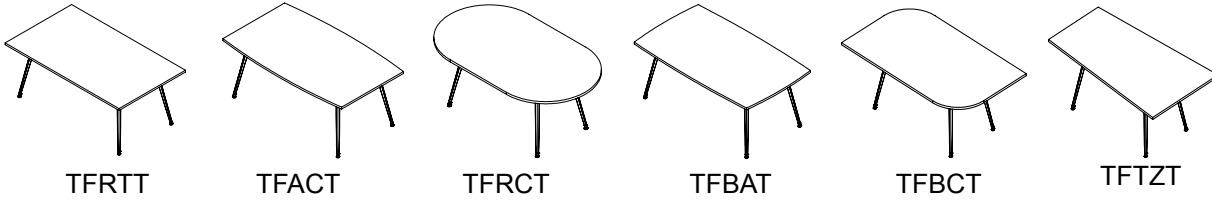

### Rectangle Nova Base Tables

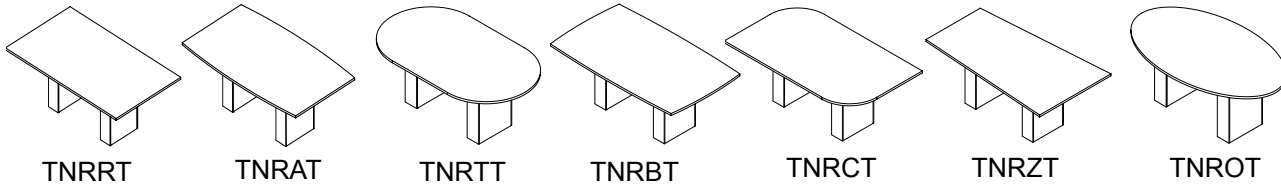

### Triangle Nova Base Tables

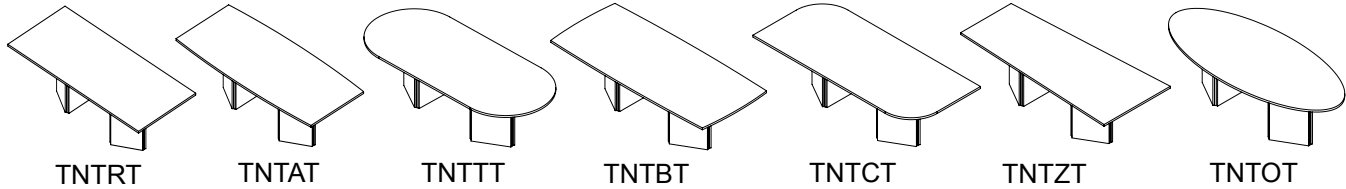

### Disc Base Tables

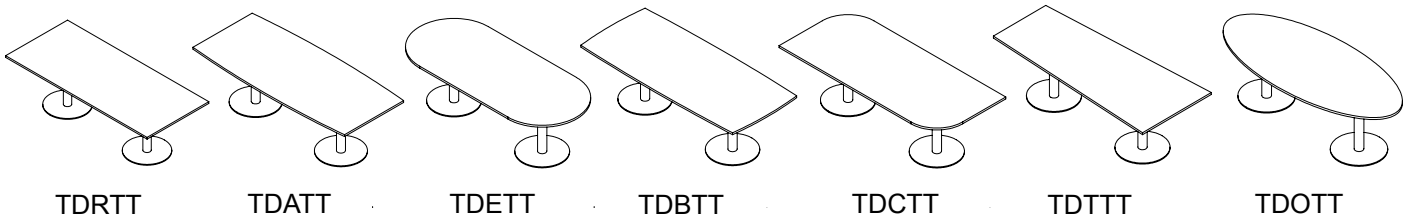

### Panel Base Tables

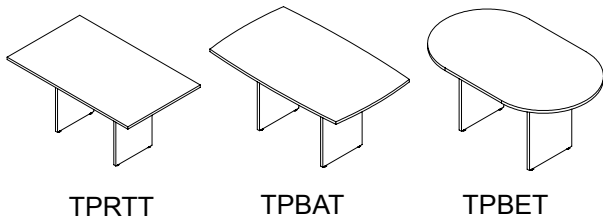

### Meeting Tables: Fit, Nova and Panel Base

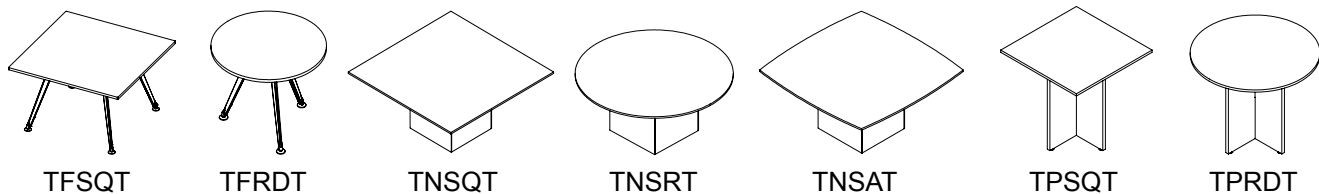

## Wall-Mount Conference Tables: Fit, Nova, Disc & Panel Base

### Fit Base Tables

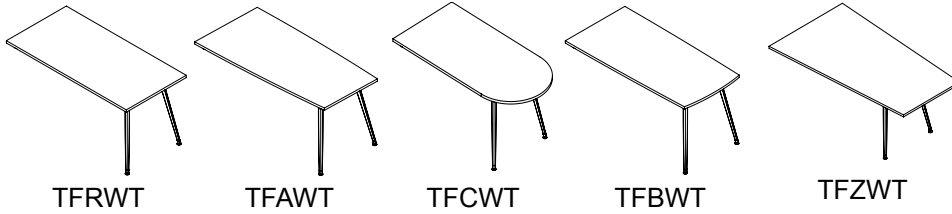

### Rectangle Nova Base Tables

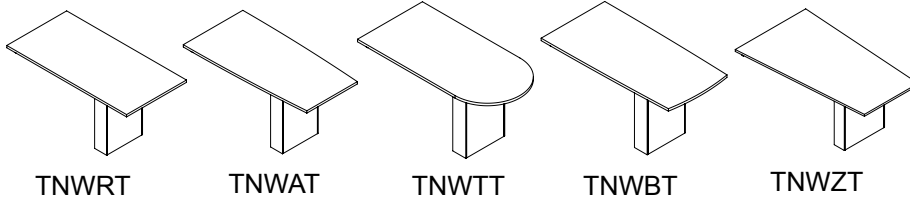

### Triangle Nova Base Tables

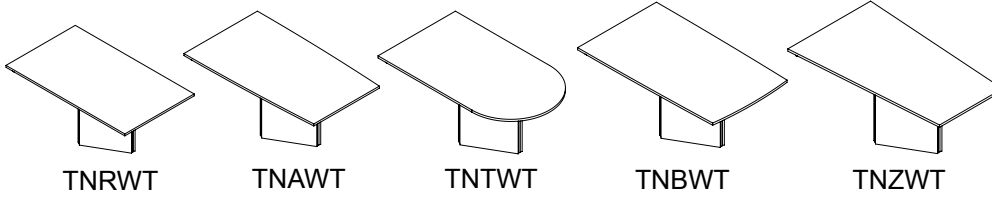

### Disc Base Tables

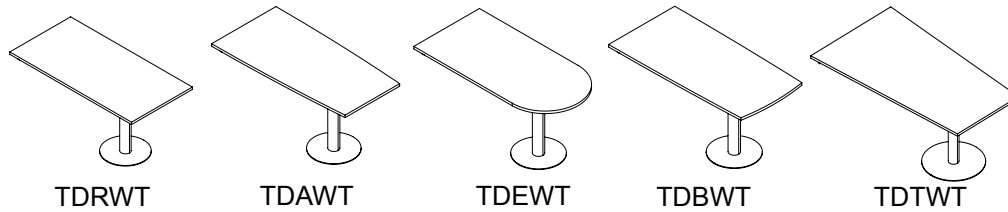

### Panel Base Tables

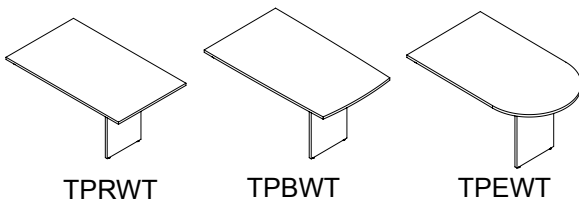

### Disc Base Extension Tables

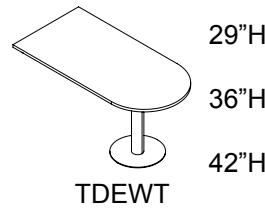

### Media Tables

Introduction

Power Options

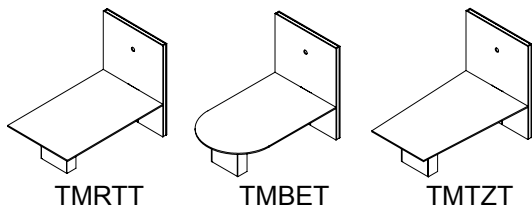

### Parsons & Console Tables

Introduction

Power Options

Wire Management

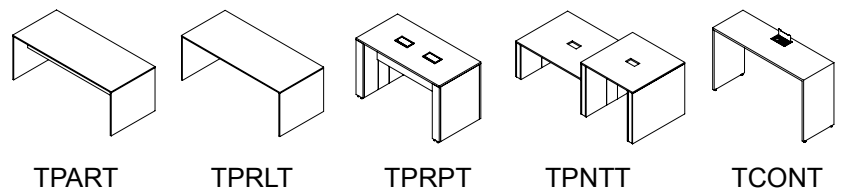

## Meeting, Casual, Occasional Tables & Accessories

Introduction

Power Options

Wire Management

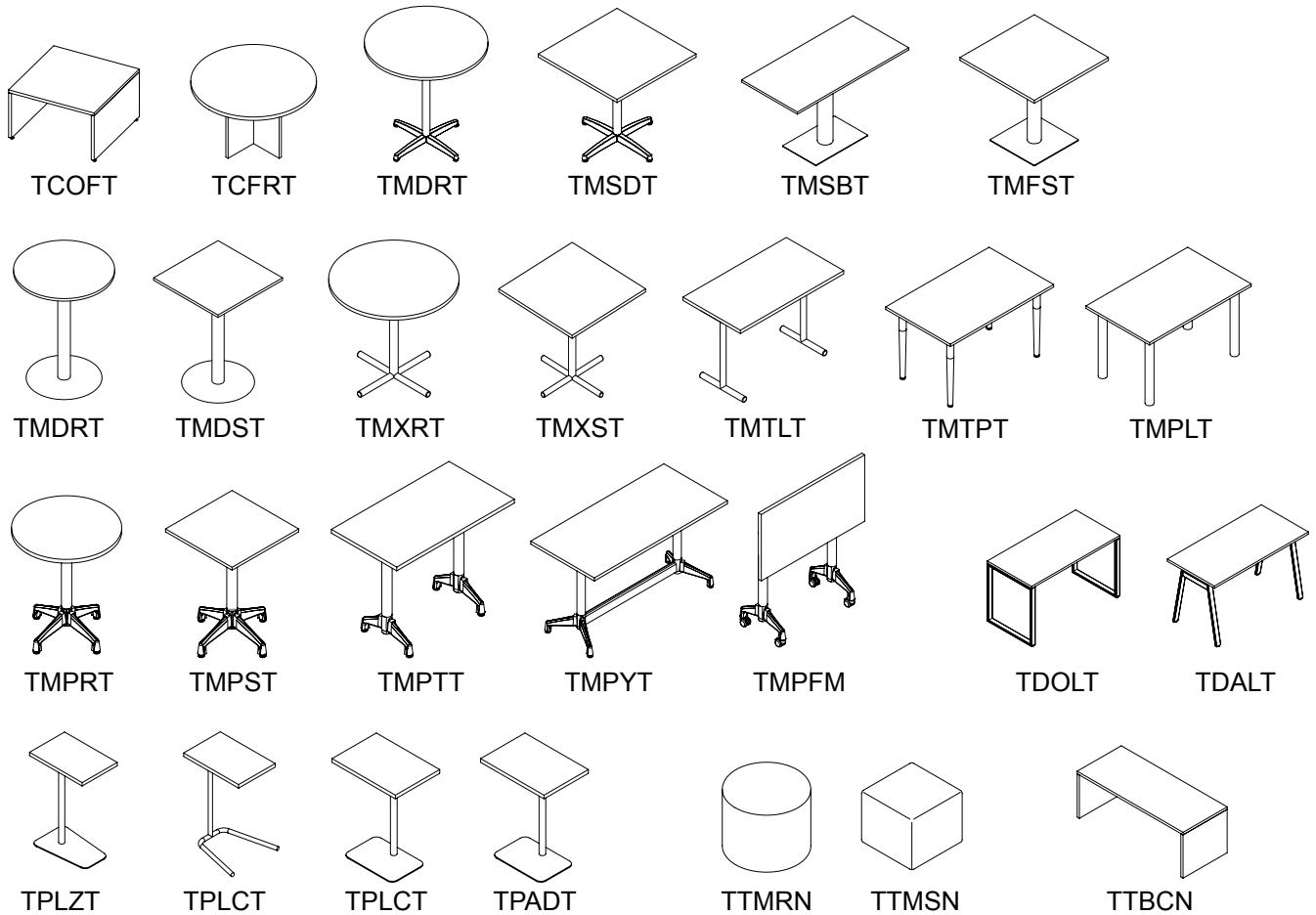

## Training Tables

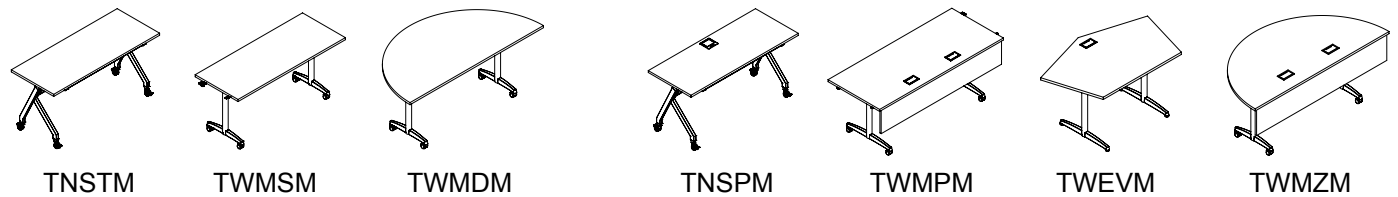

## Nesting Training Table with Daisy Chain Power Configurations

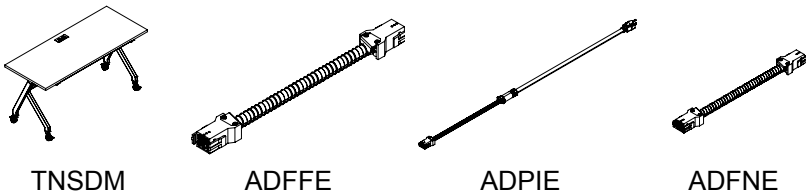

## Accessories

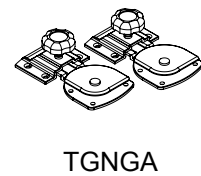

# Conference Tables



For more than 20 years, BRC’s Architectural Base Tables were a staple in our product line-up, even going so far as to manufacture these tables for our OEM partners. Building on that history, BRC introduces its new line of boardroom tables called Nova. Updated bases, table shapes and wire management take your boardroom to the next level without breaking the bank. Our new disc base addition and also the updated Fit and Panel tables offering round out our extensive boardroom and meeting table selection.

PRODUCT MAP
CONFERENCE TABLES
MEDIA TABLES
PARSONS TABLES
MEETING & CASUAL TABLES
NEST TRAINING TABLES
 www.brc.group

# Conference Tables Section Guide

## Summary

Table sections are driven by the overall table width. Regardless of the base type, all tops are sectioned as below.

From 72" up to 96" width, the table will be one section only. From 108" up to 192" width, the table will be in two sections. From 204" up to 288" width, the table top will be three sections.

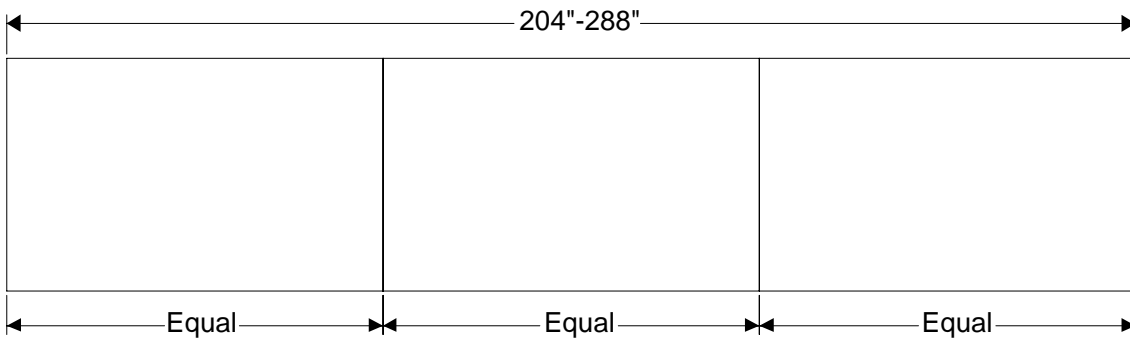
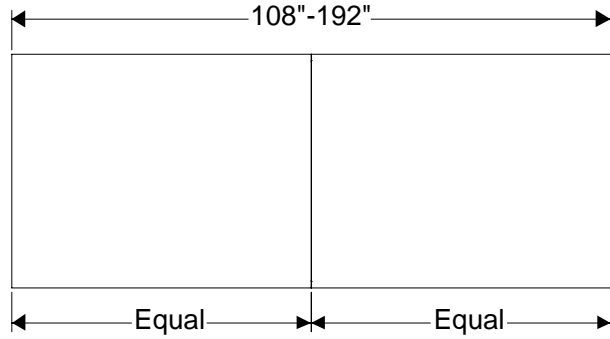
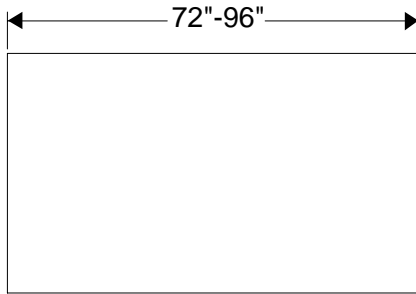





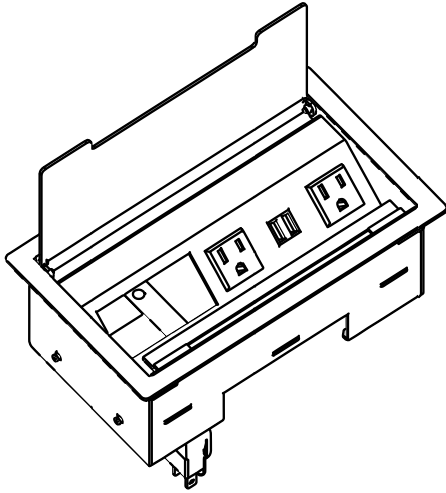





# Power & Data Options: Conference Tables

## AF2RE: Interact G2 Power Module



AF2RE	FINISH	
	PRICE (BLACK, SILVER, WHITE)	PRICE (ANODIZED ALUMINUM, STAINLESS STEEL)
FEATURES & SPECIFICATIONS		
<ul style="list-style-type: none"> <li>• Two power outlets on top</li> <li>• Additional power outlet on bottom for daisy chaining</li> <li>• Two USB ports</li> <li>• Hinged lid with brush gasket</li> <li>• 144" Black corded plug</li> <li>• Finish options: black, silver or white, Brushed anodized aluminum, brushed stainless steel</li> <li>• Product ships with blank plate unless additional options below are selected when ordering</li> </ul>	1,221	1,921

OPTION	FEATURE(S)	PRICE
A	 HDMI	ADD 345
B	 RJ45 CAT6	ADD 214
C	 (2) RJ45 CAT6	ADD 426
D	 (3) RJ45 CAT6	ADD 637
E	 RJ11 CAT3, RJ45 CAT6, USB	ADD 715
F	 RJ11 CAT3, RJ45 CAT6	ADD 319
G	 RJ11 CAT3, (2) RJ45 CAT6	ADD 531
H	 (3) RJ45 CAT5E	ADD 637
J	 VGA, (2) RJ45 CAT6	ADD 680
K	 VGA, RJ45 CAT6, STEREO 3.5	ADD 573

### ORDER CODE SAMPLE

LINE 1	TABLE	ITEM CODE	WIDTH	DEPTH	LAMINATE	OPTION
		TFRTT	W276	D48	M1	CC
LINE 1.1	POWER & DATA	POWER OPTION	FINISH / TRIM FINISH / COVER CODE	BODY FINISH / OPTION	POWER QTY	
		AF2RE	SILVER	D	1	

# Power & Data Options: Conference Tables

## AF3AE: Trio Flush Mount

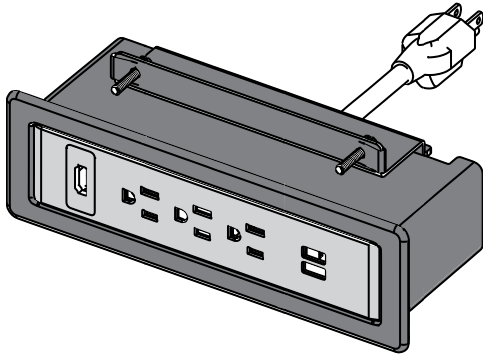

BODY  
TRIM

### AF3AE

FEATURES & SPECIFICATIONS	PRICE
<ul style="list-style-type: none"> <li>• Triple outlet</li> <li>• Two USB ports</li> <li>• 72" Corded plug</li> <li>• Finish options: Trim: black, silver or white Body: white, grey, black, orange, red, green, blue</li> </ul>	688

#### ORDER CODE SAMPLE

LINE 1	TABLE	ITEM CODE	WIDTH	DEPTH	LAMINATE	OPTION
		TFRTT	W276	D48	M1	CC
LINE 1.1	POWER & DATA	POWER OPTION	FINISH / TRIM FINISH / COVER CODE	BODY FINISH / OPTION	POWER QTY	
		AF3AE	SILVER	BLUE	1	

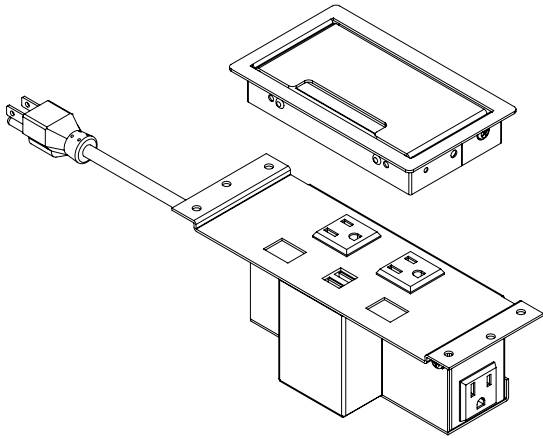

# Power & Data Options: Conference Tables

## AU2FE: Vila Undermount



AU2FE	
FEATURES & SPECIFICATIONS	PRICE
<ul style="list-style-type: none"> <li>• Two power outlets</li> <li>• Two USB charging ports</li> <li>• 72" Black corded plug</li> <li>• Base finish options: black or silver</li> <li>• Optional data, video and stereo options as per below</li> <li>• Select cover grommet to complete product</li> </ul>	814

COVER		
MODEL	FINISH	PRICE
F-AL	BRUSHED ALUMINUM	ADD 464
F-S	SILVER PAINT	ADD 233
F-B	BLACK PAINT	ADD 233
F-W	GLOSS WHITE PAINT	ADD 233

OPTION	FEATURE(S)	PRICE
C	 (2) RJ45 CAT6	ADD 422
K	 VGA, RJ45 CAT6, STEREO 3.5	ADD 699

### ORDER CODE SAMPLE

LINE 1	TABLE	ITEM CODE	WIDTH	DEPTH	LAMINATE	OPTION
		TFRTT	W276	D48	M1	CC
LINE 1.1	POWER & DATA	POWER OPTION	FINISH / TRIM FINISH / COVER CODE	BODY FINISH / OPTION	POWER QTY	
		AU2FE	F-S	K	1	

# Power & Data Locations: Conference Tables

## Summary

By default, electrical modules for Fit, Nova and Disc base, when specified from this price guide, are located in the center of each section. A sample of their location is shown in the following drawings.

## Single Section Table

Only one power module can be selected and it will be located as shown below:

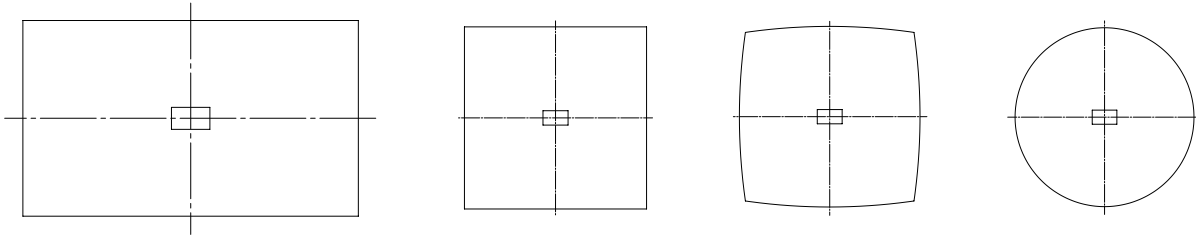

## Dual Section Table

Only two power module can be selected and it will be located as shown below:

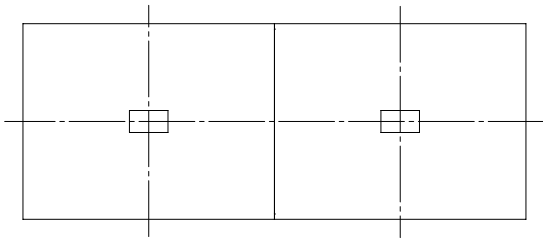

## Three Section Table

There is option to choose either one , two, or three power modules and based on the selection it will be located as shown below:

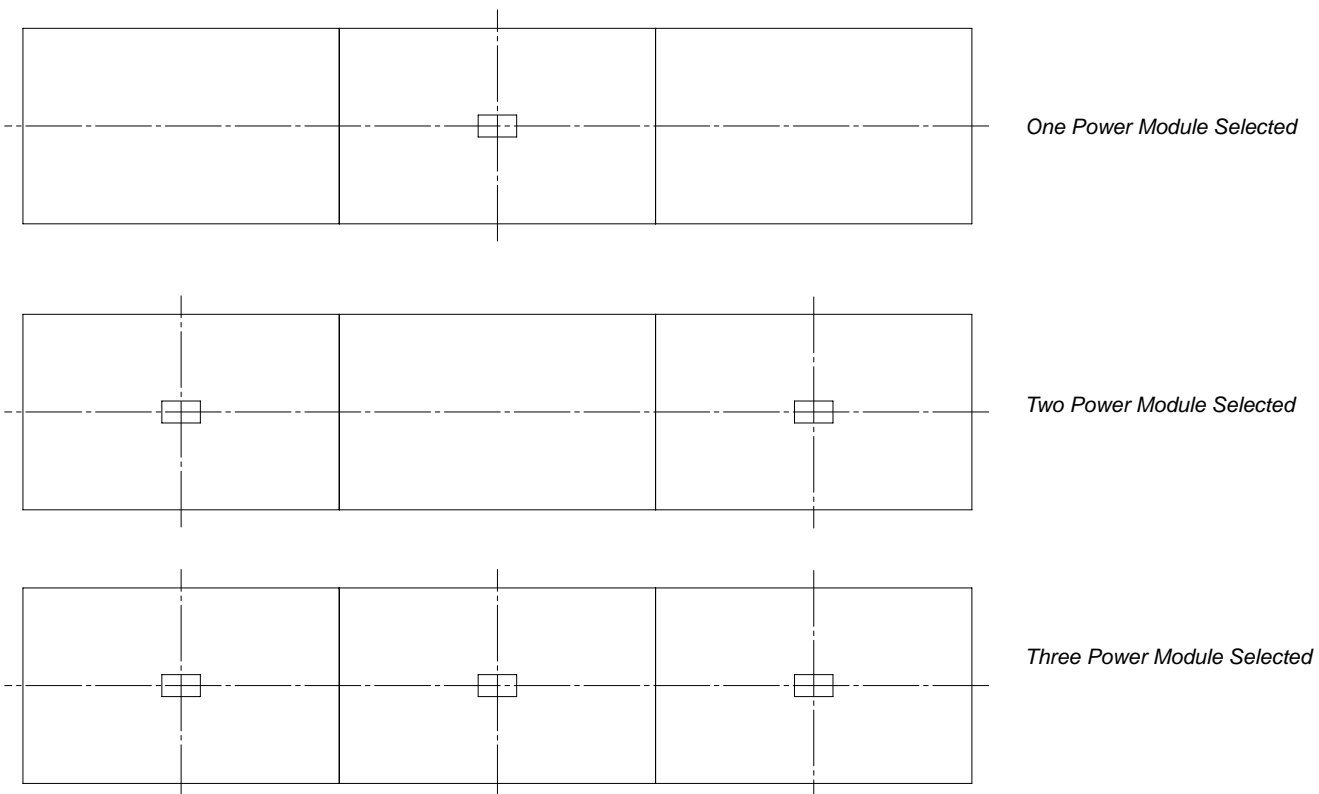

# Wire Management: Nova Base Tables

## Rectangle Nova Base Tables

Tables include wire management through the modesty and base as standard.

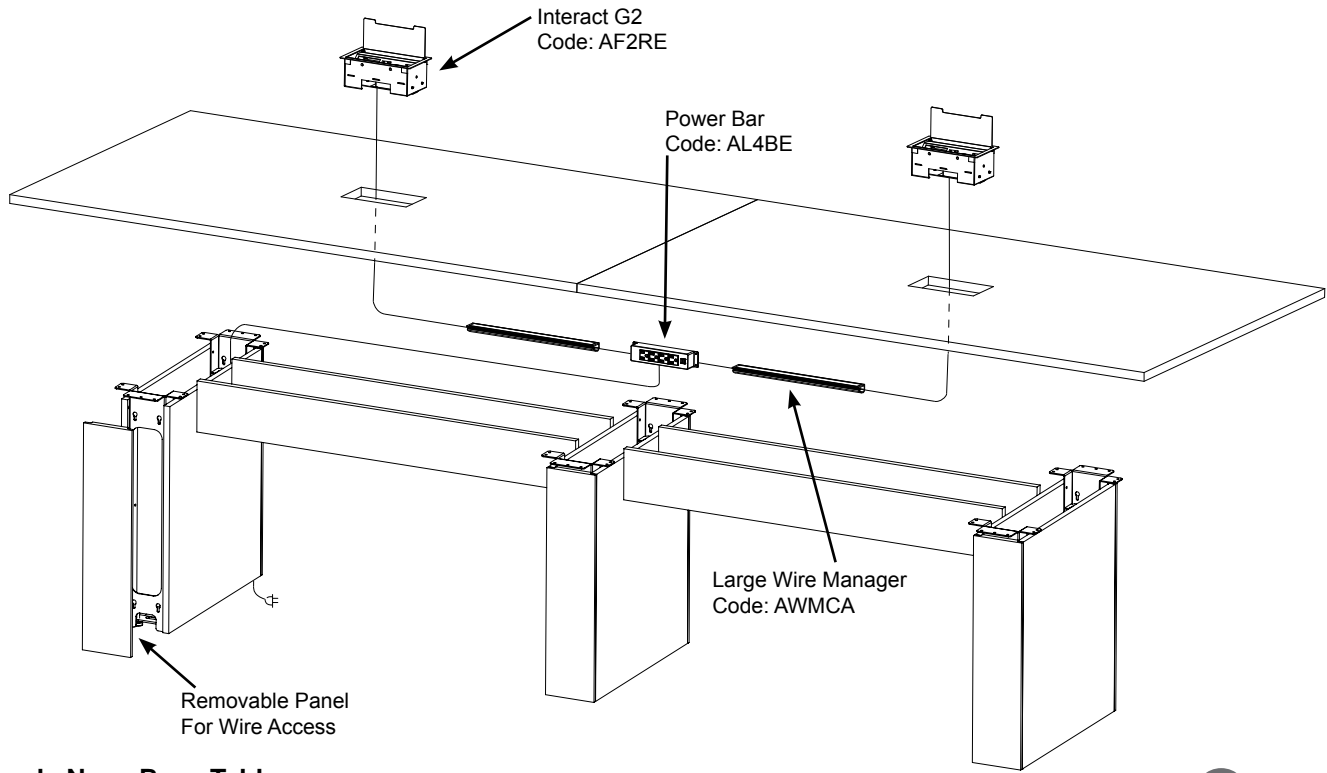

## Triangle Nova Base Tables

Tables include wire management through the modesty and base as standard.

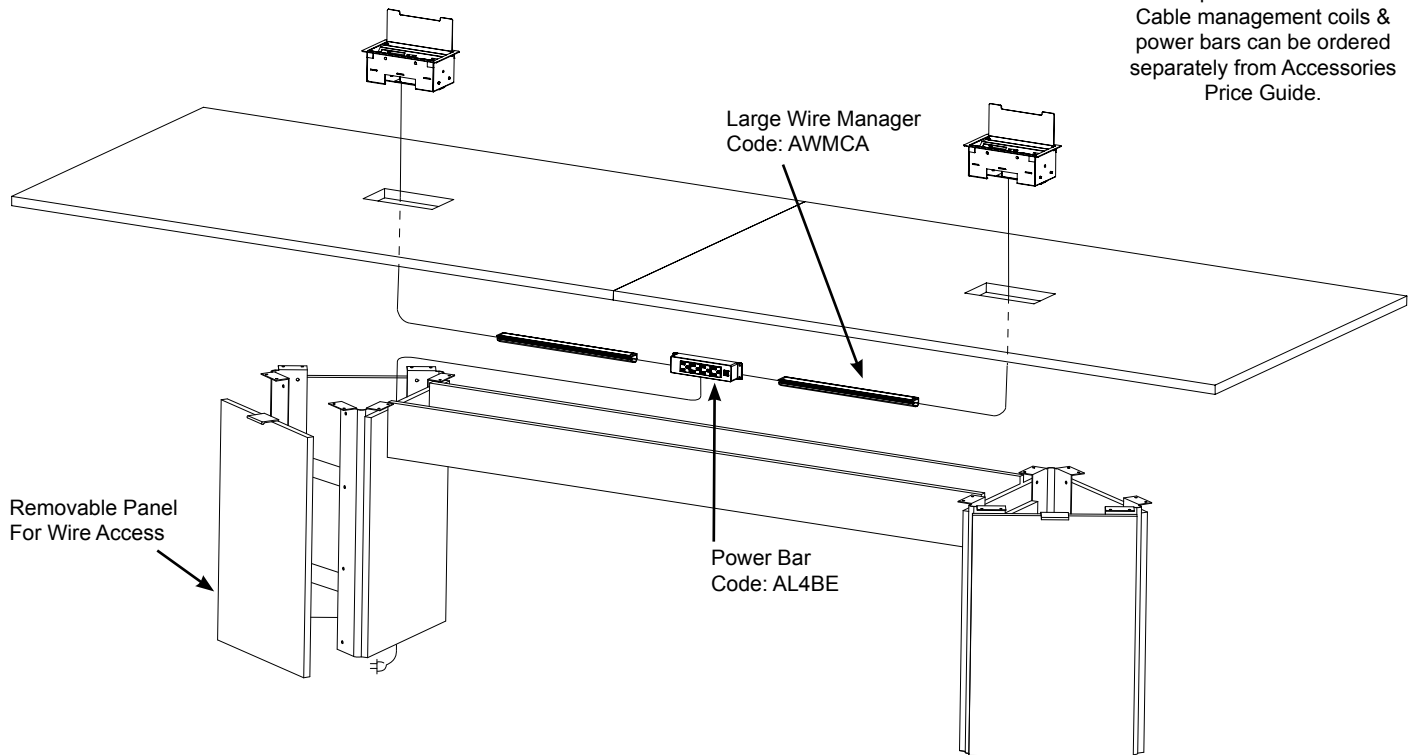

Wire managers will be included with any purchase of power modules. Cable management coils & power bars can be ordered separately from Accessories Price Guide.

# Wire Management: Fit & Disc Base Tables

## Fit Table

Under table wire management is included when tables are specified with a power module. Wire management to the floor is not provided and can be tailored to the installations individual requirements. Wire coils, spines and other solutions can be specified using BRC's Accessories Price Guide found on our website.

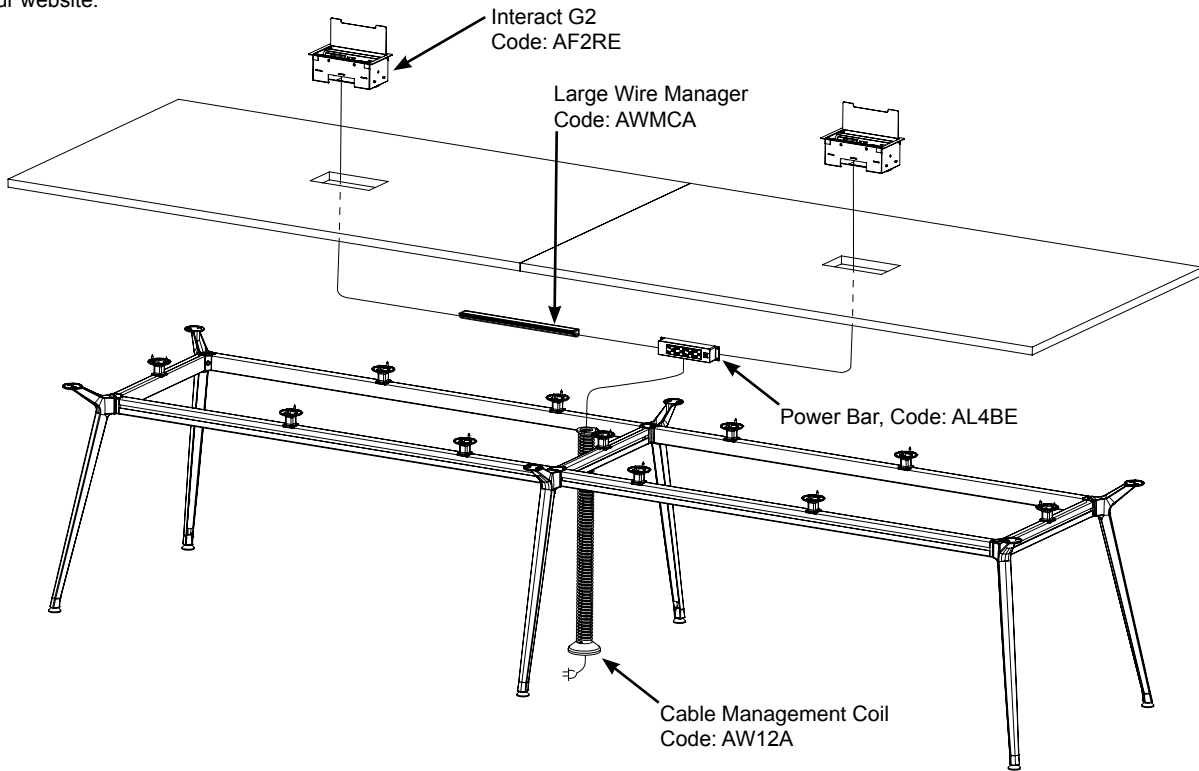

## Disc Base Tables

Under table wire management is included when tables are specified with a power module. Wire management to the floor is not provided and can be tailored to the installations individual requirements. Wire coils, spines and other solutions can be specified using BRC's Accessories Price Guide found on our website.

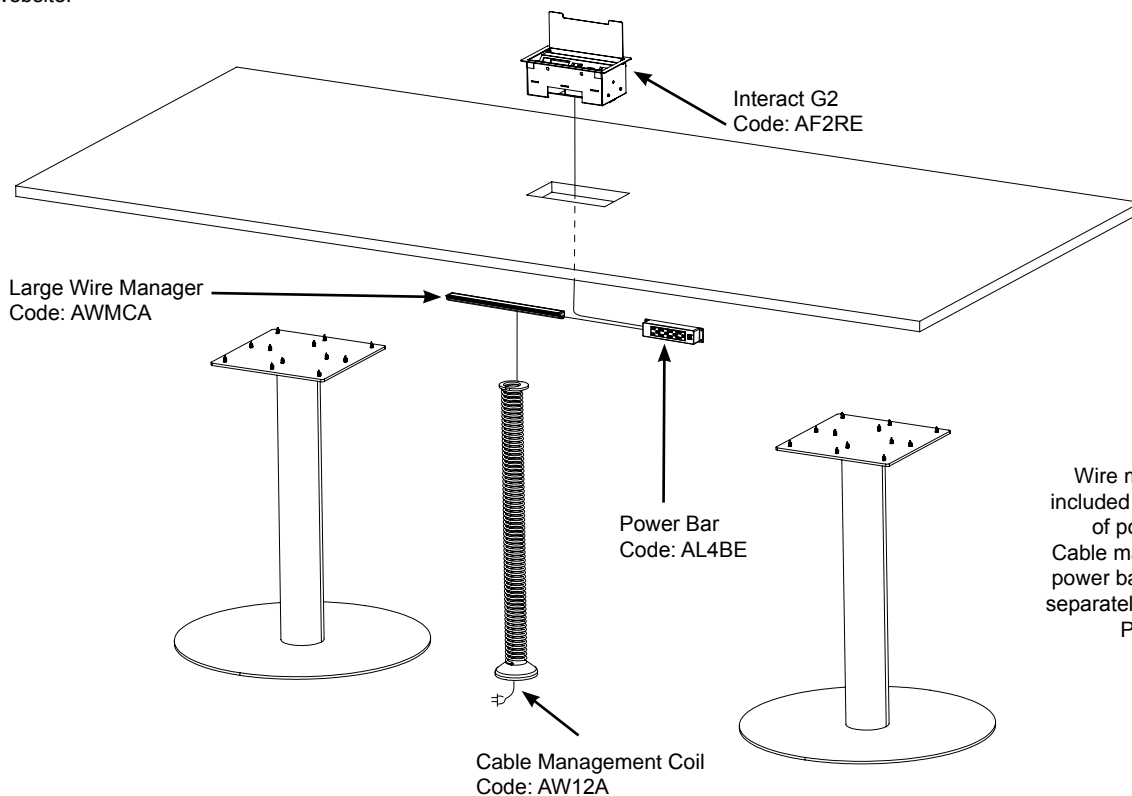

Wire managers will be included with any purchase of power modules. Cable management coils & power bars can be ordered separately from Accessories Price Guide.

# Wire Management: Panel Base Tables

## Panel Base Table

Under table wire management is included when tables are specified with a power module. Wire management to the floor is not provided and can be tailored to the installations individual requirements.

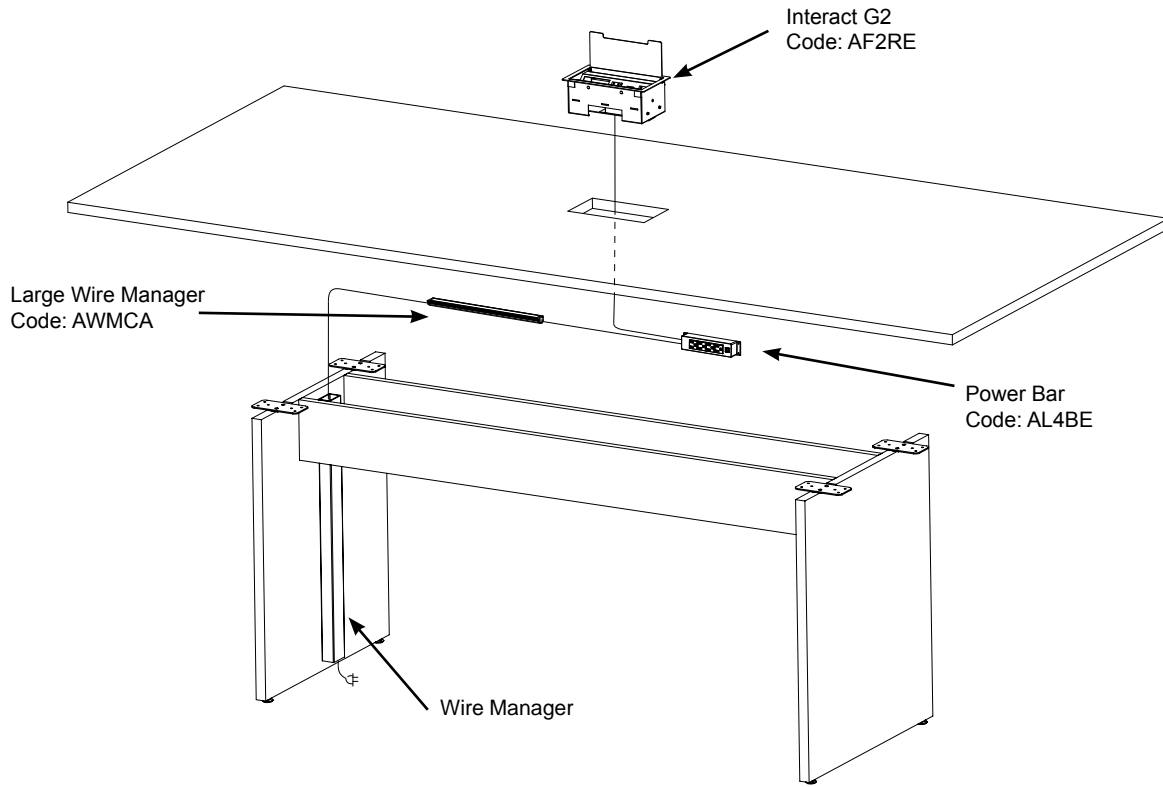

Wire managers will be included with any purchase of power modules. Cable management coils & power bars can be ordered separately from Accessories Price Guide.

# Wire Management: Wall-Mount Conference Tables

## Wall-Mount Conference Tables

Under table wire management is included when tables are specified with a power module. Wire management to the floor is not provided and can be tailored to the installations individual requirements. If required, a grommet option is available to run cables from underneath to above the worksurface to accommodate wall mount electronics or similar. The grommet is centered and distanced four inches from the wall as shown below. Specify 'GC' when ordering.

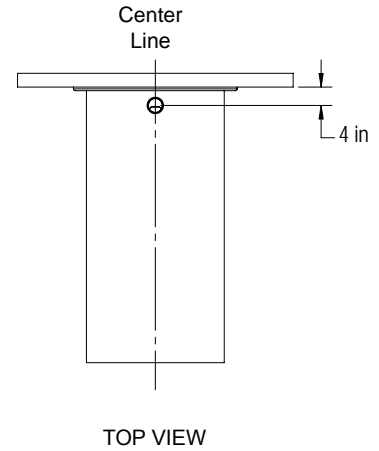
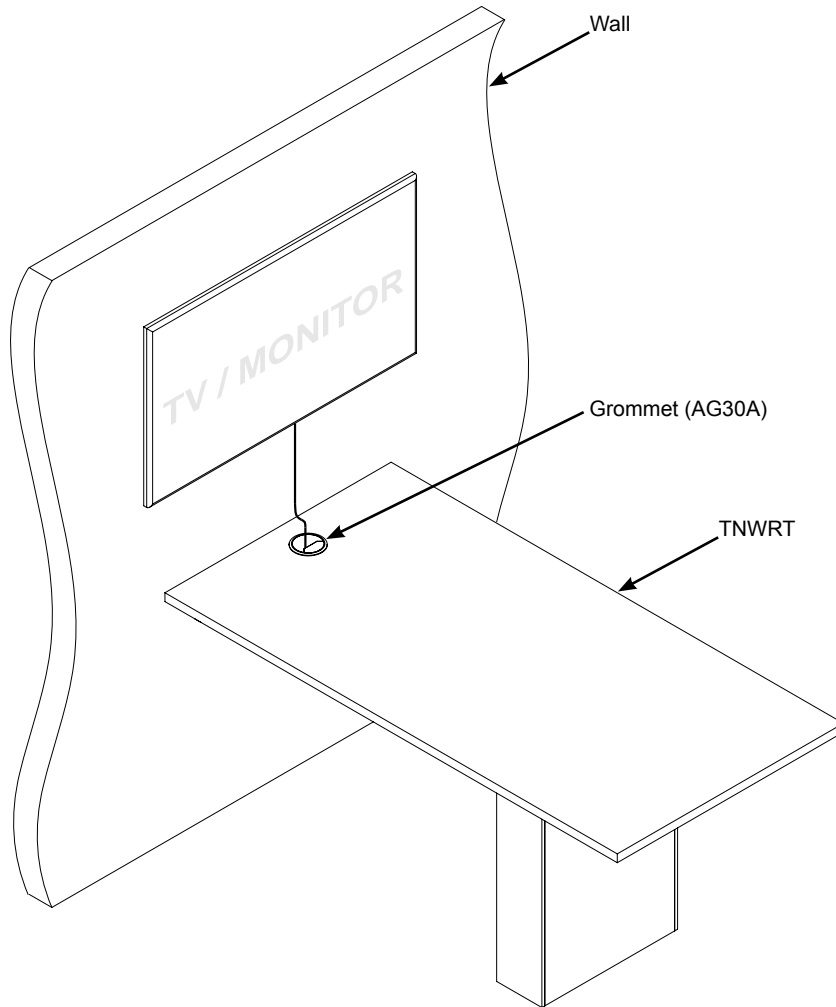

# Rectangular Fit Table - 4 Leg

TFRTT

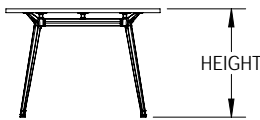
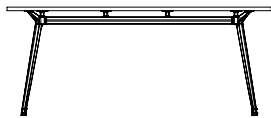
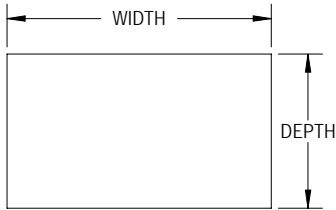
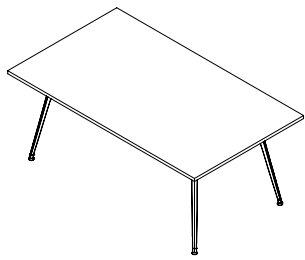

NOMINAL SIZE		TOP	POWER	LAMINATE		
WIDTH	DEPTH	SECTIONS	QUANTITY	PRICE M1	PRICE H1	PRICE K1
60"	30"	1	0	\$1,711	\$1,992	\$2,616
72"	30"	1	0	\$1,725	\$2,008	\$2,618
60"	36"	1	1	\$1,737	\$2,028	\$2,544
72"	36"	1	1	\$1,752	\$2,047	\$2,620
72"	42"	1	1	\$1,752	\$2,047	\$2,622
78"	42"	1	1	\$1,785	\$2,083	\$2,653
84"	42"	1	1	\$1,812	\$2,109	\$2,680
90"	42"	1	1	\$1,846	\$2,145	\$2,714
96"	42"	1	1	\$1,873	\$2,173	\$2,741
72"	48"	1	1	\$1,779	\$2,075	\$2,652
78"	48"	1	1	\$1,812	\$2,109	\$2,684
84"	48"	1	1	\$1,839	\$2,136	\$2,711
90"	48"	1	1	\$1,873	\$2,173	\$2,743
96"	48"	1	1	\$1,900	\$2,199	\$2,770
72"	54"	1	1	\$1,806	\$2,102	\$2,684
78"	54"	1	1	\$1,839	\$2,136	\$2,717
84"	54"	1	1	\$1,866	\$2,164	\$2,743
90"	54"	1	1	\$1,900	\$2,199	\$2,774
96"	54"	1	1	\$1,926	\$2,226	\$2,801
72"	60"	1	1	\$1,833	\$2,128	\$2,711
78"	60"	1	1	\$1,866	\$2,164	\$2,743
84"	60"	1	1	\$1,893	\$2,191	\$2,770
90"	60"	1	1	\$1,926	\$2,226	\$2,801
96"	60"	1	1	\$1,953	\$2,254	\$2,828

**ORDER CODE SAMPLE**

LINE 1	TABLE	ITEM CODE	WIDTH	DEPTH	LAMINATE	OPTION
		TFRTT	W96	D48	M1	CC
LINE 1.1	POWER & DATA	POWER OPTION	FINISH / TRIM FINISH / COVER CODE	BODY FINISH / OPTION	POWER QTY	
		AF2RE	SLV	D	1	

**Features & Specifications**

No Charge Options

Optional Extra

- Laminate codes - M1: 1" LPL, H1: 1" HPL, K1: 1.25" knife edge (top only)
- Base legs available in chrome only; upper frames are black
- Height is 29" nominal, including levellers, including levellers
- Available in all standard laminates
- For 3" curved corners add option code "CC" and \$349

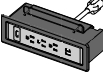
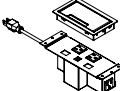
POWER & DATA	For detailed specification, cover code finishes, data and telecom options, and pricing of each electrical modules please refer to page "Power & Data Options".				
<b>AF2RE</b> 	<b>Finish:</b> Black (BLK), Silver (SLV), White (WHT), Anodized Aluminum (BAA), Stainless Steel (BSS)	<b>AF3AE</b> 	<b>Trim Finish:</b> Black (BLK), Silver (SLV), White (WHT)	<b>AU2FE</b> 	<b>Cover Code:</b> F-AL, F-S, F-B, F-W
	<b>Option (Data &amp; Telecom):</b> A, B, C, D, E, F, G, H, J, K		<b>Body Finish:</b> White (WHT), Gray (GRY), Black (BLK), Orange (ORN), Red (RED), Green (GRN), Blue (BLU)		<b>Option (Data &amp; Telecom):</b> C, K

PRODUCT MAP  
CONFERENCE TABLES  
MEDIA TABLES  
PARSONS TABLES  
MEETING & CASUAL TABLES  
NEST TRAINING TABLES  
www.brc.group

# Rectangular Fit Table - 6 Leg

TFRTT

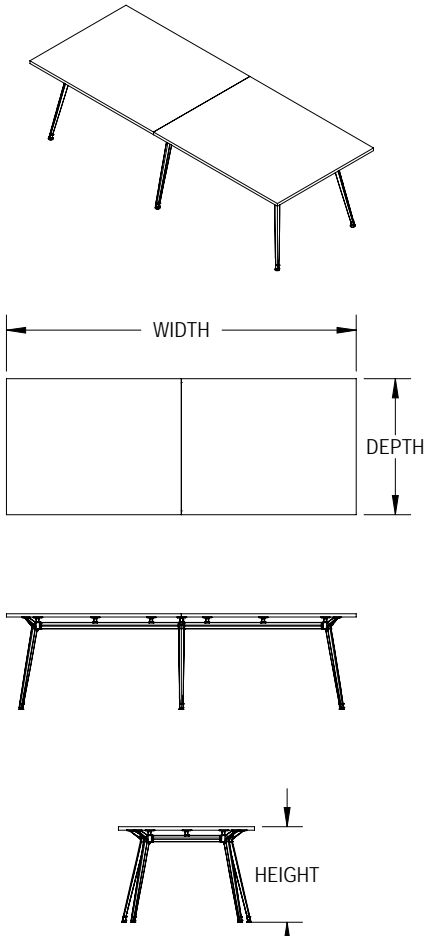

NOMINAL SIZE		TOP	POWER	LAMINATE		
WIDTH	DEPTH	SECTIONS	QUANTITY	PRICE M1	PRICE H1	PRICE K1
108"	42"	2	2	\$2,326	\$2,632	\$3,184
120"	42"	2	2	\$3,045	\$3,611	\$4,822
132"	42"	2	2	\$3,113	\$3,683	\$4,883
144"	42"	2	2	\$3,180	\$3,757	\$4,941
156"	42"	2	2	\$3,247	\$3,826	\$4,999
168"	42"	2	2	\$3,313	\$3,899	\$5,059
108"	48"	2	2	\$2,366	\$2,671	\$3,228
120"	48"	2	2	\$3,086	\$3,651	\$4,867
132"	48"	2	2	\$3,153	\$3,722	\$4,923
144"	48"	2	2	\$3,221	\$3,794	\$4,983
156"	48"	2	2	\$3,286	\$3,868	\$5,043
168"	48"	2	2	\$3,355	\$3,939	\$5,100
108"	54"	2	2	\$2,407	\$2,712	\$3,274
120"	54"	2	2	\$3,126	\$3,691	\$4,911
132"	54"	2	2	\$3,194	\$3,765	\$4,970
144"	54"	2	2	\$3,259	\$3,834	\$5,028
156"	54"	2	2	\$3,328	\$3,907	\$5,087
168"	54"	2	2	\$3,393	\$3,979	\$5,145
108"	60"	2	2	\$2,447	\$2,751	\$3,313
120"	60"	2	2	\$3,166	\$3,732	\$4,950
132"	60"	2	2	\$3,233	\$3,802	\$5,010
144"	60"	2	2	\$3,301	\$3,874	\$5,070
156"	60"	2	2	\$3,365	\$3,948	\$5,126
168"	60"	2	2	\$3,433	\$4,020	\$5,186

**ORDER CODE SAMPLE**

LINE 1	TABLE	ITEM CODE	WIDTH	DEPTH	LAMINATE	OPTION
		TFRTT	W144	D48	M1	CC
LINE 1.1	POWER & DATA	POWER OPTION	FINISH / TRIM FINISH / COVER CODE	BODY FINISH / OPTION	POWER QTY	
		AF2RE	SLV	D	2	

**Features & Specifications**

No Charge Options

Optional Extra

- Laminate codes - M1: 1" LPL, H1: 1" HPL, K1: 1.25" knife edge (top only)
- Base legs available in chrome only; upper frames are black
- Height is 29" nominal, including levellers, including levellers
- Available in all standard laminates
- For 3" curved corners add option code "CC" and \$349

**POWER & DATA** For detailed specification, cover code finishes, data and telecom options, and pricing of each electrical modules please refer to page "Power & Data Options".

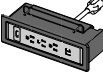
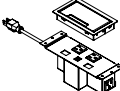
 <p><b>AF2RE</b></p>	<p><b>Finish:</b> Black (BLK), Silver (SLV), White (WHT), Anodized Aluminum (BAA), Stainless Steel (BSS)</p>	 <p><b>AF3AE</b></p>	<p><b>Trim Finish:</b> Black (BLK), Silver (SLV), White (WHT)</p>	 <p><b>AU2FE</b></p>	<p><b>Cover Code:</b> F-AL, F-S, F-B, F-W</p>
	<p><b>Option (Data &amp; Telecom):</b> A, B, C, D, E, F, G, H, J, K</p>		<p><b>Body Finish:</b> White (WHT), Gray (GRY), Black (BLK), Orange (ORN), Red (RED), Green (GRN), Blue (BLU)</p>		<p><b>Option (Data &amp; Telecom):</b> C, K</p>

# Rectangular Fit Table - 8 Leg

TFRTT

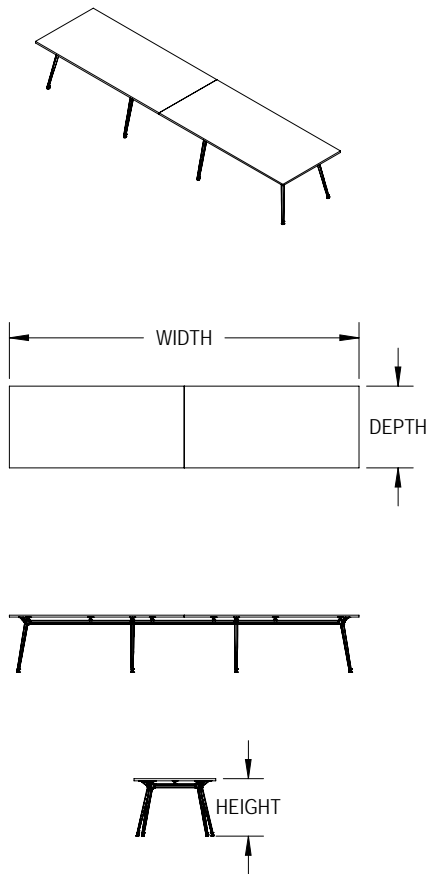

NOMINAL SIZE		TOP	POWER	LAMINATE		
WIDTH	DEPTH	SECTIONS	QUANTITY	PRICE M1	PRICE H1	PRICE K1
180"	42"	2	2	\$3,743	\$4,334	\$5,481
192"	42"	2	2	\$3,856	\$4,453	\$5,584
204"	42"	3	1, 2, 3	\$3,937	\$4,544	\$5,648
216"	42"	3	1, 2, 3	\$3,989	\$4,598	\$5,700
228"	42"	3	1, 2, 3	\$4,721	\$5,595	\$7,343
240"	42"	3	1, 2, 3	\$4,777	\$5,648	\$7,398
252"	42"	3	1, 2, 3	\$4,883	\$5,777	\$7,471
264"	42"	3	1, 2, 3	\$4,937	\$5,830	\$7,525
276"	42"	3	1, 2, 3	\$4,990	\$5,882	\$7,578
288"	42"	3	1, 2, 3	\$5,044	\$5,936	\$7,632
180"	48"	2	2	\$3,797	\$4,387	\$5,536
192"	48"	2	2	\$3,910	\$4,507	\$5,639
204"	48"	3	1, 2, 3	\$3,989	\$4,598	\$5,703
216"	48"	3	1, 2, 3	\$4,042	\$4,650	\$5,756
228"	48"	3	1, 2, 3	\$4,777	\$5,648	\$7,401
240"	48"	3	1, 2, 3	\$4,830	\$5,701	\$7,454
252"	48"	3	1, 2, 3	\$4,937	\$5,830	\$7,527
264"	48"	3	1, 2, 3	\$4,990	\$5,882	\$7,581
276"	48"	3	1, 2, 3	\$5,044	\$5,936	\$7,633
288"	48"	3	1, 2, 3	\$5,098	\$5,990	\$7,687
180"	54"	2	2	\$3,850	\$4,442	\$5,595
192"	54"	2	2	\$3,962	\$4,560	\$5,699
204"	54"	3	1, 2, 3	\$4,042	\$4,650	\$5,761
216"	54"	3	1, 2, 3	\$4,096	\$4,704	\$5,815
228"	54"	3	1, 2, 3	\$4,830	\$5,701	\$7,461
240"	54"	3	1, 2, 3	\$4,883	\$5,755	\$7,513
252"	54"	3	1, 2, 3	\$4,990	\$5,882	\$7,585
264"	54"	3	1, 2, 3	\$5,044	\$5,936	\$7,638
276"	54"	3	1, 2, 3	\$5,098	\$5,990	\$7,693
288"	54"	3	1, 2, 3	\$5,151	\$6,043	\$7,746
180"	60"	2	2	\$3,904	\$4,496	\$5,648
192"	60"	2	2	\$4,015	\$4,614	\$5,751
204"	60"	3	1, 2, 3	\$4,096	\$4,704	\$5,815
216"	60"	3	1, 2, 3	\$4,150	\$4,757	\$5,868
228"	60"	3	1, 2, 3	\$4,883	\$5,755	\$7,513
240"	60"	3	1, 2, 3	\$4,937	\$5,808	\$7,566
252"	60"	3	1, 2, 3	\$5,044	\$5,936	\$7,638
264"	60"	3	1, 2, 3	\$5,098	\$5,990	\$7,693
276"	60"	3	1, 2, 3	\$5,151	\$6,043	\$7,746
288"	60"	3	1, 2, 3	\$5,204	\$6,097	\$7,799

**ORDER CODE SAMPLE**

LINE 1	TABLE	ITEM CODE	WIDTH	DEPTH	LAMINATE	OPTION
		TFRTT	W276	D48	M1	CC
LINE 1.1	POWER & DATA	POWER OPTION	FINISH / TRIM FINISH / COVER CODE	BODY FINISH / OPTION	POWER QTY	
		AF2RE	SLV	D	1	

**Features & Specifications**

No Charge Options

Optional Extra

- Laminate codes - M1: 1" LPL, H1: 1" HPL, K1: 1.25" knife edge (top only)
- Base legs available in chrome only; upper frames are black
- Height is 29" nominal, including levellers, including levellers
- Available in all standard laminates
- For 3" curved corners add option code "CC" and \$349

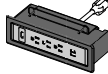
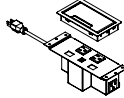
POWER & DATA	For detailed specification, cover code finishes, data and telecom options, and pricing of each electrical modules please refer to page "Power & Data Options".				
<b>AF2RE</b> 	<b>Finish:</b> Black (BLK), Silver (SLV), White (WHT), Anodized Aluminum (BAA), Stainless Steel (BSS)	<b>AF3AE</b> 	<b>Trim Finish:</b> Black (BLK), Silver (SLV), White (WHT)	<b>AU2FE</b> 	<b>Cover Code:</b> F-AL, F-S, F-B, F-W
	<b>Option (Data &amp; Telecom):</b> A, B, C, D, E, F, G, H, J, K		<b>Body Finish:</b> White (WHT), Gray (GRY), Black (BLK), Orange (ORN), Red (RED), Green (GRN), Blue (BLU)		<b>Option (Data &amp; Telecom):</b> C, K

# Boat Shape Fit Table - 4 Leg

TFACT

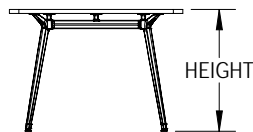
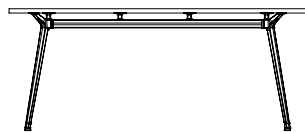
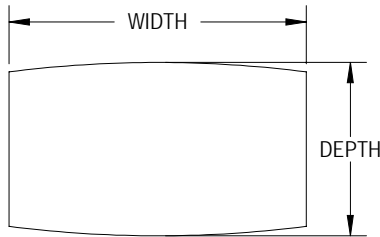
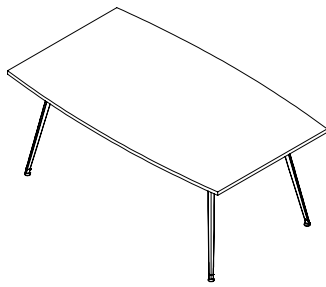

NOMINAL SIZE		TOP	POWER	LAMINATE		
WIDTH	DEPTH	SECTIONS	QUANTITY	PRICE M1	PRICE H1	PRICE K1
60"	30"	1	0	\$1,822	\$2,161	\$2,777
72"	30"	1	0	\$1,824	\$2,162	\$2,780
60"	36"	1	1	\$1,812	\$2,132	\$2,699
72"	36"	1	1	\$1,826	\$2,164	\$2,782
72"	42"	1	1	\$1,828	\$2,165	\$2,785
78"	42"	1	1	\$1,859	\$2,195	\$2,819
84"	42"	1	1	\$1,885	\$2,222	\$2,845
90"	42"	1	1	\$1,914	\$2,252	\$2,877
96"	42"	1	1	\$1,941	\$2,279	\$2,903
72"	48"	1	1	\$1,855	\$2,194	\$2,814
78"	48"	1	1	\$1,886	\$2,224	\$2,848
84"	48"	1	1	\$1,913	\$2,250	\$2,874
90"	48"	1	1	\$1,943	\$2,280	\$2,906
96"	48"	1	1	\$1,970	\$2,307	\$2,933
72"	54"	1	1	\$1,886	\$2,224	\$2,848
78"	54"	1	1	\$1,915	\$2,256	\$2,879
84"	54"	1	1	\$1,943	\$2,280	\$2,906
90"	54"	1	1	\$1,974	\$2,312	\$2,939
96"	54"	1	1	\$2,001	\$2,338	\$2,965
72"	60"	1	1	\$1,913	\$2,250	\$2,874
78"	60"	1	1	\$1,943	\$2,280	\$2,906
84"	60"	1	1	\$1,970	\$2,307	\$2,933
90"	60"	1	1	\$2,001	\$2,338	\$2,965
96"	60"	1	1	\$2,027	\$2,365	\$2,992

**ORDER CODE SAMPLE**

LINE 1	TABLE	ITEM CODE	WIDTH	DEPTH	LAMINATE	OPTION
		TFACT	W96	D48	M1	CC
LINE 1.1	POWER & DATA	POWER OPTION	FINISH / TRIM FINISH / COVER CODE	BODY FINISH / OPTION	POWER QTY	
		AF2RE	SLV	D	1	

**Features & Specifications**

No Charge Options

Optional Extra

- Laminate codes - M1: 1" LPL, H1: 1" HPL, K1: 1.25" knife edge (top only)
- Base legs available in chrome only; upper frames are black
- Height is 29" nominal, including levellers, including levellers
- Available in all standard laminates
- For 3" curved corners add option code "CC" and \$349

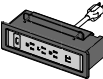
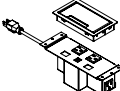
POWER & DATA	For detailed specification, cover code finishes, data and telecom options, and pricing of each electrical modules please refer to page "Power & Data Options".				
<b>AF2RE</b> 	<b>Finish:</b> Black (BLK), Silver (SLV), White (WHT), Anodized Aluminum (BAA), Stainless Steel (BSS)	<b>AF3AE</b> 	<b>Trim Finish:</b> Black (BLK), Silver (SLV), White (WHT)	<b>AU2FE</b> 	<b>Cover Code:</b> F-AL, F-S, F-B, F-W
	<b>Option (Data &amp; Telecom):</b> A, B, C, D, E, F, G, H, J, K		<b>Body Finish:</b> White (WHT), Gray (GRY), Black (BLK), Orange (ORN), Red (RED), Green (GRN), Blue (BLU)		<b>Option (Data &amp; Telecom):</b> C, K

# Boat Shape Fit Table - 6 Leg

TFACT

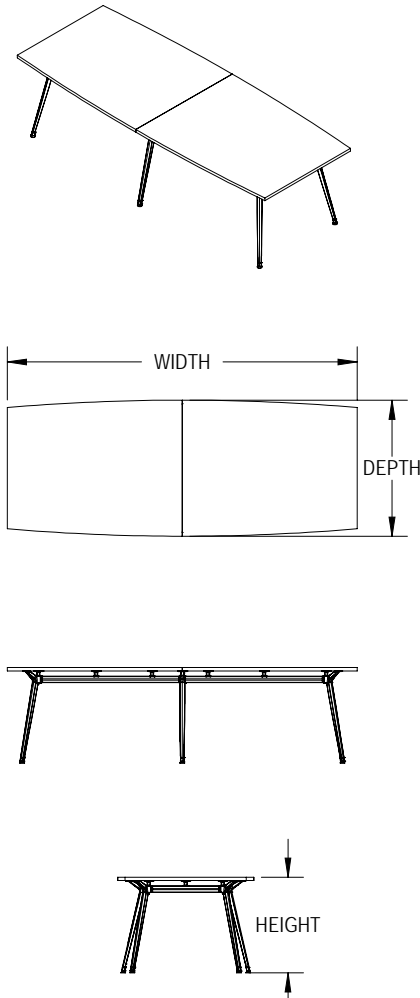

NOMINAL SIZE		TOP	POWER	LAMINATE		
WIDTH	DEPTH	SECTIONS	QUANTITY	PRICE M1	PRICE H1	PRICE K1
108"	42"	2	2	\$2,385	\$2,722	\$3,349
120"	42"	2	2	\$3,242	\$3,919	\$5,146
132"	42"	2	2	\$3,298	\$3,975	\$5,205
144"	42"	2	2	\$3,357	\$4,032	\$5,265
156"	42"	2	2	\$3,413	\$4,089	\$5,324
168"	42"	2	2	\$3,470	\$4,145	\$5,382
108"	48"	2	2	\$2,426	\$2,766	\$3,393
120"	48"	2	2	\$3,284	\$3,960	\$5,190
132"	48"	2	2	\$3,339	\$4,016	\$5,249
144"	48"	2	2	\$3,398	\$4,073	\$5,306
156"	48"	2	2	\$3,454	\$4,131	\$5,367
168"	48"	2	2	\$3,511	\$4,187	\$5,425
108"	54"	2	2	\$2,469	\$2,808	\$3,438
120"	54"	2	2	\$3,328	\$4,003	\$5,236
132"	54"	2	2	\$3,385	\$4,060	\$5,294
144"	54"	2	2	\$3,440	\$4,117	\$5,353
156"	54"	2	2	\$3,498	\$4,174	\$5,411
168"	54"	2	2	\$3,555	\$4,230	\$5,472
108"	60"	2	2	\$2,510	\$2,849	\$3,478
120"	60"	2	2	\$3,367	\$4,043	\$5,275
132"	60"	2	2	\$3,425	\$4,100	\$5,333
144"	60"	2	2	\$3,480	\$4,157	\$5,394
156"	60"	2	2	\$3,538	\$4,215	\$5,453
168"	60"	2	2	\$3,595	\$4,271	\$5,511

**ORDER CODE SAMPLE**

LINE 1	TABLE	ITEM CODE	WIDTH	DEPTH	LAMINATE	OPTION
		TFACT	W144	D48	M1	CC
LINE 1.1	POWER & DATA	POWER OPTION	FINISH / TRIM FINISH / COVER CODE	BODY FINISH / OPTION	POWER QTY	
		AF2RE	SLV	D	2	

**Features & Specifications**

No Charge Options

Optional Extra

- Laminate codes - M1: 1" LPL, H1: 1" HPL, K1: 1.25" knife edge (top only)
- Base legs available in chrome only; upper frames are black
- Height is 29" nominal, including levellers, including levellers
- Available in all standard laminates
- For 3" curved corners add option code "CC" and \$349

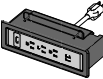
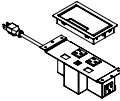
POWER & DATA	For detailed specification, cover code finishes, data and telecom options, and pricing of each electrical modules please refer to page "Power & Data Options".				
<b>AF2RE</b> 	<b>Finish:</b> Black (BLK), Silver (SLV), White (WHT), Anodized Aluminum (BAA), Stainless Steel (BSS)	<b>AF3AE</b> 	<b>Trim Finish:</b> Black (BLK), Silver (SLV), White (WHT)	<b>AU2FE</b> 	<b>Cover Code:</b> F-AL, F-S, F-B, F-W
	<b>Option (Data &amp; Telecom):</b> A, B, C, D, E, F, G, H, J, K		<b>Body Finish:</b> White (WHT), Gray (GRY), Black (BLK), Orange (ORN), Red (RED), Green (GRN), Blue (BLU)		<b>Option (Data &amp; Telecom):</b> C, K

PRODUCT MAP  
CONFERENCE TABLES  
MEDIA TABLES  
PARSONS TABLES  
MEETING & CASUAL TABLES  
NEST TRAINING TABLES  
www.brc.group

# Boat Shape Fit Table - 8 Leg

TFACT

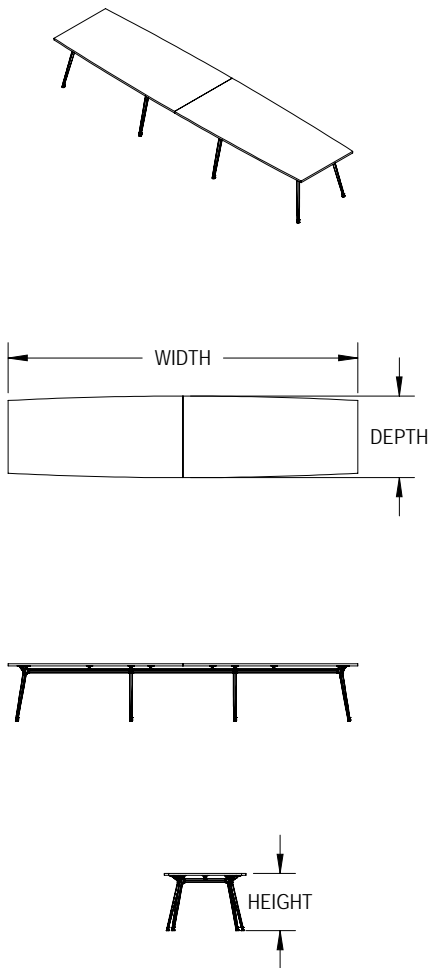

NOMINAL SIZE		TOP	POWER	LAMINATE		
WIDTH	DEPTH	SECTIONS	QUANTITY	PRICE M1	PRICE H1	PRICE K1
180"	42"	2	2	\$3,890	\$4,566	\$5,806
192"	42"	2	2	\$3,992	\$4,668	\$5,909
204"	42"	3	1, 2, 3	\$4,052	\$4,729	\$5,972
216"	42"	3	1, 2, 3	\$4,105	\$4,782	\$6,028
228"	42"	3	1, 2, 3	\$4,968	\$5,981	\$7,830
240"	42"	3	1, 2, 3	\$5,021	\$6,034	\$7,885
252"	42"	3	1, 2, 3	\$5,088	\$6,100	\$7,958
264"	42"	3	1, 2, 3	\$5,141	\$6,154	\$8,012
276"	42"	3	1, 2, 3	\$5,194	\$6,209	\$8,066
288"	42"	3	1, 2, 3	\$5,247	\$6,262	\$8,120
180"	48"	2	2	\$3,947	\$4,621	\$5,862
192"	48"	2	2	\$4,048	\$4,724	\$5,966
204"	48"	3	1, 2, 3	\$4,109	\$4,783	\$6,030
216"	48"	3	1, 2, 3	\$4,162	\$4,838	\$6,083
228"	48"	3	1, 2, 3	\$5,022	\$6,037	\$7,887
240"	48"	3	1, 2, 3	\$5,075	\$6,090	\$7,941
252"	48"	3	1, 2, 3	\$5,142	\$6,157	\$8,015
264"	48"	3	1, 2, 3	\$5,196	\$6,210	\$8,069
276"	48"	3	1, 2, 3	\$5,250	\$6,263	\$8,122
288"	48"	3	1, 2, 3	\$5,303	\$6,316	\$8,176
180"	54"	2	2	\$4,002	\$4,678	\$5,920
192"	54"	2	2	\$4,104	\$4,780	\$6,023
204"	54"	3	1, 2, 3	\$4,165	\$4,840	\$6,089
216"	54"	3	1, 2, 3	\$4,218	\$4,893	\$6,143
228"	54"	3	1, 2, 3	\$5,079	\$6,093	\$7,947
240"	54"	3	1, 2, 3	\$5,131	\$6,147	\$8,000
252"	54"	3	1, 2, 3	\$5,199	\$6,213	\$8,076
264"	54"	3	1, 2, 3	\$5,252	\$6,266	\$8,129
276"	54"	3	1, 2, 3	\$5,305	\$6,320	\$8,182
288"	54"	3	1, 2, 3	\$5,358	\$6,374	\$8,236
180"	60"	2	2	\$4,055	\$4,731	\$5,973
192"	60"	2	2	\$4,157	\$4,833	\$6,078
204"	60"	3	1, 2, 3	\$4,218	\$4,893	\$6,143
216"	60"	3	1, 2, 3	\$4,272	\$4,947	\$6,197
228"	60"	3	1, 2, 3	\$5,131	\$6,147	\$8,000
240"	60"	3	1, 2, 3	\$5,186	\$6,200	\$8,052
252"	60"	3	1, 2, 3	\$5,252	\$6,266	\$8,129
264"	60"	3	1, 2, 3	\$5,305	\$6,320	\$8,182
276"	60"	3	1, 2, 3	\$5,358	\$6,374	\$8,236
288"	60"	3	1, 2, 3	\$5,412	\$6,426	\$8,289

**ORDER CODE SAMPLE**

LINE 1	TABLE	ITEM CODE	WIDTH	DEPTH	LAMINATE	OPTION
		TFACT	W276	D48	M1	CC
LINE 1.1	POWER & DATA	POWER OPTION	FINISH / TRIM FINISH / COVER CODE	BODY FINISH / OPTION	POWER QTY	
		AF2RE	SLV	D	1	

**Features & Specifications**

No Charge Options

Optional Extra

- Laminate codes - M1: 1" LPL, H1: 1" HPL, K1: 1.25" knife edge (top only)
- Base legs available in chrome only; upper frames are black
- Height is 29" nominal, including levellers, including levellers
- Available in all standard laminates
- For 3" curved corners add option code "CC" and \$349

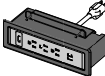
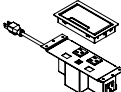
POWER & DATA					
For detailed specification, cover code finishes, data and telecom options, and pricing of each electrical modules please refer to page "Power & Data Options".					
 <b>AF2RE</b>	<b>Finish:</b> Black (BLK), Silver (SLV), White (WHT), Anodized Aluminum (BAA), Stainless Steel (BSS)	 <b>AF3AE</b>	<b>Trim Finish:</b> Black (BLK), Silver (SLV), White (WHT)	 <b>AU2FE</b>	<b>Cover Code:</b> F-AL, F-S, F-B, F-W
	<b>Option (Data &amp; Telecom):</b> A, B, C, D, E, F, G, H, J, K		<b>Body Finish:</b> White (WHT), Gray (GRY), Black (BLK), Orange (ORN), Red (RED), Green (GRN), Blue (BLU)		<b>Option (Data &amp; Telecom):</b> C, K

PRODUCT MAP  
CONFERENCE TABLES  
MEDIA TABLES  
PARSONS TABLES  
MEETING & CASUAL TABLES  
NEST TRAINING TABLES  
www.brc.group

# Racetrack Fit Table - 4 Leg

TFRCT

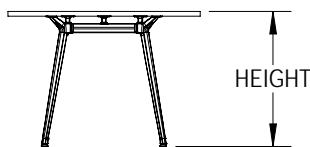
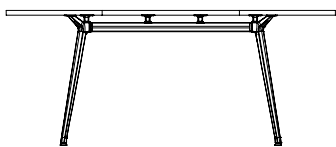
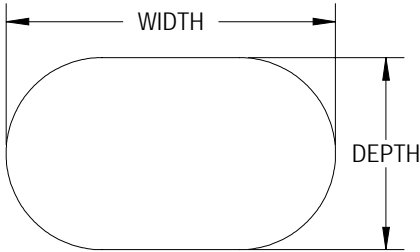
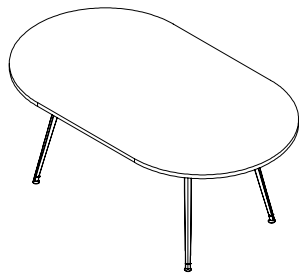

NOMINAL SIZE		TOP	POWER	LAMINATE		
WIDTH	DEPTH	SECTIONS	QUANTITY	PRICE M1	PRICE H1	PRICE K1
60"	30"	1	0	\$1,721	\$2,057	\$2,674
72"	30"	1	0	\$1,722	\$2,058	\$2,678
60"	36"	1	1	\$1,709	\$2,028	\$2,596
72"	36"	1	1	\$1,724	\$2,062	\$2,680
72"	42"	1	1	\$1,680	\$2,017	\$2,639
78"	42"	1	1	\$1,710	\$2,050	\$2,670
84"	42"	1	1	\$1,782	\$2,118	\$2,743
90"	42"	1	1	\$1,812	\$2,152	\$2,774
96"	42"	1	1	\$1,839	\$2,178	\$2,801
72"	48"	1	1	\$1,708	\$2,046	\$2,668
78"	48"	1	1	\$1,739	\$2,077	\$2,699
84"	48"	1	1	\$1,810	\$2,148	\$2,772
90"	48"	1	1	\$1,841	\$2,179	\$2,804
96"	48"	1	1	\$1,868	\$2,206	\$2,831
72"	54"	1	1	\$1,739	\$2,077	\$2,699
78"	54"	1	1	\$1,769	\$2,106	\$2,731
84"	54"	1	1	\$1,841	\$2,179	\$2,804
90"	54"	1	1	\$1,871	\$2,208	\$2,837
96"	54"	1	1	\$1,897	\$2,235	\$2,863
72"	60"	1	1	\$1,765	\$2,104	\$2,726
78"	60"	1	1	\$1,795	\$2,133	\$2,758
84"	60"	1	1	\$1,868	\$2,206	\$2,831
90"	60"	1	1	\$1,897	\$2,235	\$2,863
96"	60"	1	1	\$1,924	\$2,262	\$2,890

**ORDER CODE SAMPLE**

LINE 1	TABLE	ITEM CODE	WIDTH	DEPTH	LAMINATE
		TFRCT	W96	D48	M1
LINE 1.1	POWER & DATA	POWER OPTION	FINISH / TRIM FINISH / COVER CODE	BODY FINISH / OPTION	POWER QTY
		AF2RE	SLV	D	1

**Features & Specifications**

No Charge Options

- Laminate codes - M1: 1" LPL, H1: 1" HPL, K1: 1.25" knife edge (top only)
- Base legs available in chrome only; upper frames are black
- Height is 29" nominal, including levellers, including levellers
- Available in all standard laminates

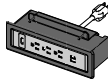
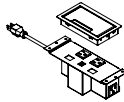
POWER & DATA	For detailed specification, cover code finishes, data and telecom options, and pricing of each electrical modules please refer to page "Power & Data Options".				
<b>AF2RE</b> 	<b>Finish:</b> Black (BLK), Silver (SLV), White (WHT), Anodized Aluminum (BAA), Stainless Steel (BSS)	<b>AF3AE</b> 	<b>Trim Finish:</b> Black (BLK), Silver (SLV), White (WHT)	<b>AU2FE</b> 	<b>Cover Code:</b> F-AL, F-S, F-B, F-W
	<b>Option (Data &amp; Telecom):</b> A, B, C, D, E, F, G, H, J, K		<b>Body Finish:</b> White (WHT), Gray (GRY), Black (BLK), Orange (ORN), Red (RED), Green (GRN), Blue (BLU)		<b>Option (Data &amp; Telecom):</b> C, K

PRODUCT MAP  
CONFERENCE TABLES  
MEDIA TABLES  
PARSONS TABLES  
MEETING & CASUAL TABLES  
NEST TRAINING TABLES  
www.brc.group

# Racetrack Fit Table - 6 Leg

TFRCT

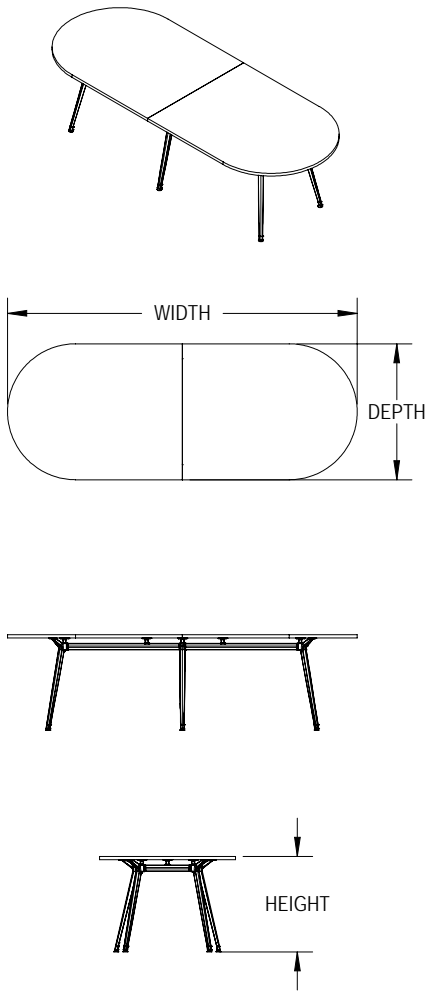

NOMINAL SIZE		TOP	POWER	LAMINATE		
WIDTH	DEPTH	SECTIONS	QUANTITY	PRICE M1	PRICE H1	PRICE K1
108"	42"	2	2	\$2,220	\$2,559	\$3,185
120"	42"	2	2	\$3,079	\$3,753	\$4,983
132"	42"	2	2	\$3,134	\$3,812	\$5,043
144"	42"	2	2	\$3,194	\$3,869	\$5,101
156"	42"	2	2	\$3,294	\$3,971	\$5,205
168"	42"	2	2	\$3,350	\$4,028	\$5,265
108"	48"	2	2	\$2,263	\$2,600	\$3,229
120"	48"	2	2	\$3,121	\$3,797	\$5,025
132"	48"	2	2	\$3,178	\$3,853	\$5,085
144"	48"	2	2	\$3,234	\$3,910	\$5,143
156"	48"	2	2	\$3,336	\$4,013	\$5,249
168"	48"	2	2	\$3,394	\$4,069	\$5,306
108"	54"	2	2	\$2,307	\$2,645	\$3,275
120"	54"	2	2	\$3,164	\$3,841	\$5,072
132"	54"	2	2	\$3,222	\$3,897	\$5,130
144"	54"	2	2	\$3,279	\$3,953	\$5,190
156"	54"	2	2	\$3,382	\$4,055	\$5,294
168"	54"	2	2	\$3,437	\$4,113	\$5,353
108"	60"	2	2	\$2,302	\$2,641	\$3,271
120"	60"	2	2	\$3,158	\$3,837	\$5,067
132"	60"	2	2	\$3,216	\$3,893	\$5,126
144"	60"	2	2	\$3,274	\$3,950	\$5,186
156"	60"	2	2	\$3,375	\$4,052	\$5,291
168"	60"	2	2	\$3,433	\$4,109	\$5,348

**ORDER CODE SAMPLE**

LINE 1	TABLE	ITEM CODE	WIDTH	DEPTH	LAMINATE
		TFRCT	W144	D48	M1
LINE 1.1	POWER & DATA	POWER OPTION	FINISH / TRIM FINISH / COVER CODE	BODY FINISH / OPTION	POWER QTY
		AF2RE	SLV	D	2

**Features & Specifications**

No Charge Options

- Laminate codes - M1: 1" LPL, H1: 1" HPL, K1: 1.25" knife edge (top only)
- Base legs available in chrome only; upper frames are black
- Height is 29" nominal, including levellers, including levellers
- Available in all standard laminates

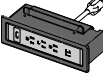
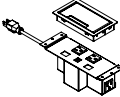
POWER & DATA	For detailed specification, cover code finishes, data and telecom options, and pricing of each electrical modules please refer to page "Power & Data Options".				
<b>AF2RE</b> 	<b>Finish:</b> Black (BLK), Silver (SLV), White (WHT), Anodized Aluminum (BAA), Stainless Steel (BSS)	<b>AF3AE</b> 	<b>Trim Finish:</b> Black (BLK), Silver (SLV), White (WHT)	<b>AU2FE</b> 	<b>Cover Code:</b> F-AL, F-S, F-B, F-W
	<b>Option (Data &amp; Telecom):</b> A, B, C, D, E, F, G, H, J, K		<b>Body Finish:</b> White (WHT), Gray (GRY), Black (BLK), Orange (ORN), Red (RED), Green (GRN), Blue (BLU)		<b>Option (Data &amp; Telecom):</b> C, K

PRODUCT MAP  
CONFERENCE TABLES  
MEDIA TABLES  
PARSONS TABLES  
MEETING & CASUAL TABLES  
NEST TRAINING TABLES  
www.brc.group

# Racetrack Fit Table - 8 Leg

TFRCT

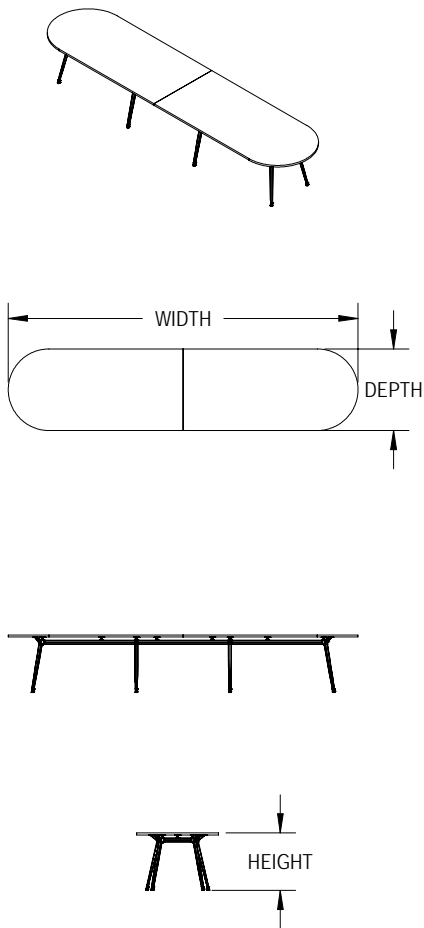

NOMINAL SIZE		TOP	POWER	LAMINATE		
WIDTH	DEPTH	SECTIONS	QUANTITY	PRICE M1	PRICE H1	PRICE K1
180"	42"	2	2	\$3,758	\$4,433	\$5,673
192"	42"	2	2	\$3,814	\$4,488	\$5,730
204"	42"	3	1, 2, 3	\$3,873	\$4,549	\$5,795
216"	42"	3	1, 2, 3	\$3,973	\$4,649	\$5,893
228"	42"	3	1, 2, 3	\$4,833	\$5,849	\$7,697
240"	42"	3	1, 2, 3	\$4,887	\$5,902	\$7,751
252"	42"	3	1, 2, 3	\$4,953	\$5,968	\$7,825
264"	42"	3	1, 2, 3	\$5,008	\$6,020	\$7,878
276"	42"	3	1, 2, 3	\$5,061	\$6,073	\$7,931
288"	42"	3	1, 2, 3	\$5,114	\$6,127	\$7,986
180"	48"	2	2	\$3,812	\$4,487	\$5,728
192"	48"	2	2	\$3,869	\$4,545	\$5,787
204"	48"	3	1, 2, 3	\$3,928	\$4,605	\$5,852
216"	48"	3	1, 2, 3	\$4,028	\$4,704	\$5,951
228"	48"	3	1, 2, 3	\$4,888	\$5,903	\$7,753
240"	48"	3	1, 2, 3	\$4,942	\$5,957	\$7,807
252"	48"	3	1, 2, 3	\$5,009	\$6,022	\$7,880
264"	48"	3	1, 2, 3	\$5,062	\$6,076	\$7,935
276"	48"	3	1, 2, 3	\$5,115	\$6,129	\$7,988
288"	48"	3	1, 2, 3	\$5,169	\$6,183	\$8,041
180"	54"	2	2	\$3,869	\$4,545	\$5,787
192"	54"	2	2	\$3,880	\$4,557	\$5,802
204"	54"	3	1, 2, 3	\$3,940	\$4,617	\$5,866
216"	54"	3	1, 2, 3	\$4,040	\$4,715	\$5,965
228"	54"	3	1, 2, 3	\$4,899	\$5,915	\$7,768
240"	54"	3	1, 2, 3	\$4,953	\$5,968	\$7,822
252"	54"	3	1, 2, 3	\$5,021	\$6,036	\$7,897
264"	54"	3	1, 2, 3	\$5,074	\$6,089	\$7,950
276"	54"	3	1, 2, 3	\$5,128	\$6,143	\$8,004
288"	54"	3	1, 2, 3	\$5,181	\$6,197	\$8,057
180"	60"	2	2	\$3,877	\$4,553	\$5,795
192"	60"	2	2	\$3,934	\$4,610	\$5,855
204"	60"	3	1, 2, 3	\$3,994	\$4,670	\$5,919
216"	60"	3	1, 2, 3	\$4,093	\$4,768	\$6,018
228"	60"	3	1, 2, 3	\$4,953	\$5,968	\$7,822
240"	60"	3	1, 2, 3	\$5,008	\$6,021	\$7,874
252"	60"	3	1, 2, 3	\$5,074	\$6,089	\$7,950
264"	60"	3	1, 2, 3	\$5,128	\$6,143	\$8,004
276"	60"	3	1, 2, 3	\$5,181	\$6,197	\$8,057
288"	60"	3	1, 2, 3	\$5,236	\$6,249	\$8,110

**ORDER CODE SAMPLE**

LINE 1	TABLE	ITEM CODE	WIDTH	DEPTH	LAMINATE
		TFRCT	W276	D48	M1
LINE 1.1	POWER & DATA	POWER OPTION	FINISH / TRIM FINISH / COVER CODE	BODY FINISH / OPTION	POWER QTY
		AF2RE	SLV	D	1

**Features & Specifications**

No Charge Options

- Laminate codes - M1: 1" LPL, H1: 1" HPL, K1: 1.25" knife edge (top only)
- Base legs available in chrome only; upper frames are black
- Height is 29" nominal, including levellers, including levellers
- Available in all standard laminates

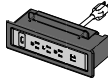
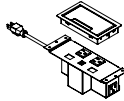
POWER & DATA					
For detailed specification, cover code finishes, data and telecom options, and pricing of each electrical modules please refer to page "Power & Data Options".					
<b>AF2RE</b> 	<b>Finish:</b> Black (BLK), Silver (SLV), White (WHT), Anodized Aluminum (BAA), Stainless Steel (BSS)	<b>AF3AE</b> 	<b>Trim Finish:</b> Black (BLK), Silver (SLV), White (WHT)	<b>AU2FE</b> 	<b>Cover Code:</b> F-AL, F-S, F-B, F-W
	<b>Option (Data &amp; Telecom):</b> A, B, C, D, E, F, G, H, J, K		<b>Body Finish:</b> White (WHT), Gray (GRY), Black (BLK), Orange (ORN), Red (RED), Green (GRN), Blue (BLU)		<b>Option (Data &amp; Telecom):</b> C, K

PRODUCT MAP  
CONFERENCE TABLES  
MEDIA TABLES  
PARSONS TABLES  
MEETING & CASUAL TABLES  
NEST TRAINING TABLES  
www.brc.group

# Arced Boat Fit Table - 4 Leg

TFBAT

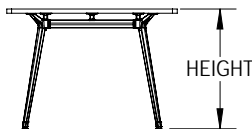
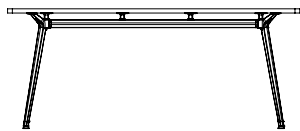
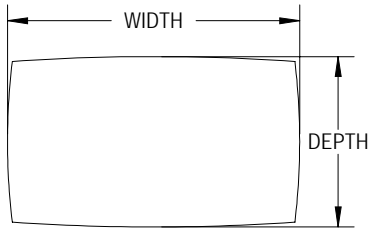
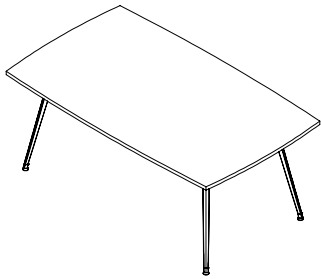

NOMINAL SIZE		TOP	POWER	LAMINATE		
WIDTH	DEPTH	SECTIONS	QUANTITY	PRICE M1	PRICE H1	PRICE K1
60"	30"	1	0	\$1,822	\$2,161	\$2,777
72"	30"	1	0	\$1,824	\$2,162	\$2,780
60"	36"	1	1	\$1,812	\$2,132	\$2,699
72"	36"	1	1	\$1,826	\$2,164	\$2,782
72"	42"	1	1	\$1,828	\$2,165	\$2,785
78"	42"	1	1	\$1,859	\$2,195	\$2,819
84"	42"	1	1	\$1,885	\$2,222	\$2,845
90"	42"	1	1	\$1,914	\$2,252	\$2,877
96"	42"	1	1	\$1,941	\$2,279	\$2,903
72"	48"	1	1	\$1,855	\$2,194	\$2,814
78"	48"	1	1	\$1,886	\$2,224	\$2,848
84"	48"	1	1	\$1,913	\$2,250	\$2,874
90"	48"	1	1	\$1,943	\$2,280	\$2,906
96"	48"	1	1	\$1,970	\$2,307	\$2,933
72"	54"	1	1	\$1,886	\$2,224	\$2,848
78"	54"	1	1	\$1,915	\$2,256	\$2,879
84"	54"	1	1	\$1,943	\$2,280	\$2,906
90"	54"	1	1	\$1,974	\$2,312	\$2,939
96"	54"	1	1	\$2,001	\$2,338	\$2,965
72"	60"	1	1	\$1,913	\$2,250	\$2,874
78"	60"	1	1	\$1,943	\$2,280	\$2,906
84"	60"	1	1	\$1,970	\$2,307	\$2,933
90"	60"	1	1	\$2,001	\$2,338	\$2,965
96"	60"	1	1	\$2,027	\$2,365	\$2,992

**ORDER CODE SAMPLE**

LINE 1	TABLE	ITEM CODE	WIDTH	DEPTH	LAMINATE	OPTION
		TFBAT	W96	D48	M1	CC
LINE 1.1	POWER & DATA	POWER OPTION	FINISH / TRIM FINISH / COVER CODE	BODY FINISH / OPTION	POWER QTY	
		AF2RE	SLV	D	1	

**Features & Specifications**

No Charge Options

Optional Extra

- Laminate codes - M1: 1" LPL, H1: 1" HPL, K1: 1.25" knife edge (top only)
- Base legs available in chrome only; upper frames are black
- Height is 29" nominal, including levellers, including levellers
- Available in all standard laminates
- For 3" curved corners add option code "CC" and \$349

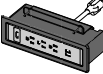
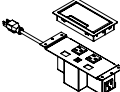
POWER & DATA	For detailed specification, cover code finishes, data and telecom options, and pricing of each electrical modules please refer to page "Power & Data Options".				
<b>AF2RE</b> 	<b>Finish:</b> Black (BLK), Silver (SLV), White (WHT), Anodized Aluminum (BAA), Stainless Steel (BSS)	<b>AF3AE</b> 	<b>Trim Finish:</b> Black (BLK), Silver (SLV), White (WHT)	<b>AU2FE</b> 	<b>Cover Code:</b> F-AL, F-S, F-B, F-W
	<b>Option (Data &amp; Telecom):</b> A, B, C, D, E, F, G, H, J, K		<b>Body Finish:</b> White (WHT), Gray (GRY), Black (BLK), Orange (ORN), Red (RED), Green (GRN), Blue (BLU)		<b>Option (Data &amp; Telecom):</b> C, K

# Arced Boat Fit Table - 6 Leg

TFBAT

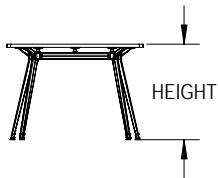
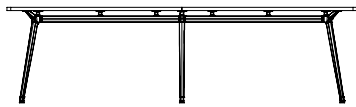
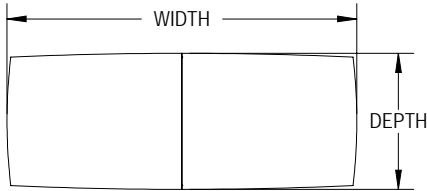
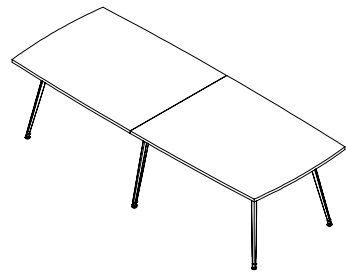

NOMINAL SIZE		TOP	POWER	LAMINATE		
WIDTH	DEPTH	SECTIONS	QUANTITY	PRICE M1	PRICE H1	PRICE K1
108"	42"	2	2	\$2,385	\$2,722	\$3,349
120"	42"	2	2	\$3,242	\$3,919	\$5,146
132"	42"	2	2	\$3,298	\$3,975	\$5,205
144"	42"	2	2	\$3,357	\$4,032	\$5,265
156"	42"	2	2	\$3,413	\$4,089	\$5,324
168"	42"	2	2	\$3,470	\$4,145	\$5,382
108"	48"	2	2	\$2,426	\$2,766	\$3,393
120"	48"	2	2	\$3,284	\$3,960	\$5,190
132"	48"	2	2	\$3,339	\$4,016	\$5,249
144"	48"	2	2	\$3,398	\$4,073	\$5,306
156"	48"	2	2	\$3,454	\$4,131	\$5,367
168"	48"	2	2	\$3,511	\$4,187	\$5,425
108"	54"	2	2	\$2,469	\$2,808	\$3,438
120"	54"	2	2	\$3,328	\$4,003	\$5,236
132"	54"	2	2	\$3,385	\$4,060	\$5,294
144"	54"	2	2	\$3,440	\$4,117	\$5,353
156"	54"	2	2	\$3,498	\$4,174	\$5,411
168"	54"	2	2	\$3,555	\$4,230	\$5,472
108"	60"	2	2	\$2,510	\$2,849	\$3,478
120"	60"	2	2	\$3,367	\$4,043	\$5,275
132"	60"	2	2	\$3,425	\$4,100	\$5,333
144"	60"	2	2	\$3,480	\$4,157	\$5,394
156"	60"	2	2	\$3,538	\$4,215	\$5,453
168"	60"	2	2	\$3,595	\$4,271	\$5,511

**ORDER CODE SAMPLE**

LINE 1	TABLE	ITEM CODE	WIDTH	DEPTH	LAMINATE	OPTION
		TFBAT	W144	D48	M1	CC
LINE 1.1	POWER & DATA	POWER OPTION	FINISH / TRIM FINISH / COVER CODE	BODY FINISH / OPTION	POWER QTY	
		AF2RE	SLV	D	2	

**Features & Specifications**

No Charge Options

Optional Extra

- Laminate codes - M1: 1" LPL, H1: 1" HPL, K1: 1.25" knife edge (top only)
- Base legs available in chrome only; upper frames are black
- Height is 29" nominal, including levellers, including levellers
- Available in all standard laminates
- For 3" curved corners add option code "CC" and \$349

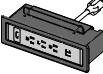
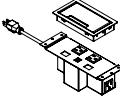
POWER & DATA	For detailed specification, cover code finishes, data and telecom options, and pricing of each electrical modules please refer to page "Power & Data Options".				
<b>AF2RE</b> 	<b>Finish:</b> Black (BLK), Silver (SLV), White (WHT), Anodized Aluminum (BAA), Stainless Steel (BSS)	<b>AF3AE</b> 	<b>Trim Finish:</b> Black (BLK), Silver (SLV), White (WHT)	<b>AU2FE</b> 	<b>Cover Code:</b> F-AL, F-S, F-B, F-W
	<b>Option (Data &amp; Telecom):</b> A, B, C, D, E, F, G, H, J, K		<b>Body Finish:</b> White (WHT), Gray (GRY), Black (BLK), Orange (ORN), Red (RED), Green (GRN), Blue (BLU)		<b>Option (Data &amp; Telecom):</b> C, K

# Arced Boat Fit Table - 8 Leg

TFBAT

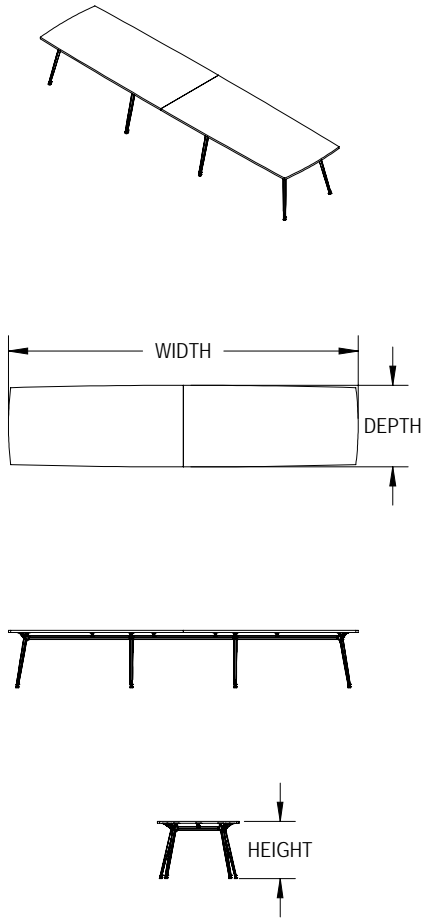

NOMINAL SIZE		TOP	POWER	LAMINATE		
WIDTH	DEPTH	SECTIONS	QUANTITY	PRICE M1	PRICE H1	PRICE K1
180"	42"	2	2	\$3,890	\$4,566	\$5,806
192"	42"	2	2	\$3,992	\$4,668	\$5,909
204"	42"	3	1, 2, 3	\$4,052	\$4,729	\$5,972
216"	42"	3	1, 2, 3	\$4,105	\$4,782	\$6,028
228"	42"	3	1, 2, 3	\$4,968	\$5,981	\$7,830
240"	42"	3	1, 2, 3	\$5,021	\$6,034	\$7,885
252"	42"	3	1, 2, 3	\$5,088	\$6,100	\$7,958
264"	42"	3	1, 2, 3	\$5,141	\$6,154	\$8,012
276"	42"	3	1, 2, 3	\$5,194	\$6,209	\$8,066
288"	42"	3	1, 2, 3	\$5,247	\$6,262	\$8,120
180"	48"	2	2	\$3,947	\$4,621	\$5,862
192"	48"	2	2	\$4,048	\$4,724	\$5,966
204"	48"	3	1, 2, 3	\$4,109	\$4,783	\$6,030
216"	48"	3	1, 2, 3	\$4,162	\$4,838	\$6,083
228"	48"	3	1, 2, 3	\$5,022	\$6,037	\$7,887
240"	48"	3	1, 2, 3	\$5,075	\$6,090	\$7,941
252"	48"	3	1, 2, 3	\$5,142	\$6,157	\$8,015
264"	48"	3	1, 2, 3	\$5,196	\$6,210	\$8,069
276"	48"	3	1, 2, 3	\$5,250	\$6,263	\$8,122
288"	48"	3	1, 2, 3	\$5,303	\$6,316	\$8,176
180"	54"	2	2	\$4,002	\$4,678	\$5,920
192"	54"	2	2	\$4,104	\$4,780	\$6,023
204"	54"	3	1, 2, 3	\$4,165	\$4,840	\$6,089
216"	54"	3	1, 2, 3	\$4,218	\$4,893	\$6,143
228"	54"	3	1, 2, 3	\$5,079	\$6,093	\$7,947
240"	54"	3	1, 2, 3	\$5,131	\$6,147	\$8,000
252"	54"	3	1, 2, 3	\$5,199	\$6,213	\$8,076
264"	54"	3	1, 2, 3	\$5,252	\$6,266	\$8,129
276"	54"	3	1, 2, 3	\$5,305	\$6,320	\$8,182
288"	54"	3	1, 2, 3	\$5,358	\$6,374	\$8,236
180"	60"	2	2	\$4,055	\$4,731	\$5,973
192"	60"	2	2	\$4,157	\$4,833	\$6,078
204"	60"	3	1, 2, 3	\$4,218	\$4,893	\$6,143
216"	60"	3	1, 2, 3	\$4,272	\$4,947	\$6,197
228"	60"	3	1, 2, 3	\$5,131	\$6,147	\$8,000
240"	60"	3	1, 2, 3	\$5,186	\$6,200	\$8,052
252"	60"	3	1, 2, 3	\$5,252	\$6,266	\$8,129
264"	60"	3	1, 2, 3	\$5,305	\$6,320	\$8,182
276"	60"	3	1, 2, 3	\$5,358	\$6,374	\$8,236
288"	60"	3	1, 2, 3	\$5,412	\$6,426	\$8,289

**ORDER CODE SAMPLE**

LINE 1	TABLE	ITEM CODE	WIDTH	DEPTH	LAMINATE	OPTION
		TFBAT	W276	D48	M1	CC
LINE 1.1	POWER & DATA	POWER OPTION	FINISH / TRIM FINISH / COVER CODE	BODY FINISH / OPTION	POWER QTY	
		AF2RE	SLV	D	1	

**Features & Specifications**

No Charge Options

Optional Extra

- Laminate codes - M1: 1" LPL, H1: 1" HPL, K1: 1.25" knife edge (top only)
- Base legs available in chrome only; upper frames are black
- Height is 29" nominal, including levellers, including levellers
- Available in all standard laminates
- For 3" curved corners add option code "CC" and \$349

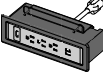
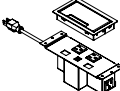
POWER & DATA					
For detailed specification, cover code finishes, data and telecom options, and pricing of each electrical modules please refer to page "Power & Data Options".					
 <p><b>AF2RE</b></p>	<p><b>Finish:</b> Black (BLK), Silver (SLV), White (WHT), Anodized Aluminum (BAA), Stainless Steel (BSS)</p>	 <p><b>AF3AE</b></p>	<p><b>Trim Finish:</b> Black (BLK), Silver (SLV), White (WHT)</p>	 <p><b>AU2FE</b></p>	<p><b>Cover Code:</b> F-AL, F-S, F-B, F-W</p>
	<p><b>Option (Data &amp; Telecom):</b> A, B, C, D, E, F, G, H, J, K</p>		<p><b>Body Finish:</b> White (WHT), Gray (GRY), Black (BLK), Orange (ORN), Red (RED), Green (GRN), Blue (BLU)</p>		<p><b>Option (Data &amp; Telecom):</b> C, K</p>

PRODUCT MAP  
CONFERENCE TABLES  
MEDIA TABLES  
PARSONS TABLES  
MEETING & CASUAL TABLES  
NEST TRAINING TABLES  
www.brc.group

# BRC Fit Table - 4 Leg

TFBCT

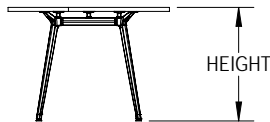
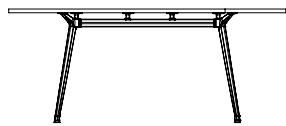
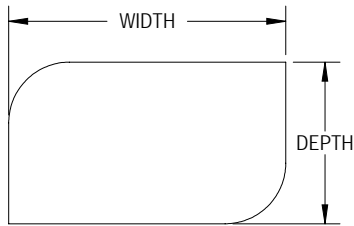
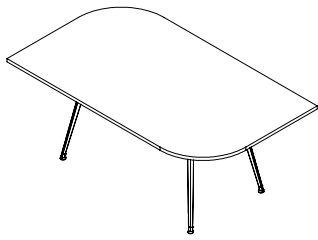

NOMINAL SIZE		TOP	POWER	LAMINATE		
WIDTH	DEPTH	SECTIONS	QUANTITY	PRICE M1	PRICE H1	PRICE K1
60"	30"	1	0	\$1,721	\$2,057	\$2,674
72"	30"	1	0	\$1,722	\$2,058	\$2,678
60"	36"	1	1	\$1,709	\$2,028	\$2,596
72"	36"	1	1	\$1,724	\$2,062	\$2,680
72"	42"	1	1	\$1,680	\$2,017	\$2,639
78"	42"	1	1	\$1,710	\$2,050	\$2,670
84"	42"	1	1	\$1,782	\$2,118	\$2,743
90"	42"	1	1	\$1,812	\$2,152	\$2,774
96"	42"	1	1	\$1,839	\$2,178	\$2,801
72"	48"	1	1	\$1,708	\$2,046	\$2,668
78"	48"	1	1	\$1,739	\$2,077	\$2,699
84"	48"	1	1	\$1,810	\$2,148	\$2,772
90"	48"	1	1	\$1,841	\$2,179	\$2,804
96"	48"	1	1	\$1,868	\$2,206	\$2,831
72"	54"	1	1	\$1,739	\$2,077	\$2,699
78"	54"	1	1	\$1,769	\$2,106	\$2,731
84"	54"	1	1	\$1,841	\$2,179	\$2,804
90"	54"	1	1	\$1,871	\$2,208	\$2,837
96"	54"	1	1	\$1,897	\$2,235	\$2,863
72"	60"	1	1	\$1,765	\$2,104	\$2,726
78"	60"	1	1	\$1,795	\$2,133	\$2,758
84"	60"	1	1	\$1,868	\$2,206	\$2,831
90"	60"	1	1	\$1,897	\$2,235	\$2,863
96"	60"	1	1	\$1,924	\$2,262	\$2,890

**ORDER CODE SAMPLE**

LINE 1	TABLE	ITEM CODE	WIDTH	DEPTH	LAMINATE
		TFBCT	W96	D48	M1
LINE 1.1	POWER & DATA	POWER OPTION	FINISH / TRIM FINISH / COVER CODE	BODY FINISH / OPTION	POWER QTY
		AF2RE	SLV	D	1

**Features & Specifications**

No Charge Options

- Laminate codes - M1: 1" LPL, H1: 1" HPL, K1: 1.25" knife edge (top only)
- Base legs available in chrome only; upper frames are black
- Height is 29" nominal, including levellers, including levellers
- Available in all standard laminates

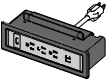
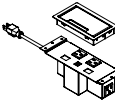
POWER & DATA					
For detailed specification, cover code finishes, data and telecom options, and pricing of each electrical modules please refer to page "Power & Data Options".					
<b>AF2RE</b> 	<b>Finish:</b> Black (BLK), Silver (SLV), White (WHT), Anodized Aluminum (BAA), Stainless Steel (BSS)	<b>AF3AE</b> 	<b>Trim Finish:</b> Black (BLK), Silver (SLV), White (WHT)	<b>AU2FE</b> 	<b>Cover Code:</b> F-AL, F-S, F-B, F-W
	<b>Option (Data &amp; Telecom):</b> A, B, C, D, E, F, G, H, J, K		<b>Body Finish:</b> White (WHT), Gray (GRY), Black (BLK), Orange (ORN), Red (RED), Green (GRN), Blue (BLU)		<b>Option (Data &amp; Telecom):</b> C, K

PRODUCT MAP  
CONFERENCE TABLES  
MEDIA TABLES  
PARSONS TABLES  
MEETING & CASUAL TABLES  
NEST TRAINING TABLES  
www.brc.group

# BRC Fit Table - 6 Leg

TFBCT

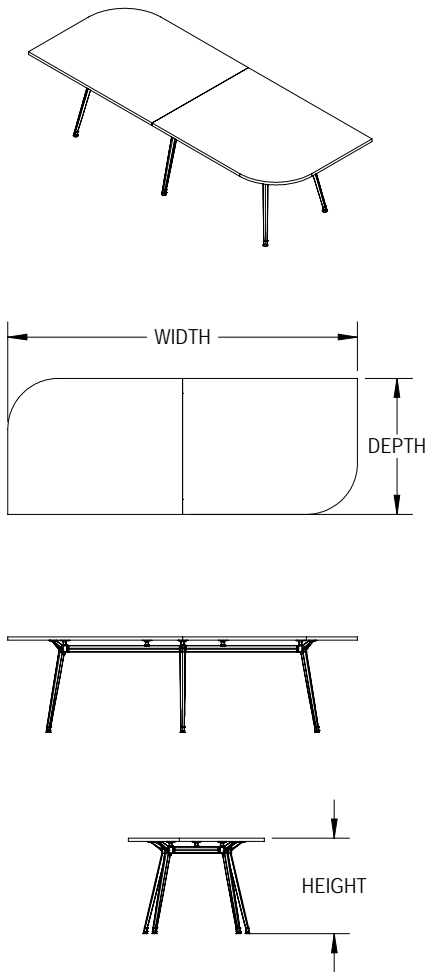

NOMINAL SIZE		TOP	POWER	LAMINATE		
WIDTH	DEPTH	SECTIONS	QUANTITY	PRICE M1	PRICE H1	PRICE K1
108"	42"	2	2	\$2,220	\$2,559	\$3,185
120"	42"	2	2	\$3,079	\$3,753	\$4,983
132"	42"	2	2	\$3,134	\$3,812	\$5,043
144"	42"	2	2	\$3,194	\$3,869	\$5,101
156"	42"	2	2	\$3,294	\$3,971	\$5,205
168"	42"	2	2	\$3,350	\$4,028	\$5,265
108"	48"	2	2	\$2,263	\$2,600	\$3,229
120"	48"	2	2	\$3,121	\$3,797	\$5,025
132"	48"	2	2	\$3,178	\$3,853	\$5,085
144"	48"	2	2	\$3,234	\$3,910	\$5,143
156"	48"	2	2	\$3,336	\$4,013	\$5,249
168"	48"	2	2	\$3,394	\$4,069	\$5,306
108"	54"	2	2	\$2,307	\$2,645	\$3,275
120"	54"	2	2	\$3,164	\$3,841	\$5,072
132"	54"	2	2	\$3,222	\$3,897	\$5,130
144"	54"	2	2	\$3,279	\$3,953	\$5,190
156"	54"	2	2	\$3,382	\$4,055	\$5,294
168"	54"	2	2	\$3,437	\$4,113	\$5,353
108"	60"	2	2	\$2,302	\$2,641	\$3,271
120"	60"	2	2	\$3,158	\$3,837	\$5,067
132"	60"	2	2	\$3,216	\$3,893	\$5,126
144"	60"	2	2	\$3,274	\$3,950	\$5,186
156"	60"	2	2	\$3,375	\$4,052	\$5,291
168"	60"	2	2	\$3,433	\$4,109	\$5,348

**ORDER CODE SAMPLE**

LINE 1	TABLE	ITEM CODE	WIDTH	DEPTH	LAMINATE
		TFBCT	W144	D48	M1
LINE 1.1	POWER & DATA	POWER OPTION	FINISH / TRIM FINISH / COVER CODE	BODY FINISH / OPTION	POWER QTY
		AF2RE	SLV	D	2

**Features & Specifications**

No Charge Options

- Laminate codes - M1: 1" LPL, H1: 1" HPL, K1: 1.25" knife edge (top only)
- Base legs available in chrome only; upper frames are black
- Height is 29" nominal, including levellers, including levellers
- Available in all standard laminates

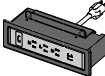
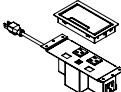
POWER & DATA	For detailed specification, cover code finishes, data and telecom options, and pricing of each electrical modules please refer to page "Power & Data Options".				
<b>AF2RE</b> 	<b>Finish:</b> Black (BLK), Silver (SLV), White (WHT), Anodized Aluminum (BAA), Stainless Steel (BSS)	<b>AF3AE</b> 	<b>Trim Finish:</b> Black (BLK), Silver (SLV), White (WHT)	<b>AU2FE</b> 	<b>Cover Code:</b> F-AL, F-S, F-B, F-W
	<b>Option (Data &amp; Telecom):</b> A, B, C, D, E, F, G, H, J, K		<b>Body Finish:</b> White (WHT), Gray (GRY), Black (BLK), Orange (ORN), Red (RED), Green (GRN), Blue (BLU)		<b>Option (Data &amp; Telecom):</b> C, K

PRODUCT MAP  
CONFERENCE TABLES  
MEDIA TABLES  
PARSONS TABLES  
MEETING & CASUAL TABLES  
NEST TRAINING TABLES  
www.brc.group

# BRC Fit Table - 8 Leg

TFBCT

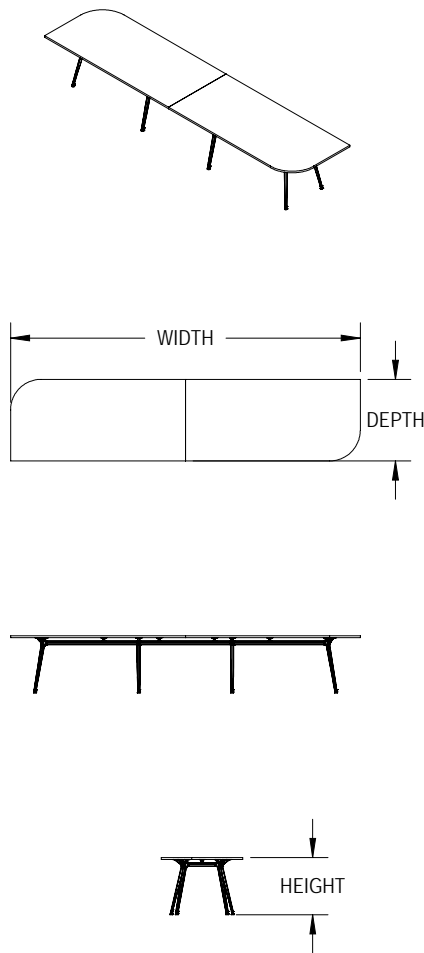

NOMINAL SIZE		TOP	POWER	LAMINATE		
WIDTH	DEPTH	SECTIONS	QUANTITY	PRICE M1	PRICE H1	PRICE K1
180"	42"	2	2	\$3,758	\$4,433	\$5,673
192"	42"	2	2	\$3,814	\$4,488	\$5,730
204"	42"	3	1, 2, 3	\$3,873	\$4,549	\$5,795
216"	42"	3	1, 2, 3	\$3,973	\$4,649	\$5,893
228"	42"	3	1, 2, 3	\$4,833	\$5,849	\$7,697
240"	42"	3	1, 2, 3	\$4,887	\$5,902	\$7,751
252"	42"	3	1, 2, 3	\$4,953	\$5,968	\$7,825
264"	42"	3	1, 2, 3	\$5,008	\$6,020	\$7,878
276"	42"	3	1, 2, 3	\$5,061	\$6,073	\$7,931
288"	42"	3	1, 2, 3	\$5,114	\$6,127	\$7,986
180"	48"	2	2	\$3,812	\$4,487	\$5,728
192"	48"	2	2	\$3,869	\$4,545	\$5,787
204"	48"	3	1, 2, 3	\$3,928	\$4,605	\$5,852
216"	48"	3	1, 2, 3	\$4,028	\$4,704	\$5,951
228"	48"	3	1, 2, 3	\$4,888	\$5,903	\$7,753
240"	48"	3	1, 2, 3	\$4,942	\$5,957	\$7,807
252"	48"	3	1, 2, 3	\$5,009	\$6,022	\$7,880
264"	48"	3	1, 2, 3	\$5,062	\$6,076	\$7,935
276"	48"	3	1, 2, 3	\$5,115	\$6,129	\$7,988
288"	48"	3	1, 2, 3	\$5,169	\$6,183	\$8,041
180"	54"	2	2	\$3,869	\$4,545	\$5,787
192"	54"	2	2	\$3,880	\$4,557	\$5,802
204"	54"	3	1, 2, 3	\$3,940	\$4,617	\$5,866
216"	54"	3	1, 2, 3	\$4,040	\$4,715	\$5,965
228"	54"	3	1, 2, 3	\$4,899	\$5,915	\$7,768
240"	54"	3	1, 2, 3	\$4,953	\$5,968	\$7,822
252"	54"	3	1, 2, 3	\$5,021	\$6,036	\$7,897
264"	54"	3	1, 2, 3	\$5,074	\$6,089	\$7,950
276"	54"	3	1, 2, 3	\$5,128	\$6,143	\$8,004
288"	54"	3	1, 2, 3	\$5,181	\$6,197	\$8,057
180"	60"	2	2	\$3,877	\$4,553	\$5,795
192"	60"	2	2	\$3,934	\$4,610	\$5,855
204"	60"	3	1, 2, 3	\$3,994	\$4,670	\$5,919
216"	60"	3	1, 2, 3	\$4,093	\$4,768	\$6,018
228"	60"	3	1, 2, 3	\$4,953	\$5,968	\$7,822
240"	60"	3	1, 2, 3	\$5,008	\$6,021	\$7,874
252"	60"	3	1, 2, 3	\$5,074	\$6,089	\$7,950
264"	60"	3	1, 2, 3	\$5,128	\$6,143	\$8,004
276"	60"	3	1, 2, 3	\$5,181	\$6,197	\$8,057
288"	60"	3	1, 2, 3	\$5,236	\$6,249	\$8,110

**ORDER CODE SAMPLE**

LINE 1	TABLE	ITEM CODE	WIDTH	DEPTH	LAMINATE
		TFBCT	W276	D48	M1
LINE 1.1	POWER & DATA	POWER OPTION	FINISH / TRIM FINISH / COVER CODE	BODY FINISH / OPTION	POWER QTY
		AF2RE	SLV	D	1

**Features & Specifications**

No Charge Options

Optional Extra

- Laminate codes - M1: 1" LPL, H1: 1" HPL, K1: 1.25" knife edge (top only)
- Base legs available in chrome only; upper frames are black
- Height is 29" nominal, including levellers, including levellers
- Available in all standard laminates
- For 3" curved corners add option code "CC" and \$349

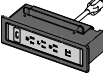
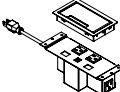
POWER & DATA					
For detailed specification, cover code finishes, data and telecom options, and pricing of each electrical modules please refer to page "Power & Data Options".					
 <p><b>AF2RE</b></p>	<p><b>Finish:</b> Black (BLK), Silver (SLV), White (WHT), Anodized Aluminum (BAA), Stainless Steel (BSS)</p>	 <p><b>AF3AE</b></p>	<p><b>Trim Finish:</b> Black (BLK), Silver (SLV), White (WHT)</p>	 <p><b>AU2FE</b></p>	<p><b>Cover Code:</b> F-AL, F-S, F-B, F-W</p>
	<p><b>Option (Data &amp; Telecom):</b> A, B, C, D, E, F, G, H, J, K</p>		<p><b>Body Finish:</b> White (WHT), Gray (GRY), Black (BLK), Orange (ORN), Red (RED), Green (GRN), Blue (BLU)</p>		<p><b>Option (Data &amp; Telecom):</b> C, K</p>

PRODUCT MAP  
CONFERENCE TABLES  
MEDIA TABLES  
PARSONS TABLES  
MEETING & CASUAL TABLES  
NEST TRAINING TABLES  
www.brc.group

# Trapezoid Fit Table - 4 Leg

TFTZT

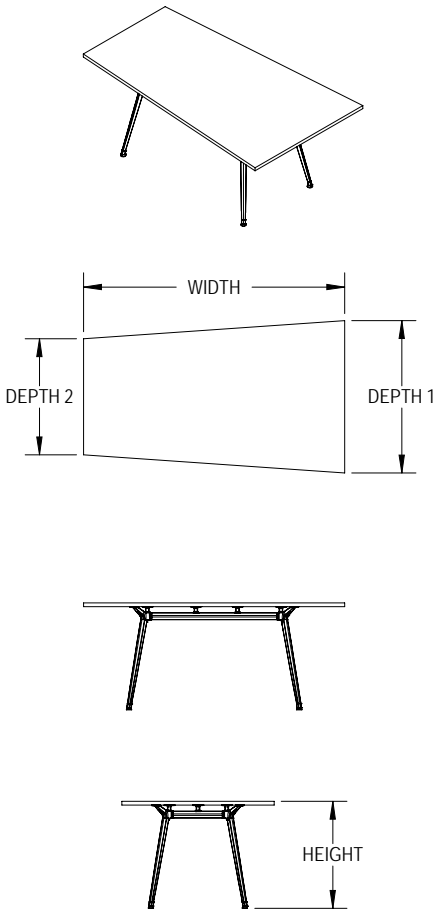

NOMINAL SIZE			TOP	POWER	LAMINATE		
WIDTH	DEPTH 1	DEPTH 2	SECTIONS	QUANTITY	PRICE M1	PRICE H1	PRICE K1
72"	42"	32"	1	1	\$1,680	\$2,017	\$2,639
78"	42"	32"	1	1	\$1,710	\$2,050	\$2,670
84"	42"	32"	1	1	\$1,782	\$2,118	\$2,743
90"	42"	32"	1	1	\$1,812	\$2,152	\$2,774
96"	42"	32"	1	1	\$1,839	\$2,178	\$2,801
72"	48"	38"	1	1	\$1,708	\$2,046	\$2,668
78"	48"	38"	1	1	\$1,739	\$2,077	\$2,699
84"	48"	38"	1	1	\$1,810	\$2,148	\$2,772
90"	48"	38"	1	1	\$1,841	\$2,179	\$2,804
96"	48"	38"	1	1	\$1,868	\$2,206	\$2,831
72"	54"	44"	1	1	\$1,739	\$2,077	\$2,699
78"	54"	44"	1	1	\$1,769	\$2,106	\$2,731
84"	54"	44"	1	1	\$1,841	\$2,179	\$2,804
90"	54"	44"	1	1	\$1,871	\$2,208	\$2,837
96"	54"	44"	1	1	\$1,897	\$2,235	\$2,863
72"	60"	50"	1	1	\$1,765	\$2,104	\$2,726
78"	60"	50"	1	1	\$1,795	\$2,133	\$2,758
84"	60"	50"	1	1	\$1,868	\$2,206	\$2,831
90"	60"	50"	1	1	\$1,897	\$2,235	\$2,863
96"	60"	50"	1	1	\$1,924	\$2,262	\$2,890

**ORDER CODE SAMPLE**

LINE 1	TABLE	ITEM CODE	WIDTH	DEPTH 1	DEPTH 2	LAMINATE	OPTION
		TFTZT	W96	D48	D38	M1	CC
LINE 1.1	POWER & DATA	POWER OPTION	FINISH / TRIM FINISH / COVER CODE	BODY FINISH / OPTION		POWER QTY	
		AF2RE	SLV	D		1	

**Features & Specifications**

No Charge Options

Optional Extra

- Laminate codes - M1: 1" LPL, H1: 1" HPL, K1: 1.25" knife edge (top only)
- Base legs available in chrome only; upper frames are black
- Height is 29" nominal, including levellers, including levellers
- Available in all standard laminates
- For 3" curved corners add option code "CC" and \$349

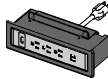
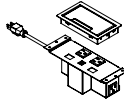
POWER & DATA	For detailed specification, cover code finishes, data and telecom options, and pricing of each electrical modules please refer to page "Power & Data Options".				
<b>AF2RE</b> 	<b>Finish:</b> Black (BLK), Silver (SLV), White (WHT), Anodized Aluminum (BAA), Stainless Steel (BSS)	<b>AF3AE</b> 	<b>Trim Finish:</b> Black (BLK), Silver (SLV), White (WHT)	<b>AU2FE</b> 	<b>Cover Code:</b> F-AL, F-S, F-B, F-W
	<b>Option (Data &amp; Telecom):</b> A, B, C, D, E, F, G, H, J, K		<b>Body Finish:</b> White (WHT), Gray (GRY), Black (BLK), Orange (ORN), Red (RED), Green (GRN), Blue (BLU)		<b>Option (Data &amp; Telecom):</b> C, K

# Trapezoid Fit Table - 6 Leg

TFTZT

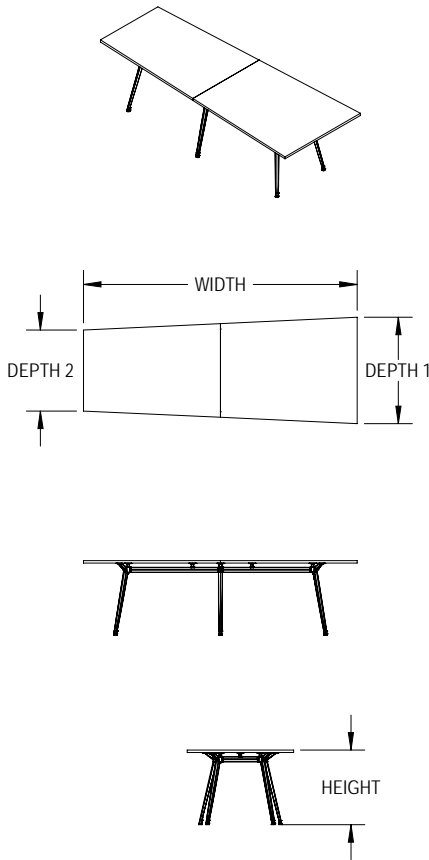

NOMINAL SIZE			TOP	POWER	LAMINATE		
WIDTH	DEPTH 1	DEPTH 2	SECTIONS	QUANTITY	PRICE M1	PRICE H1	PRICE K1
108"	42"	32"	2	2	\$2,220	\$2,559	\$3,185
120"	42"	32"	2	2	\$3,079	\$3,753	\$4,983
132"	42"	32"	2	2	\$3,134	\$3,812	\$5,043
144"	42"	32"	2	2	\$3,194	\$3,869	\$5,101
156"	42"	32"	2	2	\$3,294	\$3,971	\$5,205
168"	42"	32"	2	2	\$3,350	\$4,028	\$5,265
108"	48"	38"	2	2	\$2,263	\$2,600	\$3,229
120"	48"	38"	2	2	\$3,121	\$3,797	\$5,025
132"	48"	38"	2	2	\$3,178	\$3,853	\$5,085
144"	48"	38"	2	2	\$3,234	\$3,910	\$5,143
156"	48"	38"	2	2	\$3,336	\$4,013	\$5,249
168"	48"	38"	2	2	\$3,394	\$4,069	\$5,306
108"	54"	44"	2	2	\$2,307	\$2,645	\$3,275
120"	54"	44"	2	2	\$3,164	\$3,841	\$5,072
132"	54"	44"	2	2	\$3,222	\$3,897	\$5,130
144"	54"	44"	2	2	\$3,279	\$3,953	\$5,190
156"	54"	44"	2	2	\$3,382	\$4,055	\$5,294
168"	54"	44"	2	2	\$3,437	\$4,113	\$5,353
108"	60"	50"	2	2	\$2,302	\$2,641	\$3,271
120"	60"	50"	2	2	\$3,158	\$3,837	\$5,067
132"	60"	50"	2	2	\$3,216	\$3,893	\$5,126
144"	60"	50"	2	2	\$3,274	\$3,950	\$5,186
156"	60"	50"	2	2	\$3,375	\$4,052	\$5,291
168"	60"	50"	2	2	\$3,433	\$4,109	\$5,348

**ORDER CODE SAMPLE**

LINE 1	TABLE	ITEM CODE	WIDTH	DEPTH 1	DEPTH 2	LAMINATE	OPTION
		TFTZT	W144	D48	D38	M1	CC
LINE 1.1	POWER & DATA	POWER OPTION	FINISH / TRIM FINISH / COVER CODE	BODY FINISH / OPTION		POWER QTY	
		AF2RE	SLV	D		2	

**Features & Specifications**

No Charge Options

Optional Extra

- Laminate codes - M1: 1" LPL, H1: 1" HPL, K1: 1.25" knife edge (top only)
- Base legs available in chrome only; upper frames are black
- Height is 29" nominal, including levellers, including levellers
- Available in all standard laminates
- For 3" curved corners add option code "CC" and \$349

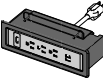
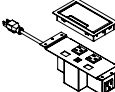
POWER & DATA	For detailed specification, cover code finishes, data and telecom options, and pricing of each electrical modules please refer to page "Power & Data Options".				
<b>AF2RE</b> 	<b>Finish:</b> Black (BLK), Silver (SLV), White (WHT), Anodized Aluminum (BAA), Stainless Steel (BSS)	<b>AF3AE</b> 	<b>Trim Finish:</b> Black (BLK), Silver (SLV), White (WHT)	<b>AU2FE</b> 	<b>Cover Code:</b> F-AL, F-S, F-B, F-W
	<b>Option (Data &amp; Telecom):</b> A, B, C, D, E, F, G, H, J, K		<b>Body Finish:</b> White (WHT), Gray (GRY), Black (BLK), Orange (ORN), Red (RED), Green (GRN), Blue (BLU)		<b>Option (Data &amp; Telecom):</b> C, K

PRODUCT MAP  
CONFERENCE TABLES  
MEDIA TABLES  
PARSONS TABLES  
MEETING & CASUAL TABLES  
NEST TRAINING TABLES  
www.brc.group

# Trapezoid Fit Table - 8 Leg

TFTZT

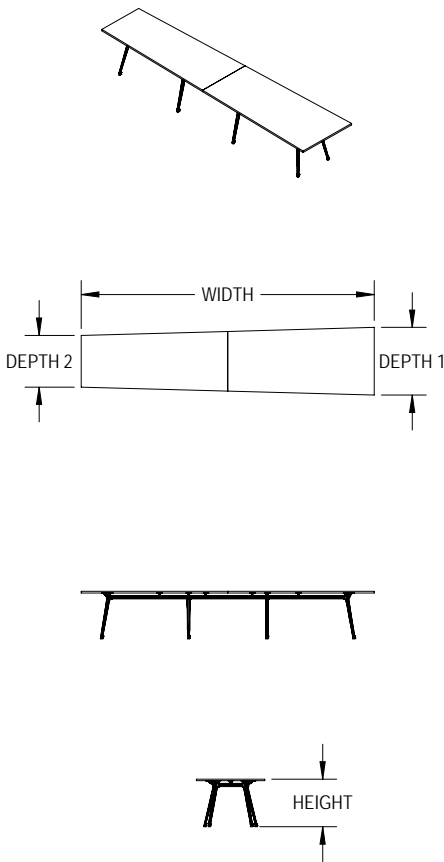

NOMINAL SIZE			TOP	POWER	LAMINATE		
WIDTH	DEPTH 1	DEPTH 2	SECTIONS	QUANTITY	PRICE M1	PRICE H1	PRICE K1
180"	42"	32"	2	2	\$3,758	\$4,433	\$5,673
192"	42"	32"	2	2	\$3,814	\$4,488	\$5,730
204"	42"	32"	3	1, 2, 3	\$3,873	\$4,549	\$5,795
216"	42"	32"	3	1, 2, 3	\$3,973	\$4,649	\$5,893
228"	42"	32"	3	1, 2, 3	\$4,833	\$5,849	\$7,697
240"	42"	32"	3	1, 2, 3	\$4,887	\$5,902	\$7,751
252"	42"	32"	3	1, 2, 3	\$4,953	\$5,968	\$7,825
264"	42"	32"	3	1, 2, 3	\$5,008	\$6,020	\$7,878
276"	42"	32"	3	1, 2, 3	\$5,061	\$6,073	\$7,931
288"	42"	32"	3	1, 2, 3	\$5,114	\$6,127	\$7,986
180"	48"	38"	2	2	\$3,812	\$4,487	\$5,728
192"	48"	38"	2	2	\$3,869	\$4,545	\$5,787
204"	48"	38"	3	1, 2, 3	\$3,928	\$4,605	\$5,852
216"	48"	38"	3	1, 2, 3	\$4,028	\$4,704	\$5,951
228"	48"	38"	3	1, 2, 3	\$4,888	\$5,903	\$7,753
240"	48"	38"	3	1, 2, 3	\$4,942	\$5,957	\$7,807
252"	48"	38"	3	1, 2, 3	\$5,009	\$6,022	\$7,880
264"	48"	38"	3	1, 2, 3	\$5,062	\$6,076	\$7,935
276"	48"	38"	3	1, 2, 3	\$5,115	\$6,129	\$7,988
288"	48"	38"	3	1, 2, 3	\$5,169	\$6,183	\$8,041
180"	54"	44"	2	2	\$3,869	\$4,545	\$5,787
192"	54"	44"	2	2	\$3,880	\$4,557	\$5,802
204"	54"	44"	3	1, 2, 3	\$3,940	\$4,617	\$5,866
216"	54"	44"	3	1, 2, 3	\$4,040	\$4,715	\$5,965
228"	54"	44"	3	1, 2, 3	\$4,899	\$5,915	\$7,768
240"	54"	44"	3	1, 2, 3	\$4,953	\$5,968	\$7,822
252"	54"	44"	3	1, 2, 3	\$5,021	\$6,036	\$7,897
264"	54"	44"	3	1, 2, 3	\$5,074	\$6,089	\$7,950
276"	54"	44"	3	1, 2, 3	\$5,128	\$6,143	\$8,004
288"	54"	44"	3	1, 2, 3	\$5,181	\$6,197	\$8,057
180"	60"	50"	2	2	\$3,877	\$4,553	\$5,795
192"	60"	50"	2	2	\$3,934	\$4,610	\$5,855
204"	60"	50"	3	1, 2, 3	\$3,994	\$4,670	\$5,919
216"	60"	50"	3	1, 2, 3	\$4,093	\$4,768	\$6,018
228"	60"	50"	3	1, 2, 3	\$4,953	\$5,968	\$7,822
240"	60"	50"	3	1, 2, 3	\$5,008	\$6,021	\$7,874
252"	60"	50"	3	1, 2, 3	\$5,074	\$6,089	\$7,950
264"	60"	50"	3	1, 2, 3	\$5,128	\$6,143	\$8,004
276"	60"	50"	3	1, 2, 3	\$5,181	\$6,197	\$8,057
288"	60"	50"	3	1, 2, 3	\$5,236	\$6,249	\$8,110

**ORDER CODE SAMPLE**

LINE 1	TABLE	ITEM CODE	WIDTH	DEPTH 1	DEPTH 2	LAMINATE	OPTION
		TFTZT	W276	D48	D38	M1	CC
LINE 1.1	POWER & DATA	POWER OPTION	FINISH / TRIM FINISH / COVER CODE	BODY FINISH / OPTION		POWER QTY	
		AF2RE	SLV	D		1	

**Features & Specifications**

No Charge Options

Optional Extra

- Laminate codes - M1: 1" LPL, H1: 1" HPL, K1: 1.25" knife edge (top only)
- Base legs available in chrome only; upper frames are black
- Height is 29" nominal, including levlers, including levlers
- Available in all standard laminates
- For 3" curved corners add option code "CC" and \$349

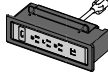
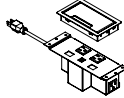
<b>POWER &amp; DATA</b>	For detailed specification, cover code finishes, data and telecom options, and pricing of each electrical modules please refer to page "Power & Data Options".				
 <b>AF2RE</b>	<b>Finish:</b> Black (BLK), Silver (SLV), White (WHT), Anodized Aluminum (BAA), Stainless Steel (BSS)	 <b>AF3AE</b>	<b>Trim Finish:</b> Black (BLK), Silver (SLV), White (WHT)	 <b>AU2FE</b>	<b>Cover Code:</b> F-AL, F-S, F-B, F-W
	<b>Option (Data &amp; Telecom):</b> A, B, C, D, E, F, G, H, J, K		<b>Body Finish:</b> White (WHT), Gray (GRY), Black (BLK), Orange (ORN), Red (RED), Green (GRN), Blue (BLU)		<b>Option (Data &amp; Telecom):</b> C, K

PRODUCT MAP  
CONFERENCE TABLES  
MEDIA TABLES  
PARSONS TABLES  
MEETING & CASUAL TABLES  
NEST TRAINING TABLES  
www.brc.group

# Rectangular Nova Table - 2 Base

TNRRT

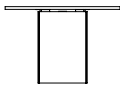
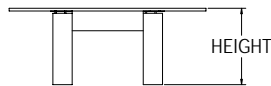
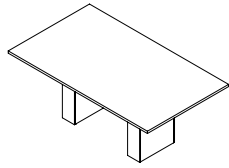

NOMINAL SIZE		TOP	POWER	LAMINATE		
WIDTH	DEPTH	SECTIONS	QUANTITY	PRICE M1	PRICE H1	PRICE K1
60"	30"	1	0	\$2,462	\$2,671	\$3,141
72"	30"	1	0	\$2,474	\$2,687	\$3,143
60"	36"	1	1	\$2,589	\$2,805	\$3,194
72"	36"	1	1	\$2,599	\$2,821	\$3,252
72"	42"	1	1	\$2,599	\$2,821	\$3,253
78"	42"	1	1	\$2,605	\$2,827	\$3,256
84"	42"	1	1	\$2,605	\$2,827	\$3,256
90"	42"	1	1	\$2,610	\$2,834	\$3,259
96"	42"	1	1	\$2,610	\$2,834	\$3,259
108"	42"	2	2	\$2,619	\$2,849	\$3,263
72"	48"	1	1	\$2,599	\$2,821	\$3,255
78"	48"	1	1	\$2,605	\$2,827	\$3,258
84"	48"	1	1	\$2,605	\$2,827	\$3,258
90"	48"	1	1	\$2,610	\$2,834	\$3,261
96"	48"	1	1	\$2,610	\$2,834	\$3,261
108"	48"	2	2	\$2,619	\$2,849	\$3,265
72"	54"	1	1	\$2,706	\$2,928	\$3,364
78"	54"	1	1	\$2,711	\$2,934	\$3,368
84"	54"	1	1	\$2,711	\$2,934	\$3,368
90"	54"	1	1	\$2,717	\$2,941	\$3,373
96"	54"	1	1	\$2,717	\$2,941	\$3,373
108"	54"	2	2	\$2,726	\$2,955	\$3,376
72"	60"	1	1	\$2,706	\$2,928	\$3,364
78"	60"	1	1	\$2,711	\$2,934	\$3,368
84"	60"	1	1	\$2,711	\$2,934	\$3,368
90"	60"	1	1	\$2,717	\$2,941	\$3,373
96"	60"	1	1	\$2,717	\$2,941	\$3,373
108"	60"	2	2	\$2,726	\$2,955	\$3,376

**ORDER CODE SAMPLE**

LINE 1	TABLE	ITEM CODE	WIDTH	DEPTH	LAMINATE	OPTION
		TNRRT	W96	D48	M1	CC
LINE 1.1	POWER & DATA	POWER OPTION	FINISH / TRIM FINISH / COVER CODE	BODY FINISH / OPTION	POWER QTY	
		AF2RE	SLV	D	1	

**Features & Specifications**

No Charge Options  
Optional Extra

- Laminate codes - M1: 1" LPL, H1: 1" HPL, K1: 1.25" knife edge (top only)
- Base laminate is 3/4" LPL
- Wire management in each leg
- Height is 29" nominal, including levellers, including levellers
- 108" Wide top is in two sections with seam
- Available in all standard laminates
- For 3" curved corners add option code "CC" and \$349

**POWER & DATA** For detailed specification, cover code finishes, data and telecom options, and pricing of each electrical modules please refer to page "Power & Data Options".

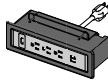
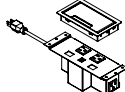
 <p><b>AF2RE</b></p>	<p><b>Finish:</b> Black (BLK), Silver (SLV), White (WHT), Anodized Aluminum (BAA), Stainless Steel (BSS)</p>	 <p><b>AF3AE</b></p>	<p><b>Trim Finish:</b> Black (BLK), Silver (SLV), White (WHT)</p>	 <p><b>AU2FE</b></p>	<p><b>Cover Code:</b> F-AL, F-S, F-B, F-W</p>
	<p><b>Option (Data &amp; Telecom):</b> A, B, C, D, E, F, G, H, J, K</p>		<p><b>Body Finish:</b> White (WHT), Gray (GRY), Black (BLK), Orange (ORN), Red (RED), Green (GRN), Blue (BLU)</p>		<p><b>Option (Data &amp; Telecom):</b> C, K</p>

# Rectangular Nova Table - 3 Base

TNRRT

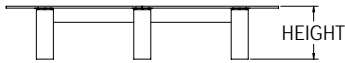
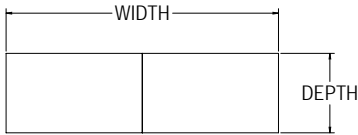
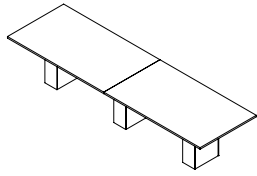

NOMINAL SIZE		TOP	POWER	LAMINATE		
WIDTH	DEPTH	SECTIONS	QUANTITY	PRICE M1	PRICE H1	PRICE K1
120"	42"	2	2	\$3,120	\$3,543	\$4,453
132"	42"	2	2	\$3,128	\$3,557	\$4,457
144"	42"	2	2	\$4,151	\$4,583	\$5,473
156"	42"	2	2	\$4,162	\$4,598	\$5,476
168"	42"	2	2	\$4,171	\$4,610	\$5,481
180"	42"	2	2	\$4,181	\$4,626	\$5,483
192"	42"	2	2	\$4,192	\$4,638	\$5,486
120"	48"	2	2	\$3,120	\$3,543	\$4,455
132"	48"	2	2	\$3,128	\$3,557	\$4,458
144"	48"	2	2	\$4,151	\$4,583	\$5,474
156"	48"	2	2	\$4,162	\$4,598	\$5,478
168"	48"	2	2	\$4,171	\$4,610	\$5,482
180"	48"	2	2	\$4,181	\$4,626	\$5,485
192"	48"	2	2	\$4,192	\$4,638	\$5,488
120"	48"	2	2	\$3,120	\$3,543	\$4,455
132"	48"	2	2	\$3,128	\$3,557	\$4,458
144"	54"	2	2	\$4,310	\$4,742	\$5,637
156"	54"	2	2	\$4,322	\$4,757	\$5,640
168"	54"	2	2	\$4,331	\$4,769	\$5,646
180"	54"	2	2	\$4,341	\$4,785	\$5,649
192"	54"	2	2	\$4,352	\$4,797	\$5,653
120"	60"	2	2	\$3,226	\$3,650	\$4,565
132"	60"	2	2	\$3,235	\$3,664	\$4,569
144"	60"	2	2	\$4,310	\$4,742	\$5,637
156"	60"	2	2	\$4,322	\$4,757	\$5,640
168"	60"	2	2	\$4,331	\$4,769	\$5,646
180"	60"	2	2	\$4,341	\$4,785	\$5,649
192"	60"	2	2	\$4,352	\$4,797	\$5,653

**ORDER CODE SAMPLE**

LINE 1	TABLE	ITEM CODE	WIDTH	DEPTH	LAMINATE	OPTION
		TNRRT	W144	D48	M1	CC
LINE 1.1	POWER & DATA	POWER OPTION	FINISH / TRIM FINISH / COVER CODE	BODY FINISH / OPTION	POWER QTY	
		AF2RE	SLV	D	2	

**Features & Specifications**

No Charge Options  
Optional Extra

- Laminate codes - M1: 1" LPL, H1: 1" HPL, K1: 1.25" knife edge (top only)
- Base laminate is 3/4" LPL
- Wire management in each leg
- Height is 29" nominal, including levellers, including levellers
- Available in all standard laminates
- For 3" curved corners add option code "CC" and \$349

**POWER & DATA** For detailed specification, cover code finishes, data and telecom options, and pricing of each electrical modules please refer to page "Power & Data Options".

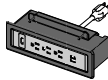
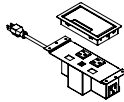
 <p><b>AF2RE</b></p>	<p><b>Finish:</b> Black (BLK), Silver (SLV), White (WHT), Anodized Aluminum (BAA), Stainless Steel (BSS)</p>	 <p><b>AF3AE</b></p>	<p><b>Trim Finish:</b> Black (BLK), Silver (SLV), White (WHT)</p>	 <p><b>AU2FE</b></p>	<p><b>Cover Code:</b> F-AL, F-S, F-B, F-W</p>
	<p><b>Option (Data &amp; Telecom):</b> A, B, C, D, E, F, G, H, J, K</p>		<p><b>Body Finish:</b> White (WHT), Gray (GRY), Black (BLK), Orange (ORN), Red (RED), Green (GRN), Blue (BLU)</p>		<p><b>Option (Data &amp; Telecom):</b> C, K</p>

# Rectangular Nova Table - 4 Base

TNRRT

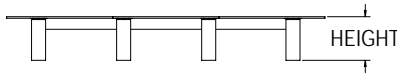
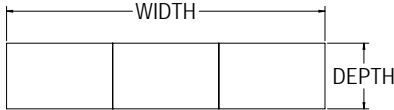
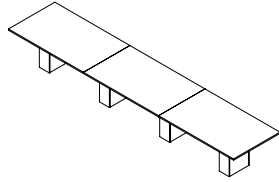

NOMINAL SIZE		TOP	POWER	LAMINATE		
WIDTH	DEPTH	SECTIONS	QUANTITY	PRICE M1	PRICE H1	PRICE K1
204"	42"	3	1, 2, 3	\$5,223	\$5,678	\$6,506
216"	42"	3	1, 2, 3	\$5,223	\$5,678	\$6,506
228"	42"	3	1, 2, 3	\$5,734	\$6,389	\$7,699
240"	42"	3	1, 2, 3	\$5,734	\$6,389	\$7,699
252"	42"	3	1, 2, 3	\$5,775	\$6,443	\$7,714
264"	42"	3	1, 2, 3	\$5,775	\$6,443	\$7,714
276"	42"	3	1, 2, 3	\$5,775	\$6,443	\$7,714
288"	42"	3	1, 2, 3	\$5,775	\$6,443	\$7,714
204"	48"	3	1, 2, 3	\$5,223	\$5,678	\$6,507
216"	48"	3	1, 2, 3	\$5,223	\$5,678	\$6,507
228"	48"	3	1, 2, 3	\$5,734	\$6,389	\$7,701
240"	48"	3	1, 2, 3	\$5,734	\$6,389	\$7,701
252"	48"	3	1, 2, 3	\$5,775	\$6,443	\$7,717
264"	48"	3	1, 2, 3	\$5,775	\$6,443	\$7,717
276"	48"	3	1, 2, 3	\$5,775	\$6,443	\$7,717
288"	48"	3	1, 2, 3	\$5,775	\$6,443	\$7,717
204"	54"	3	1, 2, 3	\$5,435	\$5,891	\$6,725
216"	54"	3	1, 2, 3	\$5,435	\$5,891	\$6,725
228"	54"	3	1, 2, 3	\$5,946	\$6,601	\$7,918
240"	54"	3	1, 2, 3	\$5,946	\$6,601	\$7,918
252"	54"	3	1, 2, 3	\$5,987	\$6,656	\$7,933
264"	54"	3	1, 2, 3	\$5,987	\$6,656	\$7,933
276"	54"	3	1, 2, 3	\$5,987	\$6,656	\$7,933
288"	54"	3	1, 2, 3	\$5,987	\$6,656	\$7,933
204"	60"	3	1, 2, 3	\$5,435	\$5,891	\$6,725
216"	60"	3	1, 2, 3	\$5,435	\$5,891	\$6,725
228"	60"	3	1, 2, 3	\$5,946	\$6,601	\$7,918
240"	60"	3	1, 2, 3	\$5,946	\$6,601	\$7,918
252"	60"	3	1, 2, 3	\$5,987	\$6,656	\$7,933
264"	60"	3	1, 2, 3	\$5,987	\$6,656	\$7,933
276"	60"	3	1, 2, 3	\$5,987	\$6,656	\$7,933
288"	60"	3	1, 2, 3	\$5,987	\$6,656	\$7,933

**ORDER CODE SAMPLE**

LINE 1	TABLE	ITEM CODE	WIDTH	DEPTH	LAMINATE	OPTION
		TNRRT	W276	D48	M1	CC
LINE 1.1	POWER & DATA	POWER OPTION	FINISH / TRIM FINISH / COVER CODE	BODY FINISH / OPTION	POWER QTY	
		AF2RE	SLV	D	1	

**Features & Specifications**

No Charge Options  
Optional Extra

- Laminate codes - M1: 1" LPL, H1: 1" HPL, K1: 1.25" knife edge (top only)
- Base laminate is 3/4" LPL
- Wire management in each leg
- Height is 29" nominal, including levellers, including levellers
- Available in all standard laminates
- For 3" curved corners add option code "CC" and \$349

**POWER & DATA** For detailed specification, cover code finishes, data and telecom options, and pricing of each electrical modules please refer to page "Power & Data Options".

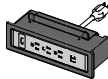
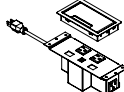
 <p><b>AF2RE</b></p>	<p><b>Finish:</b> Black (BLK), Silver (SLV), White (WHT), Anodized Aluminum (BAA), Stainless Steel (BSS)</p>	 <p><b>AF3AE</b></p>	<p><b>Trim Finish:</b> Black (BLK), Silver (SLV), White (WHT)</p>	 <p><b>AU2FE</b></p>	<p><b>Cover Code:</b> F-AL, F-S, F-B, F-W</p>
	<p><b>Option (Data &amp; Telecom):</b> A, B, C, D, E, F, G, H, J, K</p>		<p><b>Body Finish:</b> White (WHT), Gray (GRY), Black (BLK), Orange (ORN), Red (RED), Green (GRN), Blue (BLU)</p>		<p><b>Option (Data &amp; Telecom):</b> C, K</p>

# Boat Shape Nova Table - 2 Base

TNRAT

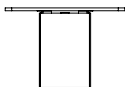
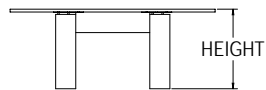
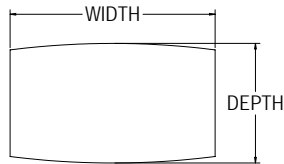
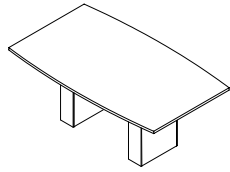

NOMINAL SIZE		TOP	POWER	LAMINATE		
WIDTH	DEPTH	SECTIONS	QUANTITY	PRICE M1	PRICE H1	PRICE K1
60"	30"	1	0	\$2,545	\$2,799	\$3,261
72"	30"	1	0	\$2,546	\$2,800	\$3,263
60"	36"	1	1	\$2,645	\$2,883	\$3,309
72"	36"	1	1	\$2,653	\$2,908	\$3,373
72"	42"	1	1	\$2,655	\$2,909	\$3,374
78"	42"	1	1	\$2,659	\$2,911	\$3,379
84"	42"	1	1	\$2,659	\$2,911	\$3,379
90"	42"	1	1	\$2,661	\$2,914	\$3,384
96"	42"	1	1	\$2,661	\$2,914	\$3,384
108"	42"	2	2	\$2,665	\$2,916	\$3,387
72"	48"	1	1	\$2,658	\$2,910	\$3,376
78"	48"	1	1	\$2,660	\$2,913	\$3,382
84"	48"	1	1	\$2,660	\$2,913	\$3,382
90"	48"	1	1	\$2,663	\$2,915	\$3,385
96"	48"	1	1	\$2,663	\$2,915	\$3,385
108"	48"	2	2	\$2,666	\$2,918	\$3,388
72"	54"	1	1	\$2,768	\$3,020	\$3,488
78"	54"	1	1	\$2,769	\$3,023	\$3,491
84"	54"	1	1	\$2,769	\$3,023	\$3,491
90"	54"	1	1	\$2,771	\$3,024	\$3,496
96"	54"	1	1	\$2,771	\$3,024	\$3,496
108"	54"	2	2	\$2,773	\$3,026	\$3,500
72"	60"	1	1	\$2,768	\$3,020	\$3,488
78"	60"	1	1	\$2,769	\$3,023	\$3,491
84"	60"	1	1	\$2,769	\$3,023	\$3,491
90"	60"	1	1	\$2,771	\$3,024	\$3,496
96"	60"	1	1	\$2,771	\$3,024	\$3,496
108"	60"	2	2	\$2,773	\$3,026	\$3,500

**ORDER CODE SAMPLE**

LINE 1	TABLE	ITEM CODE	WIDTH	DEPTH	LAMINATE	OPTION
		TNRAT	W96	D48	M1	CC
LINE 1.1	POWER & DATA	POWER OPTION	FINISH / TRIM FINISH / COVER CODE	BODY FINISH / OPTION	POWER QTY	
		AF2RE	SLV	D	1	

**Features & Specifications**

No Charge Options  
Optional Extra

- Laminate codes - M1: 1" LPL, H1: 1" HPL, K1: 1.25" knife edge (top only)
- Base laminate is 3/4" LPL
- Wire management in each leg
- Height is 29" nominal, including levellers, including levellers
- 108" Wide top is in two sections with seam
- Available in all standard laminates
- For 3" curved corners add option code "CC" and \$349

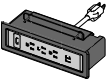
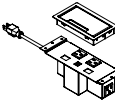
POWER & DATA	For detailed specification, cover code finishes, data and telecom options, and pricing of each electrical modules please refer to page "Power & Data Options".				
<b>AF2RE</b> 	<b>Finish:</b> Black (BLK), Silver (SLV), White (WHT), Anodized Aluminum (BAA), Stainless Steel (BSS)	<b>AF3AE</b> 	<b>Trim Finish:</b> Black (BLK), Silver (SLV), White (WHT)	<b>AU2FE</b> 	<b>Cover Code:</b> F-AL, F-S, F-B, F-W
	<b>Option (Data &amp; Telecom):</b> A, B, C, D, E, F, G, H, J, K		<b>Body Finish:</b> White (WHT), Gray (GRY), Black (BLK), Orange (ORN), Red (RED), Green (GRN), Blue (BLU)		<b>Option (Data &amp; Telecom):</b> C, K

PRODUCT MAP  
CONFERENCE TABLES  
MEDIA TABLES  
PARSONS TABLES  
MEETING & CASUAL TABLES  
NEST TRAINING TABLES  
www.brc.group

# Boat Shape Nova Table - 3 Base

TNRAT

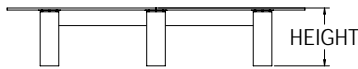
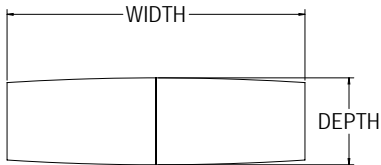
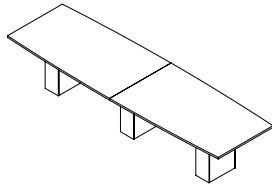

NOMINAL SIZE		TOP	POWER	LAMINATE		
WIDTH	DEPTH	SECTIONS	QUANTITY	PRICE M1	PRICE H1	PRICE K1
120"	42"	2	2	\$3,266	\$3,772	\$4,695
132"	42"	2	2	\$3,268	\$3,775	\$4,700
144"	42"	2	2	\$4,283	\$4,790	\$5,715
156"	42"	2	2	\$4,285	\$4,792	\$5,718
168"	42"	2	2	\$4,288	\$4,795	\$5,724
180"	42"	2	2	\$4,293	\$4,797	\$5,727
192"	42"	2	2	\$4,294	\$4,802	\$5,731
120"	48"	2	2	\$3,267	\$3,773	\$4,696
132"	48"	2	2	\$3,271	\$3,777	\$4,701
144"	48"	2	2	\$4,284	\$4,791	\$5,717
156"	48"	2	2	\$4,286	\$4,793	\$5,723
168"	48"	2	2	\$4,290	\$4,796	\$5,726
180"	48"	2	2	\$4,294	\$4,798	\$5,729
192"	48"	2	2	\$4,295	\$4,803	\$5,734
120"	54"	2	2	\$3,376	\$3,884	\$4,808
132"	54"	2	2	\$3,379	\$3,886	\$4,812
144"	54"	2	2	\$4,447	\$4,953	\$5,881
156"	54"	2	2	\$4,449	\$4,957	\$5,885
168"	54"	2	2	\$4,453	\$4,959	\$5,889
180"	54"	2	2	\$4,456	\$4,962	\$5,892
192"	54"	2	2	\$4,458	\$4,964	\$5,896
120"	60"	2	2	\$3,376	\$3,884	\$4,808
132"	60"	2	2	\$3,379	\$3,886	\$4,812
144"	60"	2	2	\$4,447	\$4,953	\$5,881
156"	60"	2	2	\$4,449	\$4,957	\$5,885
168"	60"	2	2	\$4,453	\$4,959	\$5,889
180"	60"	2	2	\$4,456	\$4,962	\$5,892
192"	60"	2	2	\$4,458	\$4,964	\$5,896

**ORDER CODE SAMPLE**

LINE 1	TABLE	ITEM CODE	WIDTH	DEPTH	LAMINATE	OPTION
		TNRAT	W144	D48	M1	CC
LINE 1.1	POWER & DATA	POWER OPTION	FINISH / TRIM FINISH / COVER CODE	BODY FINISH / OPTION	POWER QTY	
		AF2RE	SLV	D	2	

**Features & Specifications**

No Charge Options  
Optional Extra

- Laminate codes - M1: 1" LPL, H1: 1" HPL, K1: 1.25" knife edge (top only)
- Base laminate is 3/4" LPL
- Wire management in each leg
- Height is 29" nominal, including levellers, including levellers
- Available in all standard laminates
- For 3" curved corners add option code "CC" and \$349

**POWER & DATA** For detailed specification, cover code finishes, data and telecom options, and pricing of each electrical modules please refer to page "Power & Data Options".

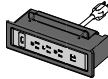
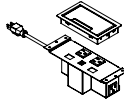
 <p><b>AF2RE</b></p>	<p><b>Finish:</b> Black (BLK), Silver (SLV), White (WHT), Anodized Aluminum (BAA), Stainless Steel (BSS)</p>	 <p><b>AF3AE</b></p>	<p><b>Trim Finish:</b> Black (BLK), Silver (SLV), White (WHT)</p>	 <p><b>AU2FE</b></p>	<p><b>Cover Code:</b> F-AL, F-S, F-B, F-W</p>
	<p><b>Option (Data &amp; Telecom):</b> A, B, C, D, E, F, G, H, J, K</p>		<p><b>Body Finish:</b> White (WHT), Gray (GRY), Black (BLK), Orange (ORN), Red (RED), Green (GRN), Blue (BLU)</p>		<p><b>Option (Data &amp; Telecom):</b> C, K</p>

# Boat Shape Nova Table - 4 Base

TNRAT

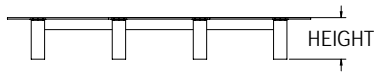
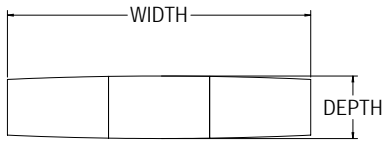
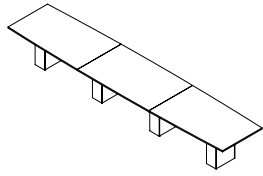

NOMINAL SIZE		TOP	POWER	LAMINATE		
WIDTH	DEPTH	SECTIONS	QUANTITY	PRICE M1	PRICE H1	PRICE K1
204"	42"	3	1, 2, 3	\$5,310	\$5,817	\$6,752
216"	42"	3	1, 2, 3	\$5,310	\$5,817	\$6,752
228"	42"	3	1, 2, 3	\$5,916	\$6,677	\$8,064
240"	42"	3	1, 2, 3	\$5,916	\$6,677	\$8,064
252"	42"	3	1, 2, 3	\$5,928	\$6,686	\$8,080
264"	42"	3	1, 2, 3	\$5,928	\$6,686	\$8,080
276"	42"	3	1, 2, 3	\$5,928	\$6,686	\$8,080
288"	42"	3	1, 2, 3	\$5,928	\$6,686	\$8,080
204"	48"	3	1, 2, 3	\$5,313	\$5,819	\$6,754
216"	48"	3	1, 2, 3	\$5,313	\$5,819	\$6,754
228"	48"	3	1, 2, 3	\$5,917	\$6,678	\$8,066
240"	48"	3	1, 2, 3	\$5,917	\$6,678	\$8,066
252"	48"	3	1, 2, 3	\$5,929	\$6,687	\$8,082
264"	48"	3	1, 2, 3	\$5,929	\$6,687	\$8,082
276"	48"	3	1, 2, 3	\$5,929	\$6,687	\$8,082
288"	48"	3	1, 2, 3	\$5,929	\$6,687	\$8,082
204"	54"	3	1, 2, 3	\$5,527	\$6,036	\$6,972
216"	54"	3	1, 2, 3	\$5,527	\$6,036	\$6,972
228"	54"	3	1, 2, 3	\$6,133	\$6,895	\$8,283
240"	54"	3	1, 2, 3	\$6,133	\$6,895	\$8,283
252"	54"	3	1, 2, 3	\$6,144	\$6,904	\$8,300
264"	54"	3	1, 2, 3	\$6,144	\$6,904	\$8,300
276"	54"	3	1, 2, 3	\$6,144	\$6,904	\$8,300
288"	54"	3	1, 2, 3	\$6,144	\$6,904	\$8,300
204"	60"	3	1, 2, 3	\$5,527	\$6,036	\$6,972
216"	60"	3	1, 2, 3	\$5,527	\$6,036	\$6,972
228"	60"	3	1, 2, 3	\$6,133	\$6,895	\$8,283
240"	60"	3	1, 2, 3	\$6,133	\$6,895	\$8,283
252"	60"	3	1, 2, 3	\$6,144	\$6,904	\$8,300
264"	60"	3	1, 2, 3	\$6,144	\$6,904	\$8,300
276"	60"	3	1, 2, 3	\$6,144	\$6,904	\$8,300
288"	60"	3	1, 2, 3	\$6,144	\$6,904	\$8,300

**ORDER CODE SAMPLE**

LINE 1	TABLE	ITEM CODE	WIDTH	DEPTH	LAMINATE	OPTION
		TNRAT	W276	D48	M1	CC
LINE 1.1	POWER & DATA	POWER OPTION	FINISH / TRIM FINISH / COVER CODE	BODY FINISH / OPTION	POWER QTY	
		AF2RE	SLV	D	1	

**Features & Specifications**

No Charge Options  
Optional Extra

- Laminate codes - M1: 1" LPL, H1: 1" HPL, K1: 1.25" knife edge (top only)
- Base laminate is 3/4" LPL
- Wire management in each leg
- Height is 29" nominal, including levellers, including levellers
- Available in all standard laminates
- For 3" curved corners add option code "CC" and \$349

**POWER & DATA** For detailed specification, cover code finishes, data and telecom options, and pricing of each electrical modules please refer to page "Power & Data Options".

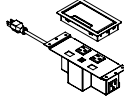
 <p><b>AF2RE</b></p>	<p><b>Finish:</b> Black (BLK), Silver (SLV), White (WHT), Anodized Aluminum (BAA), Stainless Steel (BSS)</p>	 <p><b>AF3AE</b></p>	<p><b>Trim Finish:</b> Black (BLK), Silver (SLV), White (WHT)</p>	 <p><b>AU2FE</b></p>	<p><b>Cover Code:</b> F-AL, F-S, F-B, F-W</p>
	<p><b>Option (Data &amp; Telecom):</b> A, B, C, D, E, F, G, H, J, K</p>		<p><b>Body Finish:</b> White (WHT), Gray (GRY), Black (BLK), Orange (ORN), Red (RED), Green (GRN), Blue (BLU)</p>		<p><b>Option (Data &amp; Telecom):</b> C, K</p>

# Racetrack Nova Table - 2 Base

TNR TT

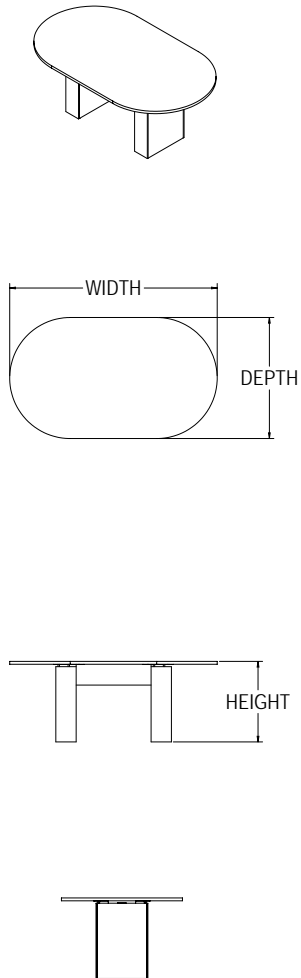

NOMINAL SIZE		TOP	POWER	LAMINATE		
WIDTH	DEPTH	SECTIONS	QUANTITY	PRICE M1	PRICE H1	PRICE K1
60"	30"	1	0	\$2,545	\$2,799	\$3,261
72"	30"	1	0	\$2,546	\$2,800	\$3,263
60"	36"	1	1	\$2,645	\$2,883	\$3,309
72"	36"	1	1	\$2,653	\$2,908	\$3,373
72"	42"	1	1	\$2,655	\$2,909	\$3,374
78"	42"	1	1	\$2,659	\$2,911	\$3,379
84"	42"	1	1	\$2,659	\$2,911	\$3,379
90"	42"	1	1	\$2,661	\$2,914	\$3,384
96"	42"	1	1	\$2,661	\$2,914	\$3,384
108"	42"	2	2	\$2,665	\$2,916	\$3,387
72"	48"	1	1	\$2,658	\$2,910	\$3,376
78"	48"	1	1	\$2,660	\$2,913	\$3,382
84"	48"	1	1	\$2,660	\$2,913	\$3,382
90"	48"	1	1	\$2,663	\$2,915	\$3,385
96"	48"	1	1	\$2,663	\$2,915	\$3,385
108"	48"	2	2	\$2,666	\$2,918	\$3,388
72"	54"	1	1	\$2,768	\$3,020	\$3,488
78"	54"	1	1	\$2,769	\$3,023	\$3,491
84"	54"	1	1	\$2,769	\$3,023	\$3,491
90"	54"	1	1	\$2,771	\$3,024	\$3,496
96"	54"	1	1	\$2,771	\$3,024	\$3,496
108"	54"	2	2	\$2,773	\$3,026	\$3,500
72"	60"	1	1	\$2,768	\$3,020	\$3,488
78"	60"	1	1	\$2,769	\$3,023	\$3,491
84"	60"	1	1	\$2,769	\$3,023	\$3,491
90"	60"	1	1	\$2,771	\$3,024	\$3,496
96"	60"	1	1	\$2,771	\$3,024	\$3,496
108"	60"	2	2	\$2,773	\$3,026	\$3,500

**ORDER CODE SAMPLE**

LINE 1	TABLE	ITEM CODE	WIDTH	DEPTH	LAMINATE
		TNR TT	W96	D48	M1
LINE 1.1	POWER & DATA	POWER OPTION	FINISH / TRIM FINISH / COVER CODE	BODY FINISH / OPTION	POWER QTY
		AF2RE	SLV	D	1

**Features & Specifications**

- Laminate codes - M1: 1" LPL, H1: 1" HPL, K1: 1.25" knife edge (top only)
- Base laminate is 3/4" LPL
- Wire management in each leg
- Height is 29" nominal, including levellers, including levellers
- 108" Wide top is in two sections with seam

**No Charge Options**

- Available in all standard laminates

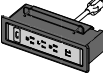
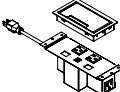
POWER & DATA	For detailed specification, cover code finishes, data and telecom options, and pricing of each electrical modules please refer to page "Power & Data Options".				
<b>AF2RE</b> 	<b>Finish:</b> Black (BLK), Silver (SLV), White (WHT), Anodized Aluminum (BAA), Stainless Steel (BSS)	<b>AF3AE</b> 	<b>Trim Finish:</b> Black (BLK), Silver (SLV), White (WHT)	<b>AU2FE</b> 	<b>Cover Code:</b> F-AL, F-S, F-B, F-W
	<b>Option (Data &amp; Telecom):</b> A, B, C, D, E, F, G, H, J, K		<b>Body Finish:</b> White (WHT), Gray (GRY), Black (BLK), Orange (ORN), Red (RED), Green (GRN), Blue (BLU)		<b>Option (Data &amp; Telecom):</b> C, K

PRODUCT MAP  
CONFERENCE TABLES  
MEDIA TABLES  
PARSONS TABLES  
MEETING & CASUAL TABLES  
NEST TRAINING TABLES  
www.brc.group

# Racetrack Nova Table - 3 Base

TNR TT

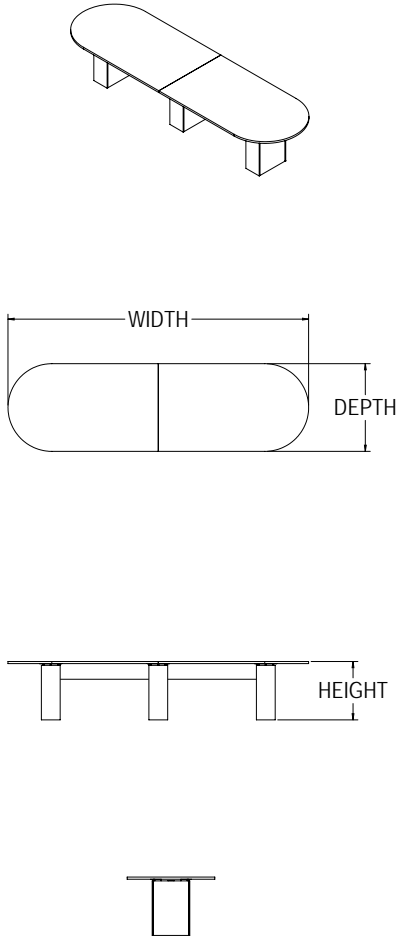

NOMINAL SIZE		TOP	POWER	LAMINATE		
WIDTH	DEPTH	SECTIONS	QUANTITY	PRICE M1	PRICE H1	PRICE K1
120"	42"	2	2	\$3,266	\$3,772	\$4,695
132"	42"	2	2	\$3,268	\$3,775	\$4,700
144"	42"	2	2	\$4,283	\$4,790	\$5,715
156"	42"	2	2	\$4,285	\$4,792	\$5,718
168"	42"	2	2	\$4,288	\$4,795	\$5,724
180"	42"	2	2	\$4,293	\$4,797	\$5,727
192"	42"	2	2	\$4,294	\$4,802	\$5,731
120"	48"	2	2	\$3,267	\$3,773	\$4,696
132"	48"	2	2	\$3,271	\$3,777	\$4,701
144"	48"	2	2	\$4,284	\$4,791	\$5,717
156"	48"	2	2	\$4,286	\$4,793	\$5,723
168"	48"	2	2	\$4,290	\$4,796	\$5,726
180"	48"	2	2	\$4,294	\$4,798	\$5,729
192"	48"	2	2	\$4,295	\$4,803	\$5,734
120"	54"	2	2	\$3,376	\$3,884	\$4,808
132"	54"	2	2	\$3,379	\$3,886	\$4,812
144"	54"	2	2	\$4,447	\$4,953	\$5,881
156"	54"	2	2	\$4,449	\$4,957	\$5,885
168"	54"	2	2	\$4,453	\$4,959	\$5,889
180"	54"	2	2	\$4,456	\$4,962	\$5,892
192"	54"	2	2	\$4,458	\$4,964	\$5,896
120"	60"	2	2	\$3,376	\$3,884	\$4,808
132"	60"	2	2	\$3,379	\$3,886	\$4,812
144"	60"	2	2	\$4,447	\$4,953	\$5,881
156"	60"	2	2	\$4,449	\$4,957	\$5,885
168"	60"	2	2	\$4,453	\$4,959	\$5,889
180"	60"	2	2	\$4,456	\$4,962	\$5,892
192"	60"	2	2	\$4,458	\$4,964	\$5,896

**ORDER CODE SAMPLE**

LINE 1	TABLE	ITEM CODE	WIDTH	DEPTH	LAMINATE
		TNR TT	W144	D48	M1
LINE 1.1	POWER & DATA	POWER OPTION	FINISH / TRIM FINISH / COVER CODE	BODY FINISH / OPTION	POWER QTY
		AF2RE	SLV	D	2

**Features & Specifications**

**No Charge Options**

- Laminate codes - M1: 1" LPL, H1: 1" HPL, K1: 1.25" knife edge (top only)
- Base laminate is 3/4" LPL
- Wire management in each leg
- Height is 29" nominal, including levellers
- Available in all standard laminates

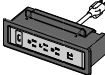
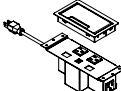
<b>POWER &amp; DATA</b> For detailed specification, cover code finishes, data and telecom options, and pricing of each electrical modules please refer to page "Power & Data Options".					
 <p><b>AF2RE</b></p>	<p><b>Finish:</b> Black (BLK), Silver (SLV), White (WHT), Anodized Aluminum (BAA), Stainless Steel (BSS)</p>	 <p><b>AF3AE</b></p>	<p><b>Trim Finish:</b> Black (BLK), Silver (SLV), White (WHT)</p>	 <p><b>AU2FE</b></p>	<p><b>Cover Code:</b> F-AL, F-S, F-B, F-W</p>
	<p><b>Option (Data &amp; Telecom):</b> A, B, C, D, E, F, G, H, J, K</p>		<p><b>Body Finish:</b> White (WHT), Gray (GRY), Black (BLK), Orange (ORN), Red (RED), Green (GRN), Blue (BLU)</p>		<p><b>Option (Data &amp; Telecom):</b> C, K</p>

PRODUCT MAP  
CONFERENCE TABLES  
MEDIA TABLES  
PARSONS TABLES  
MEETING & CASUAL TABLES  
NEST TRAINING TABLES  
www.brc.group

# Racetrack Nova Table - 4 Base

TNRTT

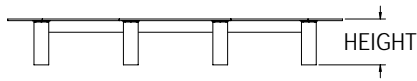
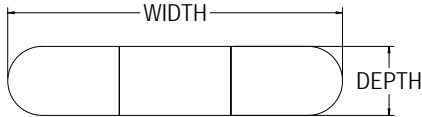
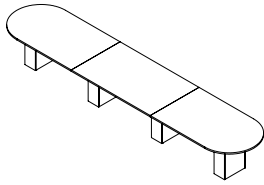

NOMINAL SIZE		TOP	POWER	LAMINATE		
WIDTH	DEPTH	SECTIONS	QUANTITY	PRICE M1	PRICE H1	PRICE K1
204"	42"	3	1, 2, 3	\$5,310	\$5,817	\$6,752
216"	42"	3	1, 2, 3	\$5,310	\$5,817	\$6,752
228"	42"	3	1, 2, 3	\$5,916	\$6,677	\$8,064
240"	42"	3	1, 2, 3	\$5,916	\$6,677	\$8,064
252"	42"	3	1, 2, 3	\$5,928	\$6,686	\$8,080
264"	42"	3	1, 2, 3	\$5,928	\$6,686	\$8,080
276"	42"	3	1, 2, 3	\$5,928	\$6,686	\$8,080
288"	42"	3	1, 2, 3	\$5,928	\$6,686	\$8,080
204"	48"	3	1, 2, 3	\$5,313	\$5,819	\$6,754
216"	48"	3	1, 2, 3	\$5,313	\$5,819	\$6,754
228"	48"	3	1, 2, 3	\$5,917	\$6,678	\$8,066
240"	48"	3	1, 2, 3	\$5,917	\$6,678	\$8,066
252"	48"	3	1, 2, 3	\$5,929	\$6,687	\$8,082
264"	48"	3	1, 2, 3	\$5,929	\$6,687	\$8,082
276"	48"	3	1, 2, 3	\$5,929	\$6,687	\$8,082
288"	48"	3	1, 2, 3	\$5,929	\$6,687	\$8,082
204"	54"	3	1, 2, 3	\$5,527	\$6,036	\$6,972
216"	54"	3	1, 2, 3	\$5,527	\$6,036	\$6,972
228"	54"	3	1, 2, 3	\$6,133	\$6,895	\$8,283
240"	54"	3	1, 2, 3	\$6,133	\$6,895	\$8,283
252"	54"	3	1, 2, 3	\$6,144	\$6,904	\$8,300
264"	54"	3	1, 2, 3	\$6,144	\$6,904	\$8,300
276"	54"	3	1, 2, 3	\$6,144	\$6,904	\$8,300
288"	54"	3	1, 2, 3	\$6,144	\$6,904	\$8,300
204"	60"	3	1, 2, 3	\$5,527	\$6,036	\$6,972
216"	60"	3	1, 2, 3	\$5,527	\$6,036	\$6,972
228"	60"	3	1, 2, 3	\$6,133	\$6,895	\$8,283
240"	60"	3	1, 2, 3	\$6,133	\$6,895	\$8,283
252"	60"	3	1, 2, 3	\$6,144	\$6,904	\$8,300
264"	60"	3	1, 2, 3	\$6,144	\$6,904	\$8,300
276"	60"	3	1, 2, 3	\$6,144	\$6,904	\$8,300
288"	60"	3	1, 2, 3	\$6,144	\$6,904	\$8,300

**ORDER CODE SAMPLE**

LINE 1	TABLE	ITEM CODE	WIDTH	DEPTH	LAMINATE
		TNRTT	W276	D48	M1
LINE 1.1	POWER & DATA	POWER OPTION	FINISH / TRIM FINISH / COVER CODE	BODY FINISH / OPTION	POWER QTY
		AF2RE	SLV	D	1

**Features & Specifications**

**No Charge Options**

- Laminate codes - M1: 1" LPL, H1: 1" HPL, K1: 1.25" knife edge (top only)
- Base laminate is 3/4" LPL
- Wire management in each leg
- Height is 29" nominal, including levellers
- Available in all standard laminates

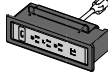
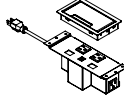
POWER & DATA	For detailed specification, cover code finishes, data and telecom options, and pricing of each electrical modules please refer to page "Power & Data Options".				
<b>AF2RE</b> 	<b>Finish:</b> Black (BLK), Silver (SLV), White (WHT), Anodized Aluminum (BAA), Stainless Steel (BSS)	<b>AF3AE</b> 	<b>Trim Finish:</b> Black (BLK), Silver (SLV), White (WHT)	<b>AU2FE</b> 	<b>Cover Code:</b> F-AL, F-S, F-B, F-W
	<b>Option (Data &amp; Telecom):</b> A, B, C, D, E, F, G, H, J, K		<b>Body Finish:</b> White (WHT), Gray (GRY), Black (BLK), Orange (ORN), Red (RED), Green (GRN), Blue (BLU)		<b>Option (Data &amp; Telecom):</b> C, K

# Arced Boat Nova Table - 2 Base

TNRBT

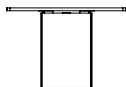
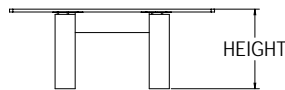
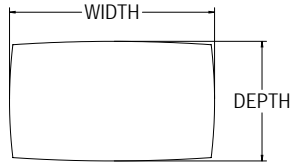
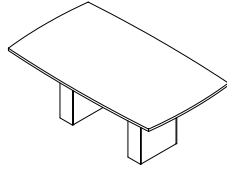

NOMINAL SIZE		TOP	POWER	LAMINATE		
WIDTH	DEPTH	SECTIONS	QUANTITY	PRICE M1	PRICE H1	PRICE K1
60"	30"	1	0	\$2,545	\$2,799	\$3,261
72"	30"	1	0	\$2,546	\$2,800	\$3,263
60"	36"	1	1	\$2,645	\$2,883	\$3,309
72"	36"	1	1	\$2,653	\$2,908	\$3,373
72"	42"	1	1	\$2,655	\$2,909	\$3,374
78"	42"	1	1	\$2,659	\$2,911	\$3,379
84"	42"	1	1	\$2,659	\$2,911	\$3,379
90"	42"	1	1	\$2,661	\$2,914	\$3,384
96"	42"	1	1	\$2,661	\$2,914	\$3,384
108"	42"	2	2	\$2,665	\$2,916	\$3,387
72"	48"	1	1	\$2,658	\$2,910	\$3,376
78"	48"	1	1	\$2,660	\$2,913	\$3,382
84"	48"	1	1	\$2,660	\$2,913	\$3,382
90"	48"	1	1	\$2,663	\$2,915	\$3,385
96"	48"	1	1	\$2,663	\$2,915	\$3,385
108"	48"	2	2	\$2,666	\$2,918	\$3,388
72"	54"	1	1	\$2,768	\$3,020	\$3,488
78"	54"	1	1	\$2,769	\$3,023	\$3,491
84"	54"	1	1	\$2,769	\$3,023	\$3,491
90"	54"	1	1	\$2,771	\$3,024	\$3,496
96"	54"	1	1	\$2,771	\$3,024	\$3,496
108"	54"	2	2	\$2,773	\$3,026	\$3,500
72"	60"	1	1	\$2,768	\$3,020	\$3,488
78"	60"	1	1	\$2,769	\$3,023	\$3,491
84"	60"	1	1	\$2,769	\$3,023	\$3,491
90"	60"	1	1	\$2,771	\$3,024	\$3,496
96"	60"	1	1	\$2,771	\$3,024	\$3,496
108"	60"	2	2	\$2,773	\$3,026	\$3,500

**ORDER CODE SAMPLE**

LINE 1	TABLE	ITEM CODE	WIDTH	DEPTH	LAMINATE	OPTION
		TNRBT	W96	D48	M1	CC
LINE 1.1	POWER & DATA	POWER OPTION	FINISH / TRIM FINISH / COVER CODE	BODY FINISH / OPTION	POWER QTY	
		AF2RE	SLV	D	1	

**Features & Specifications**

No Charge Options  
Optional Extra

- Laminate codes - M1: 1" LPL, H1: 1" HPL, K1: 1.25" knife edge (top only)
- Base laminate is 3/4" LPL
- Wire management in each leg
- Height is 29" nominal, including levellers
- 108" Wide top is in two sections with seam
- Available in all standard laminates
- For 3" curved corners add option code "CC" and \$349

**POWER & DATA** For detailed specification, cover code finishes, data and telecom options, and pricing of each electrical modules please refer to page "Power & Data Options".

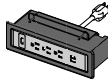
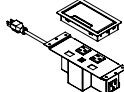
 <p><b>AF2RE</b></p>	<p><b>Finish:</b> Black (BLK), Silver (SLV), White (WHT), Anodized Aluminum (BAA), Stainless Steel (BSS)</p>	 <p><b>AF3AE</b></p>	<p><b>Trim Finish:</b> Black (BLK), Silver (SLV), White (WHT)</p>	 <p><b>AU2FE</b></p>	<p><b>Cover Code:</b> F-AL, F-S, F-B, F-W</p>
	<p><b>Option (Data &amp; Telecom):</b> A, B, C, D, E, F, G, H, J, K</p>		<p><b>Body Finish:</b> White (WHT), Gray (GRY), Black (BLK), Orange (ORN), Red (RED), Green (GRN), Blue (BLU)</p>		<p><b>Option (Data &amp; Telecom):</b> C, K</p>

PRODUCT MAP  
CONFERENCE TABLES  
MEDIA TABLES  
PARSONS TABLES  
MEETING & CASUAL TABLES  
NEST TRAINING TABLES  
www.brc.group

# Arced Boat Nova Table - 3 Base

TNRBT

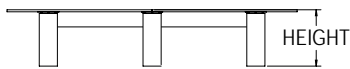
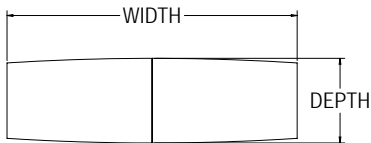
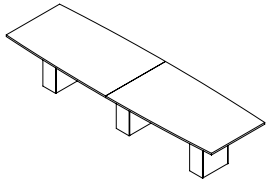

NOMINAL SIZE		TOP	POWER	LAMINATE		
WIDTH	DEPTH	SECTIONS	QUANTITY	PRICE M1	PRICE H1	PRICE K1
120"	42"	2	2	\$3,266	\$3,772	\$4,695
132"	42"	2	2	\$3,268	\$3,775	\$4,700
144"	42"	2	2	\$4,283	\$4,790	\$5,715
156"	42"	2	2	\$4,285	\$4,792	\$5,718
168"	42"	2	2	\$4,288	\$4,795	\$5,724
180"	42"	2	2	\$4,293	\$4,797	\$5,727
192"	42"	2	2	\$4,294	\$4,802	\$5,731
120"	48"	2	2	\$3,267	\$3,773	\$4,696
132"	48"	2	2	\$3,271	\$3,777	\$4,701
144"	48"	2	2	\$4,284	\$4,791	\$5,717
156"	48"	2	2	\$4,286	\$4,793	\$5,723
168"	48"	2	2	\$4,290	\$4,796	\$5,726
180"	48"	2	2	\$4,294	\$4,798	\$5,729
192"	48"	2	2	\$4,295	\$4,803	\$5,734
120"	54"	2	2	\$3,376	\$3,884	\$4,808
132"	54"	2	2	\$3,379	\$3,886	\$4,812
144"	54"	2	2	\$4,447	\$4,953	\$5,881
156"	54"	2	2	\$4,449	\$4,957	\$5,885
168"	54"	2	2	\$4,453	\$4,959	\$5,889
180"	54"	2	2	\$4,456	\$4,962	\$5,892
192"	54"	2	2	\$4,458	\$4,964	\$5,896
120"	60"	2	2	\$3,376	\$3,884	\$4,808
132"	60"	2	2	\$3,379	\$3,886	\$4,812
144"	60"	2	2	\$4,447	\$4,953	\$5,881
156"	60"	2	2	\$4,449	\$4,957	\$5,885
168"	60"	2	2	\$4,453	\$4,959	\$5,889
180"	60"	2	2	\$4,456	\$4,962	\$5,892
192"	60"	2	2	\$4,458	\$4,964	\$5,896

**ORDER CODE SAMPLE**

LINE 1	TABLE	ITEM CODE	WIDTH	DEPTH	LAMINATE	OPTION
		TNRBT	W144	D48	M1	CC
LINE 1.1	POWER & DATA	POWER OPTION	FINISH / TRIM FINISH / COVER CODE	BODY FINISH / OPTION	POWER QTY	
		AF2RE	SLV	D	2	

**Features & Specifications**

No Charge Options  
Optional Extra

- Laminate codes - M1: 1" LPL, H1: 1" HPL, K1: 1.25" knife edge (top only)
- Base laminate is 3/4" LPL
- Wire management in each leg
- Height is 29" nominal, including levellers
- Available in all standard laminates
- For 3" curved corners add option code "CC" and \$349

**POWER & DATA** For detailed specification, cover code finishes, data and telecom options, and pricing of each electrical modules please refer to page "Power & Data Options".

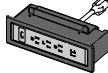
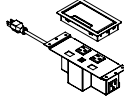
 <p><b>AF2RE</b></p>	<p><b>Finish:</b> Black (BLK), Silver (SLV), White (WHT), Anodized Aluminum (BAA), Stainless Steel (BSS)</p>	 <p><b>AF3AE</b></p>	<p><b>Trim Finish:</b> Black (BLK), Silver (SLV), White (WHT)</p>	 <p><b>AU2FE</b></p>	<p><b>Cover Code:</b> F-AL, F-S, F-B, F-W</p>
	<p><b>Option (Data &amp; Telecom):</b> A, B, C, D, E, F, G, H, J, K</p>		<p><b>Body Finish:</b> White (WHT), Gray (GRY), Black (BLK), Orange (ORN), Red (RED), Green (GRN), Blue (BLU)</p>		<p><b>Option (Data &amp; Telecom):</b> C, K</p>

PRODUCT MAP  
CONFERENCE TABLES  
MEDIA TABLES  
PARSONS TABLES  
MEETING & CASUAL TABLES  
NEST TRAINING TABLES  
www.brc.group

# Arced Boat Nova Table - 4 Base

TNRBT

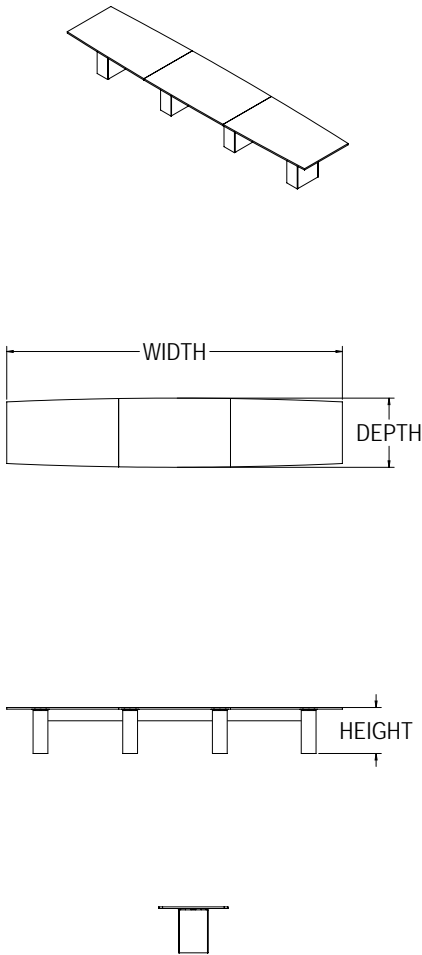

NOMINAL SIZE		TOP	POWER	LAMINATE		
WIDTH	DEPTH	SECTIONS	QUANTITY	PRICE M1	PRICE H1	PRICE K1
204"	42"	3	1, 2, 3	\$5,310	\$5,817	\$6,752
216"	42"	3	1, 2, 3	\$5,310	\$5,817	\$6,752
228"	42"	3	1, 2, 3	\$5,916	\$6,677	\$8,064
240"	42"	3	1, 2, 3	\$5,916	\$6,677	\$8,064
252"	42"	3	1, 2, 3	\$5,928	\$6,686	\$8,080
264"	42"	3	1, 2, 3	\$5,928	\$6,686	\$8,080
276"	42"	3	1, 2, 3	\$5,928	\$6,686	\$8,080
288"	42"	3	1, 2, 3	\$5,928	\$6,686	\$8,080
204"	48"	3	1, 2, 3	\$5,313	\$5,819	\$6,754
216"	48"	3	1, 2, 3	\$5,313	\$5,819	\$6,754
228"	48"	3	1, 2, 3	\$5,917	\$6,678	\$8,066
240"	48"	3	1, 2, 3	\$5,917	\$6,678	\$8,066
252"	48"	3	1, 2, 3	\$5,929	\$6,687	\$8,082
264"	48"	3	1, 2, 3	\$5,929	\$6,687	\$8,082
276"	48"	3	1, 2, 3	\$5,929	\$6,687	\$8,082
288"	48"	3	1, 2, 3	\$5,929	\$6,687	\$8,082
204"	54"	3	1, 2, 3	\$5,527	\$6,036	\$6,972
216"	54"	3	1, 2, 3	\$5,527	\$6,036	\$6,972
228"	54"	3	1, 2, 3	\$6,133	\$6,895	\$8,283
240"	54"	3	1, 2, 3	\$6,133	\$6,895	\$8,283
252"	54"	3	1, 2, 3	\$6,144	\$6,904	\$8,300
264"	54"	3	1, 2, 3	\$6,144	\$6,904	\$8,300
276"	54"	3	1, 2, 3	\$6,144	\$6,904	\$8,300
288"	54"	3	1, 2, 3	\$6,144	\$6,904	\$8,300
204"	60"	3	1, 2, 3	\$5,527	\$6,036	\$6,972
216"	60"	3	1, 2, 3	\$5,527	\$6,036	\$6,972
228"	60"	3	1, 2, 3	\$6,133	\$6,895	\$8,283
240"	60"	3	1, 2, 3	\$6,133	\$6,895	\$8,283
252"	60"	3	1, 2, 3	\$6,144	\$6,904	\$8,300
264"	60"	3	1, 2, 3	\$6,144	\$6,904	\$8,300
276"	60"	3	1, 2, 3	\$6,144	\$6,904	\$8,300
288"	60"	3	1, 2, 3	\$6,144	\$6,904	\$8,300

**ORDER CODE SAMPLE**

LINE 1	TABLE	ITEM CODE	WIDTH	DEPTH	LAMINATE	OPTION
		TNRBT	W276	D48	M1	CC
LINE 1.1	POWER & DATA	POWER OPTION	FINISH / TRIM FINISH / COVER CODE	BODY FINISH / OPTION	POWER QTY	
		AF2RE	SLV	D	1	

**Features & Specifications**

No Charge Options  
Optional Extra

- Laminate codes - M1: 1" LPL, H1: 1" HPL, K1: 1.25" knife edge (top only)
- Base laminate is 3/4" LPL
- Wire management in each leg
- Height is 29" nominal, including levellers
- Available in all standard laminates
- For 3" curved corners add option code "CC" and \$349

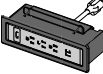
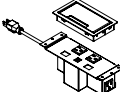
POWER & DATA	For detailed specification, cover code finishes, data and telecom options, and pricing of each electrical modules please refer to page "Power & Data Options".				
 <p><b>AF2RE</b></p> <p><b>Finish:</b> Black (BLK), Silver (SLV), White (WHT), Anodized Aluminum (BAA), Stainless Steel (BSS)</p> <p><b>Option (Data &amp; Telecom):</b> A, B, C, D, E, F, G, H, J, K</p>	 <p><b>AF3AE</b></p> <p><b>Trim Finish:</b> Black (BLK), Silver (SLV), White (WHT)</p> <p><b>Body Finish:</b> White (WHT), Gray (GRY), Black (BLK), Orange (ORN), Red (RED), Green (GRN), Blue (BLU)</p>	 <p><b>AU2FE</b></p> <p><b>Cover Code:</b> F-AL, F-S, F-B, F-W</p> <p><b>Option (Data &amp; Telecom):</b> C, K</p>			

PRODUCT MAP  
CONFERENCE TABLES  
MEDIA TABLES  
PARSONS TABLES  
MEETING & CASUAL TABLES  
NEST TRAINING TABLES  
www.brc.group

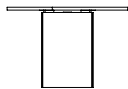
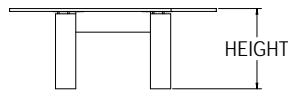
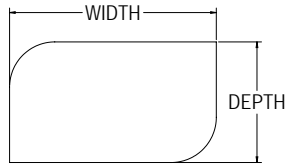
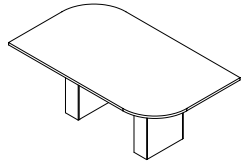

NOMINAL SIZE		TOP	POWER	LAMINATE		
WIDTH	DEPTH	SECTIONS	QUANTITY	PRICE M1	PRICE H1	PRICE K1
60"	30"	1	0	\$2,545	\$2,799	\$3,261
72"	30"	1	0	\$2,546	\$2,800	\$3,263
60"	36"	1	1	\$2,645	\$2,883	\$3,309
72"	36"	1	1	\$2,653	\$2,908	\$3,373
72"	42"	1	1	\$2,655	\$2,909	\$3,374
78"	42"	1	1	\$2,659	\$2,911	\$3,379
84"	42"	1	1	\$2,659	\$2,911	\$3,379
90"	42"	1	1	\$2,661	\$2,914	\$3,384
96"	42"	1	1	\$2,661	\$2,914	\$3,384
108"	42"	2	2	\$2,665	\$2,916	\$3,387
72"	48"	1	1	\$2,658	\$2,910	\$3,376
78"	48"	1	1	\$2,660	\$2,913	\$3,382
84"	48"	1	1	\$2,660	\$2,913	\$3,382
90"	48"	1	1	\$2,663	\$2,915	\$3,385
96"	48"	1	1	\$2,663	\$2,915	\$3,385
108"	48"	2	2	\$2,666	\$2,918	\$3,388
72"	54"	1	1	\$2,768	\$3,020	\$3,488
78"	54"	1	1	\$2,769	\$3,023	\$3,491
84"	54"	1	1	\$2,769	\$3,023	\$3,491
90"	54"	1	1	\$2,771	\$3,024	\$3,496
96"	54"	1	1	\$2,771	\$3,024	\$3,496
108"	54"	2	2	\$2,773	\$3,026	\$3,500
72"	60"	1	1	\$2,768	\$3,020	\$3,488
78"	60"	1	1	\$2,769	\$3,023	\$3,491
84"	60"	1	1	\$2,769	\$3,023	\$3,491
90"	60"	1	1	\$2,771	\$3,024	\$3,496
96"	60"	1	1	\$2,771	\$3,024	\$3,496
108"	60"	2	2	\$2,773	\$3,026	\$3,500

**ORDER CODE SAMPLE**

LINE 1	TABLE	ITEM CODE	WIDTH	DEPTH	LAMINATE
		TNRCT	W96	D48	M1
LINE 1.1	POWER & DATA	POWER OPTION	FINISH / TRIM FINISH / COVER CODE	BODY FINISH / OPTION	POWER QTY
		AF2RE	SLV	D	1

**Features & Specifications**

- Laminate codes - M1: 1" LPL, H1: 1" HPL, K1: 1.25" knife edge (top only)
- Base laminate is 3/4" LPL
- Wire management in each leg
- Height is 29" nominal, including levelers
- 108" Wide top is in two sections with seam
- Available in all standard laminates

**No Charge Options**

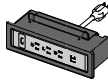
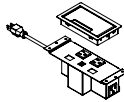
POWER & DATA	For detailed specification, cover code finishes, data and telecom options, and pricing of each electrical modules please refer to page "Power & Data Options".				
<b>AF2RE</b> 	<b>Finish:</b> Black (BLK), Silver (SLV), White (WHT), Anodized Aluminum (BAA), Stainless Steel (BSS)	<b>AF3AE</b> 	<b>Trim Finish:</b> Black (BLK), Silver (SLV), White (WHT)	<b>AU2FE</b> 	<b>Cover Code:</b> F-AL, F-S, F-B, F-W
	<b>Option (Data &amp; Telecom):</b> A, B, C, D, E, F, G, H, J, K		<b>Body Finish:</b> White (WHT), Gray (GRY), Black (BLK), Orange (ORN), Red (RED), Green (GRN), Blue (BLU)		<b>Option (Data &amp; Telecom):</b> C, K

PRODUCT MAP  
CONFERENCE TABLES  
MEDIA TABLES  
PARSONS TABLES  
MEETING & CASUAL TABLES  
NEST TRAINING TABLES  
www.brc.group

# BRC Nova Table - 3 Base

TNRCT

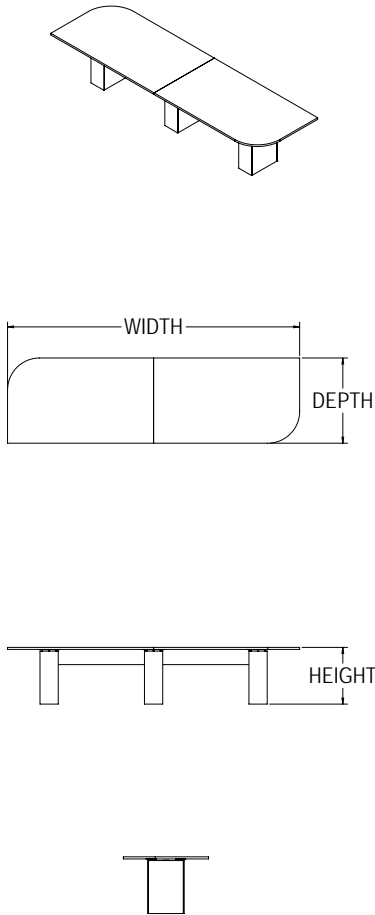

NOMINAL SIZE		TOP	POWER	LAMINATE		
WIDTH	DEPTH	SECTIONS	QUANTITY	PRICE M1	PRICE H1	PRICE K1
120"	42"	2	2	\$3,266	\$3,772	\$4,695
132"	42"	2	2	\$3,268	\$3,775	\$4,700
144"	42"	2	2	\$4,283	\$4,790	\$5,715
156"	42"	2	2	\$4,285	\$4,792	\$5,718
168"	42"	2	2	\$4,288	\$4,795	\$5,724
180"	42"	2	2	\$4,293	\$4,797	\$5,727
192"	42"	2	2	\$4,294	\$4,802	\$5,731
120"	48"	2	2	\$3,267	\$3,773	\$4,696
132"	48"	2	2	\$3,271	\$3,777	\$4,701
144"	48"	2	2	\$4,284	\$4,791	\$5,717
156"	48"	2	2	\$4,286	\$4,793	\$5,723
168"	48"	2	2	\$4,290	\$4,796	\$5,726
180"	48"	2	2	\$4,294	\$4,798	\$5,729
192"	48"	2	2	\$4,295	\$4,803	\$5,734
120"	54"	2	2	\$3,376	\$3,884	\$4,808
132"	54"	2	2	\$3,379	\$3,886	\$4,812
144"	54"	2	2	\$4,447	\$4,953	\$5,881
156"	54"	2	2	\$4,449	\$4,957	\$5,885
168"	54"	2	2	\$4,453	\$4,959	\$5,889
180"	54"	2	2	\$4,456	\$4,962	\$5,892
192"	54"	2	2	\$4,458	\$4,964	\$5,896
120"	60"	2	2	\$3,376	\$3,884	\$4,808
132"	60"	2	2	\$3,379	\$3,886	\$4,812
144"	60"	2	2	\$4,447	\$4,953	\$5,881
156"	60"	2	2	\$4,449	\$4,957	\$5,885
168"	60"	2	2	\$4,453	\$4,959	\$5,889
180"	60"	2	2	\$4,456	\$4,962	\$5,892
192"	60"	2	2	\$4,458	\$4,964	\$5,896

**ORDER CODE SAMPLE**

LINE 1	TABLE	ITEM CODE	WIDTH	DEPTH	LAMINATE
		TNRCT	W144	D48	M1
LINE 1.1	POWER & DATA	POWER OPTION	FINISH / TRIM FINISH / COVER CODE	BODY FINISH / OPTION	POWER QTY
		AF2RE	SLV	D	2

**Features & Specifications**

**No Charge Options**

- Laminate codes - M1: 1" LPL, H1: 1" HPL, K1: 1.25" knife edge (top only)
- Base laminate is 3/4" LPL
- Wire management in each leg
- Height is 29" nominal, including levellers
- Available in all standard laminates

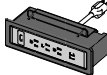
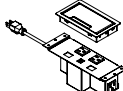
<b>POWER &amp; DATA</b> For detailed specification, cover code finishes, data and telecom options, and pricing of each electrical modules please refer to page "Power & Data Options".					
 <p><b>AF2RE</b></p>	<p><b>Finish:</b> Black (BLK), Silver (SLV), White (WHT), Anodized Aluminum (BAA), Stainless Steel (BSS)</p>	 <p><b>AF3AE</b></p>	<p><b>Trim Finish:</b> Black (BLK), Silver (SLV), White (WHT)</p>	 <p><b>AU2FE</b></p>	<p><b>Cover Code:</b> F-AL, F-S, F-B, F-W</p>
	<p><b>Option (Data &amp; Telecom):</b> A, B, C, D, E, F, G, H, J, K</p>		<p><b>Body Finish:</b> White (WHT), Gray (GRY), Black (BLK), Orange (ORN), Red (RED), Green (GRN), Blue (BLU)</p>		<p><b>Option (Data &amp; Telecom):</b> C, K</p>

PRODUCT MAP  
CONFERENCE TABLES  
MEDIA TABLES  
PARSONS TABLES  
MEETING & CASUAL TABLES  
NEST TRAINING TABLES  
www.brc.group

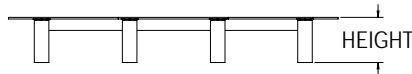
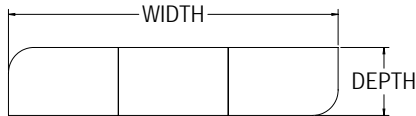
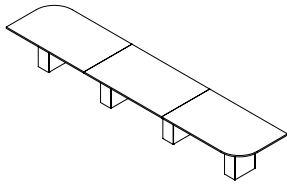

NOMINAL SIZE		TOP	POWER	LAMINATE		
WIDTH	DEPTH	SECTIONS	QUANTITY	PRICE M1	PRICE H1	PRICE K1
204"	42"	3	1, 2, 3	\$5,310	\$5,817	\$6,752
216"	42"	3	1, 2, 3	\$5,310	\$5,817	\$6,752
228"	42"	3	1, 2, 3	\$5,916	\$6,677	\$8,064
240"	42"	3	1, 2, 3	\$5,916	\$6,677	\$8,064
252"	42"	3	1, 2, 3	\$5,928	\$6,686	\$8,080
264"	42"	3	1, 2, 3	\$5,928	\$6,686	\$8,080
276"	42"	3	1, 2, 3	\$5,928	\$6,686	\$8,080
288"	42"	3	1, 2, 3	\$5,928	\$6,686	\$8,080
204"	48"	3	1, 2, 3	\$5,313	\$5,819	\$6,754
216"	48"	3	1, 2, 3	\$5,313	\$5,819	\$6,754
228"	48"	3	1, 2, 3	\$5,917	\$6,678	\$8,066
240"	48"	3	1, 2, 3	\$5,917	\$6,678	\$8,066
252"	48"	3	1, 2, 3	\$5,929	\$6,687	\$8,082
264"	48"	3	1, 2, 3	\$5,929	\$6,687	\$8,082
276"	48"	3	1, 2, 3	\$5,929	\$6,687	\$8,082
288"	48"	3	1, 2, 3	\$5,929	\$6,687	\$8,082
204"	54"	3	1, 2, 3	\$5,527	\$6,036	\$6,972
216"	54"	3	1, 2, 3	\$5,527	\$6,036	\$6,972
228"	54"	3	1, 2, 3	\$6,133	\$6,895	\$8,283
240"	54"	3	1, 2, 3	\$6,133	\$6,895	\$8,283
252"	54"	3	1, 2, 3	\$6,144	\$6,904	\$8,300
264"	54"	3	1, 2, 3	\$6,144	\$6,904	\$8,300
276"	54"	3	1, 2, 3	\$6,144	\$6,904	\$8,300
288"	54"	3	1, 2, 3	\$6,144	\$6,904	\$8,300
204"	60"	3	1, 2, 3	\$5,527	\$6,036	\$6,972
216"	60"	3	1, 2, 3	\$5,527	\$6,036	\$6,972
228"	60"	3	1, 2, 3	\$6,133	\$6,895	\$8,283
240"	60"	3	1, 2, 3	\$6,133	\$6,895	\$8,283
252"	60"	3	1, 2, 3	\$6,144	\$6,904	\$8,300
264"	60"	3	1, 2, 3	\$6,144	\$6,904	\$8,300
276"	60"	3	1, 2, 3	\$6,144	\$6,904	\$8,300
288"	60"	3	1, 2, 3	\$6,144	\$6,904	\$8,300

**ORDER CODE SAMPLE**

LINE 1	TABLE	ITEM CODE	WIDTH	DEPTH	LAMINATE
		TNRCT	W276	D48	M1
LINE 1.1	POWER & DATA	POWER OPTION	FINISH / TRIM FINISH / COVER CODE	BODY FINISH / OPTION	POWER QTY
		AF2RE	SLV	D	1

**Features & Specifications**

**No Charge Options**

- Laminate codes - M1: 1" LPL, H1: 1" HPL, K1: 1.25" knife edge (top only)
- Base laminate is 3/4" LPL
- Wire management in each leg
- Height is 29" nominal, including levellers
- Available in all standard laminates

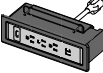
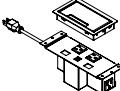
<b>POWER &amp; DATA</b> For detailed specification, cover code finishes, data and telecom options, and pricing of each electrical modules please refer to page "Power & Data Options".					
 <p><b>AF2RE</b></p>	<p><b>Finish:</b> Black (BLK), Silver (SLV), White (WHT), Anodized Aluminum (BAA), Stainless Steel (BSS)</p>	 <p><b>AF3AE</b></p>	<p><b>Trim Finish:</b> Black (BLK), Silver (SLV), White (WHT)</p>	 <p><b>AU2FE</b></p>	<p><b>Cover Code:</b> F-AL, F-S, F-B, F-W</p>
	<p><b>Option (Data &amp; Telecom):</b> A, B, C, D, E, F, G, H, J, K</p>		<p><b>Body Finish:</b> White (WHT), Gray (GRY), Black (BLK), Orange (ORN), Red (RED), Green (GRN), Blue (BLU)</p>		<p><b>Option (Data &amp; Telecom):</b> C, K</p>

PRODUCT MAP  
CONFERENCE TABLES  
MEDIA TABLES  
PARSONS TABLES  
MEETING & CASUAL TABLES  
NEST TRAINING TABLES  
www.brc.group

# Trapezoid Nova Table - 2 Base

TNRZT

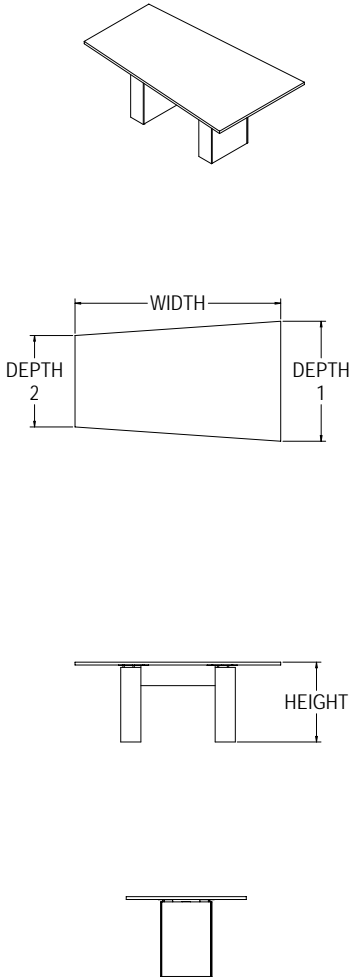

NOMINAL SIZE			TOP	POWER	LAMINATE		
WIDTH	DEPTH 1	DEPTH 2	SECTIONS	QUANTITY	PRICE M1	PRICE H1	PRICE K1
72"	42"	36"	1	1	\$2,655	\$2,909	\$3,374
78"	42"	36"	1	1	\$2,659	\$2,911	\$3,379
84"	42"	36"	1	1	\$2,659	\$2,911	\$3,379
90"	42"	36"	1	1	\$2,661	\$2,914	\$3,384
96"	42"	36"	1	1	\$2,661	\$2,914	\$3,384
108"	42"	36"	2	2	\$2,665	\$2,916	\$3,387
72"	48"	38"	1	1	\$2,658	\$2,910	\$3,376
78"	48"	38"	1	1	\$2,660	\$2,913	\$3,382
84"	48"	38"	1	1	\$2,660	\$2,913	\$3,382
90"	48"	38"	1	1	\$2,663	\$2,915	\$3,385
96"	48"	38"	1	1	\$2,663	\$2,915	\$3,385
108"	48"	38"	2	2	\$2,666	\$2,918	\$3,388
72"	54"	44"	1	1	\$2,768	\$3,020	\$3,488
78"	54"	44"	1	1	\$2,769	\$3,023	\$3,491
84"	54"	44"	1	1	\$2,769	\$3,023	\$3,491
90"	54"	44"	1	1	\$2,771	\$3,024	\$3,496
96"	54"	44"	1	1	\$2,771	\$3,024	\$3,496
108"	54"	44"	2	2	\$2,773	\$3,026	\$3,500
72"	60"	50"	1	1	\$2,768	\$3,020	\$3,488
78"	60"	50"	1	1	\$2,769	\$3,023	\$3,491
84"	60"	50"	1	1	\$2,769	\$3,023	\$3,491
90"	60"	50"	1	1	\$2,771	\$3,024	\$3,496
96"	60"	50"	1	1	\$2,771	\$3,024	\$3,496
108"	60"	50"	2	2	\$2,773	\$3,026	\$3,500

**ORDER CODE SAMPLE**

LINE 1	TABLE	ITEM CODE	WIDTH	DEPTH 1	DEPTH 2	LAMINATE	OPTION
		TNRZT	W96	D48	D38	M1	CC
LINE 1.1	POWER & DATA	POWER OPTION	FINISH / TRIM FINISH / COVER CODE	BODY FINISH / OPTION		POWER QTY	
		AF2RE	SLV	D		1	

**Features & Specifications**

No Charge Options  
Optional Extra

- Laminate codes - M1: 1" LPL, H1: 1" HPL, K1: 1.25" knife edge (top only)
- Base laminate is 3/4" LPL
- Wire management in each leg
- Height is 29" nominal, including levelers
- 108" Wide top is in two sections with seam
- Available in all standard laminates
- For 3" curved corners add option code "CC" and \$349

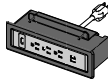
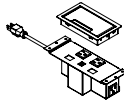
POWER & DATA	For detailed specification, cover code finishes, data and telecom options, and pricing of each electrical modules please refer to page "Power & Data Options".				
<b>AF2RE</b> 	<b>Finish:</b> Black (BLK), Silver (SLV), White (WHT), Anodized Aluminum (BAA), Stainless Steel (BSS)	<b>AF3AE</b> 	<b>Trim Finish:</b> Black (BLK), Silver (SLV), White (WHT)	<b>AU2FE</b> 	<b>Cover Code:</b> F-AL, F-S, F-B, F-W
	<b>Option (Data &amp; Telecom):</b> A, B, C, D, E, F, G, H, J, K		<b>Body Finish:</b> White (WHT), Gray (GRY), Black (BLK), Orange (ORN), Red (RED), Green (GRN), Blue (BLU)		<b>Option (Data &amp; Telecom):</b> C, K

# Trapezoid Nova Table - 3 Base

TNRZT

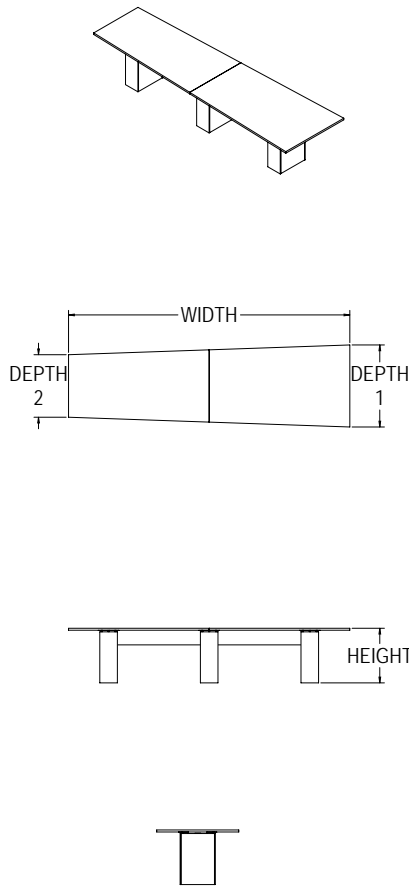

NOMINAL SIZE			TOP	POWER	LAMINATE		
WIDTH	DEPTH 1	DEPTH 2	SECTIONS	QUANTITY	PRICE M1	PRICE H1	PRICE K1
120"	42"	36"	2	2	\$3,266	\$3,772	\$4,695
132"	42"	36"	2	2	\$3,268	\$3,775	\$4,700
144"	42"	36"	2	2	\$4,283	\$4,790	\$5,715
156"	42"	36"	2	2	\$4,285	\$4,792	\$5,718
168"	42"	36"	2	2	\$4,288	\$4,795	\$5,724
180"	42"	36"	2	2	\$4,293	\$4,797	\$5,727
192"	42"	36"	2	2	\$4,294	\$4,802	\$5,731
120"	48"	38"	2	2	\$3,267	\$3,773	\$4,696
132"	48"	38"	2	2	\$3,271	\$3,777	\$4,701
144"	48"	38"	2	2	\$4,284	\$4,791	\$5,717
156"	48"	38"	2	2	\$4,286	\$4,793	\$5,723
168"	48"	38"	2	2	\$4,290	\$4,796	\$5,726
180"	48"	38"	2	2	\$4,294	\$4,798	\$5,729
192"	48"	38"	2	2	\$4,295	\$4,803	\$5,734
120"	54"	44"	2	2	\$3,376	\$3,884	\$4,808
132"	54"	44"	2	2	\$3,379	\$3,886	\$4,812
144"	54"	44"	2	2	\$4,447	\$4,953	\$5,881
156"	54"	44"	2	2	\$4,449	\$4,957	\$5,885
168"	54"	44"	2	2	\$4,453	\$4,959	\$5,889
180"	54"	44"	2	2	\$4,456	\$4,962	\$5,892
192"	54"	44"	2	2	\$4,458	\$4,964	\$5,896
120"	60"	50"	2	2	\$3,376	\$3,884	\$4,808
132"	60"	50"	2	2	\$3,379	\$3,886	\$4,812
144"	60"	50"	2	2	\$4,447	\$4,953	\$5,881
156"	60"	50"	2	2	\$4,449	\$4,957	\$5,885
168"	60"	50"	2	2	\$4,453	\$4,959	\$5,889
180"	60"	50"	2	2	\$4,456	\$4,962	\$5,892
192"	60"	50"	2	2	\$4,458	\$4,964	\$5,896

**ORDER CODE SAMPLE**

LINE 1	TABLE	ITEM CODE	WIDTH	DEPTH 1	DEPTH 2	LAMINATE	OPTION
		TNRZT	W144	D48	D38	M1	CC
LINE 1.1	POWER & DATA	POWER OPTION	FINISH / TRIM FINISH / COVER CODE	BODY FINISH / OPTION		POWER QTY	
		AF2RE	SLV	D		2	

**Features & Specifications**

No Charge Options  
Optional Extra

- Laminate codes - M1: 1" LPL, H1: 1" HPL, K1: 1.25" knife edge (top only)
- Base laminate is 3/4" LPL
- Wire management in each leg
- Height is 29" nominal, including levellers
- Available in all standard laminates
- For 3" curved corners add option code "CC" and \$349

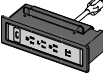
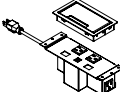
POWER & DATA	For detailed specification, cover code finishes, data and telecom options, and pricing of each electrical modules please refer to page "Power & Data Options".				
<b>AF2RE</b> 	<b>Finish:</b> Black (BLK), Silver (SLV), White (WHT), Anodized Aluminum (BAA), Stainless Steel (BSS)	<b>AF3AE</b> 	<b>Trim Finish:</b> Black (BLK), Silver (SLV), White (WHT)	<b>AU2FE</b> 	<b>Cover Code:</b> F-AL, F-S, F-B, F-W
	<b>Option (Data &amp; Telecom):</b> A, B, C, D, E, F, G, H, J, K		<b>Body Finish:</b> White (WHT), Gray (GRY), Black (BLK), Orange (ORN), Red (RED), Green (GRN), Blue (BLU)		<b>Option (Data &amp; Telecom):</b> C, K

PRODUCT MAP  
CONFERENCE TABLES  
MEDIA TABLES  
PARSONS TABLES  
MEETING & CASUAL TABLES  
NEST TRAINING TABLES  
www.brc.group

# Trapezoid Nova Table - 4 Base

TNRZT

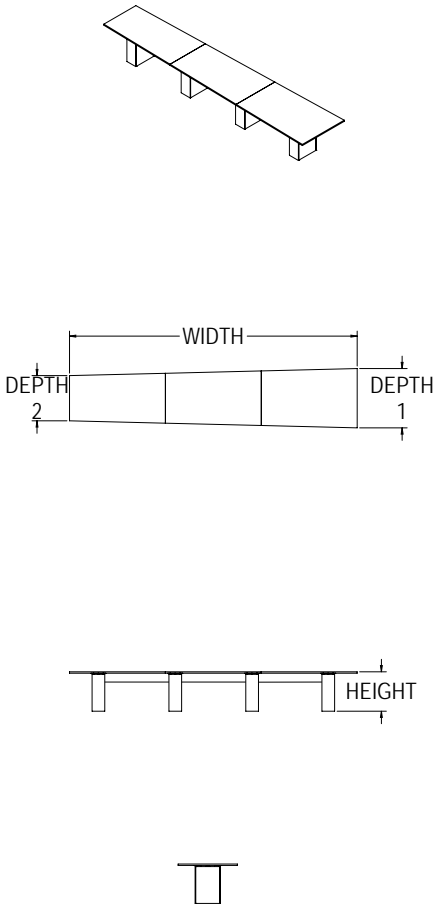

NOMINAL SIZE			TOP	POWER	LAMINATE		
WIDTH	DEPTH 1	DEPTH 2	SECTIONS	QUANTITY	PRICE M1	PRICE H1	PRICE K1
204"	42"	36"	3	1, 2, 3	\$5,310	\$5,817	\$6,752
216"	42"	36"	3	1, 2, 3	\$5,310	\$5,817	\$6,752
228"	42"	36"	3	1, 2, 3	\$5,916	\$6,677	\$8,064
240"	42"	36"	3	1, 2, 3	\$5,916	\$6,677	\$8,064
252"	42"	36"	3	1, 2, 3	\$5,928	\$6,686	\$8,080
264"	42"	36"	3	1, 2, 3	\$5,928	\$6,686	\$8,080
276"	42"	36"	3	1, 2, 3	\$5,928	\$6,686	\$8,080
288"	42"	36"	3	1, 2, 3	\$5,928	\$6,686	\$8,080
204"	48"	38"	3	1, 2, 3	\$5,313	\$5,819	\$6,754
216"	48"	38"	3	1, 2, 3	\$5,313	\$5,819	\$6,754
228"	48"	38"	3	1, 2, 3	\$5,917	\$6,678	\$8,066
240"	48"	38"	3	1, 2, 3	\$5,917	\$6,678	\$8,066
252"	48"	38"	3	1, 2, 3	\$5,929	\$6,687	\$8,082
264"	48"	38"	3	1, 2, 3	\$5,929	\$6,687	\$8,082
276"	48"	38"	3	1, 2, 3	\$5,929	\$6,687	\$8,082
288"	48"	38"	3	1, 2, 3	\$5,929	\$6,687	\$8,082
204"	54"	44"	3	1, 2, 3	\$5,527	\$6,036	\$6,972
216"	54"	44"	3	1, 2, 3	\$5,527	\$6,036	\$6,972
228"	54"	44"	3	1, 2, 3	\$6,133	\$6,895	\$8,283
240"	54"	44"	3	1, 2, 3	\$6,133	\$6,895	\$8,283
252"	54"	44"	3	1, 2, 3	\$6,144	\$6,904	\$8,300
264"	54"	44"	3	1, 2, 3	\$6,144	\$6,904	\$8,300
276"	54"	44"	3	1, 2, 3	\$6,144	\$6,904	\$8,300
288"	54"	44"	3	1, 2, 3	\$6,144	\$6,904	\$8,300
204"	60"	50"	3	1, 2, 3	\$5,527	\$6,036	\$6,972
216"	60"	50"	3	1, 2, 3	\$5,527	\$6,036	\$6,972
228"	60"	50"	3	1, 2, 3	\$6,133	\$6,895	\$8,283
240"	60"	50"	3	1, 2, 3	\$6,133	\$6,895	\$8,283
252"	60"	50"	3	1, 2, 3	\$6,144	\$6,904	\$8,300
264"	60"	50"	3	1, 2, 3	\$6,144	\$6,904	\$8,300
276"	60"	50"	3	1, 2, 3	\$6,144	\$6,904	\$8,300
288"	60"	50"	3	1, 2, 3	\$6,144	\$6,904	\$8,300

**ORDER CODE SAMPLE**

LINE 1	TABLE	ITEM CODE	WIDTH	DEPTH 1	DEPTH 2	LAMINATE	OPTION
		TNRZT	W276	D48	D38	M1	CC
LINE 1.1	POWER & DATA	POWER OPTION	FINISH / TRIM FINISH / COVER CODE	BODY FINISH / OPTION		POWER QTY	
		AF2RE	SLV	D		1	

**Features & Specifications**

No Charge Options  
Optional Extra

- Laminate codes - M1: 1" LPL, H1: 1" HPL, K1: 1.25" knife edge (top only)
- Base laminate is 3/4" LPL
- Wire management in each leg
- Height is 29" nominal, including levellers
- Available in all standard laminates
- For 3" curved corners add option code "CC" and \$349

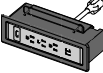
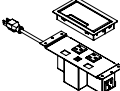
POWER & DATA	For detailed specification, cover code finishes, data and telecom options, and pricing of each electrical modules please refer to page "Power & Data Options".				
<b>AF2RE</b> 	<b>Finish:</b> Black (BLK), Silver (SLV), White (WHT), Anodized Aluminum (BAA), Stainless Steel (BSS)	<b>AF3AE</b> 	<b>Trim Finish:</b> Black (BLK), Silver (SLV), White (WHT)	<b>AU2FE</b> 	<b>Cover Code:</b> F-AL, F-S, F-B, F-W
	<b>Option (Data &amp; Telecom):</b> A, B, C, D, E, F, G, H, J, K		<b>Body Finish:</b> White (WHT), Gray (GRY), Black (BLK), Orange (ORN), Red (RED), Green (GRN), Blue (BLU)		<b>Option (Data &amp; Telecom):</b> C, K

PRODUCT MAP  
CONFERENCE TABLES  
MEDIA TABLES  
PARSONS TABLES  
MEETING & CASUAL TABLES  
NEST TRAINING TABLES  
www.brc.group

# Oval Nova Table - 2 Base

TNROT

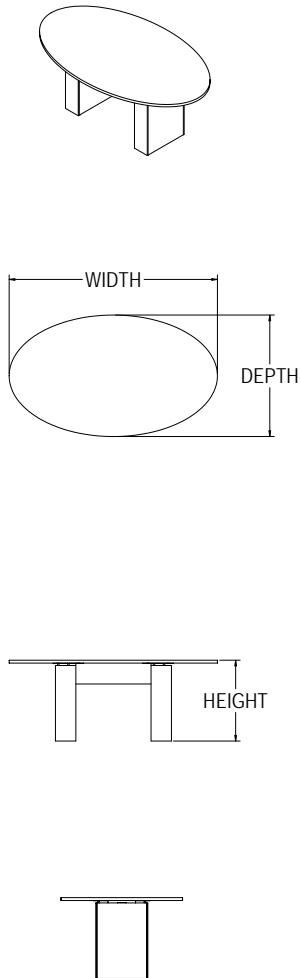

NOMINAL SIZE		TOP	POWER	LAMINATE		
WIDTH	DEPTH	SECTIONS	QUANTITY	PRICE M1	PRICE H1	PRICE K1
60"	30"	1	0	\$2,545	\$2,799	\$3,261
72"	30"	1	0	\$2,546	\$2,800	\$3,263
60"	36"	1	1	\$2,645	\$2,883	\$3,309
72"	36"	1	1	\$2,653	\$2,908	\$3,373
72"	42"	1	1	\$2,655	\$2,909	\$3,374
78"	42"	1	1	\$2,659	\$2,911	\$3,379
84"	42"	1	1	\$2,659	\$2,911	\$3,379
90"	42"	1	1	\$2,661	\$2,914	\$3,384
96"	42"	1	1	\$2,661	\$2,914	\$3,384
108"	42"	2	2	\$2,665	\$2,916	\$3,387
120"	42"	2	2	\$3,266	\$3,772	\$4,695
132"	42"	2	2	\$3,268	\$3,775	\$4,700
72"	48"	1	1	\$2,658	\$2,910	\$3,376
78"	48"	1	1	\$2,660	\$2,913	\$3,382
84"	48"	1	1	\$2,660	\$2,913	\$3,382
90"	48"	1	1	\$2,663	\$2,915	\$3,385
96"	48"	1	1	\$2,663	\$2,915	\$3,385
108"	48"	2	2	\$2,666	\$2,918	\$3,388
120"	48"	2	2	\$3,267	\$3,773	\$4,696
132"	48"	2	2	\$3,271	\$3,777	\$4,701
72"	54"	1	1	\$2,768	\$3,020	\$3,488
78"	54"	1	1	\$2,769	\$3,023	\$3,491
84"	54"	1	1	\$2,769	\$3,023	\$3,491
90"	54"	1	1	\$2,771	\$3,024	\$3,496
96"	54"	1	1	\$2,771	\$3,024	\$3,496
108"	54"	2	2	\$2,773	\$3,026	\$3,500
120"	54"	2	2	\$3,376	\$3,884	\$4,808
132"	54"	2	2	\$3,379	\$3,886	\$4,812
72"	60"	1	1	\$2,768	\$3,020	\$3,488
78"	60"	1	1	\$2,769	\$3,023	\$3,491
84"	60"	1	1	\$2,769	\$3,023	\$3,491
90"	60"	1	1	\$2,771	\$3,024	\$3,496
96"	60"	1	1	\$2,771	\$3,024	\$3,496
108"	60"	2	2	\$2,773	\$3,026	\$3,500
120"	60"	2	2	\$3,376	\$3,884	\$4,808
132"	60"	2	2	\$3,379	\$3,886	\$4,812

**ORDER CODE SAMPLE**

LINE 1	TABLE	ITEM CODE	WIDTH	DEPTH	LAMINATE
		TNROT	W96	D48	M1
LINE 1.1	POWER & DATA	POWER OPTION	FINISH / TRIM FINISH / COVER CODE	BODY FINISH / OPTION	POWER QTY
		AF2RE	SLV	D	1

**Features & Specifications**

- Laminate codes - M1: 1" LPL, H1: 1" HPL, K1: 1.25" knife edge (top only)
- Base laminate is 3/4" LPL
- Wire management in each leg
- Height is 29" nominal, including levellers
- 108" Wide top and larger is in two sections with seam
- Available in all standard laminates

**No Charge Options**

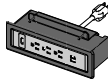
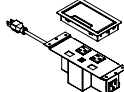
POWER & DATA	For detailed specification, cover code finishes, data and telecom options, and pricing of each electrical modules please refer to page "Power & Data Options".				
<b>AF2RE</b> 	<b>Finish:</b> Black (BLK), Silver (SLV), White (WHT), Anodized Aluminum (BAA), Stainless Steel (BSS)	<b>AF3AE</b> 	<b>Trim Finish:</b> Black (BLK), Silver (SLV), White (WHT)	<b>AU2FE</b> 	<b>Cover Code:</b> F-AL, F-S, F-B, F-W
	<b>Option (Data &amp; Telecom):</b> A, B, C, D, E, F, G, H, J, K		<b>Body Finish:</b> White (WHT), Gray (GRY), Black (BLK), Orange (ORN), Red (RED), Green (GRN), Blue (BLU)		<b>Option (Data &amp; Telecom):</b> C, K

# Oval Nova Table - 3 Base

TNROT

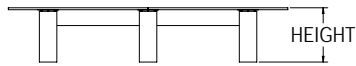
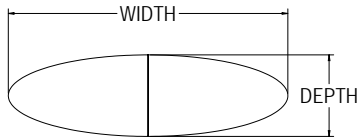
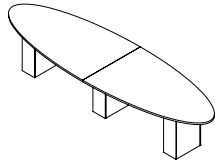

NOMINAL SIZE		TOP	POWER	LAMINATE		
WIDTH	DEPTH	SECTIONS	QUANTITY	PRICE M1	PRICE H1	PRICE K1
144"	42"	2	2	\$4,283	\$4,790	\$5,715
144"	48"	2	2	\$4,284	\$4,791	\$5,717
144"	54"	2	2	\$4,447	\$4,953	\$5,881
144"	60"	2	2	\$4,447	\$4,953	\$5,881

**ORDER CODE SAMPLE**

LINE 1	TABLE	ITEM CODE	WIDTH	DEPTH	LAMINATE
		TNROT	W144	D48	M1
LINE 1.1	POWER & DATA	POWER OPTION	FINISH / TRIM FINISH / COVER CODE	BODY FINISH / OPTION	POWER QTY
		AF2RE	SLV	D	2

**Features & Specifications**

No Charge Options

- Laminate codes - M1: 1" LPL, H1: 1" HPL, K1: 1.25" knife edge (top only)
- Base laminate is 3/4" LPL
- Wire management in each leg
- Height is 29" nominal, including levellers
- Available in all standard laminates

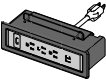
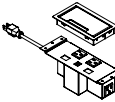
POWER & DATA					
For detailed specification, cover code finishes, data and telecom options, and pricing of each electrical modules please refer to page "Power & Data Options".					
<b>AF2RE</b> 	<b>Finish:</b> Black (BLK), Silver (SLV), White (WHT), Anodized Aluminum (BAA), Stainless Steel (BSS)	<b>AF3AE</b> 	<b>Trim Finish:</b> Black (BLK), Silver (SLV), White (WHT)	<b>AU2FE</b> 	<b>Cover Code:</b> F-AL, F-S, F-B, F-W
	<b>Option (Data &amp; Telecom):</b> A, B, C, D, E, F, G, H, J, K		<b>Body Finish:</b> White (WHT), Gray (GRY), Black (BLK), Orange (ORN), Red (RED), Green (GRN), Blue (BLU)		<b>Option (Data &amp; Telecom):</b> C, K

PRODUCT MAP  
CONFERENCE TABLES  
MEDIA TABLES  
PARSONS TABLES  
MEETING & CASUAL TABLES  
NEST TRAINING TABLES  
www.brc.group

# Rectangular Nova Table - 2 Tri-Base

TNTRT

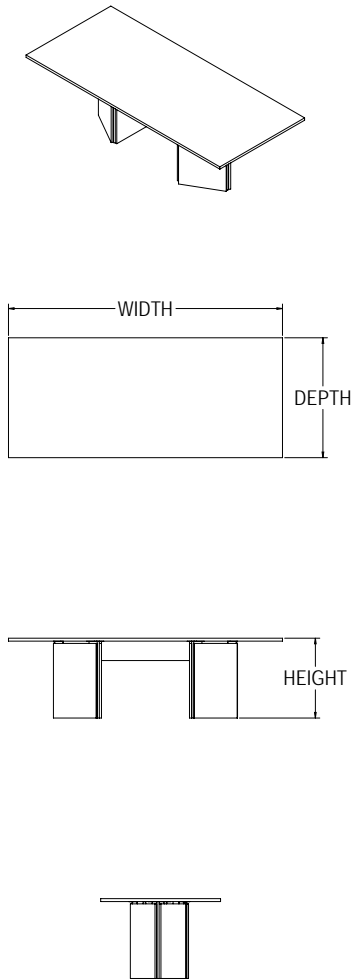

NOMINAL SIZE		TOP	POWER	LAMINATE		
WIDTH	DEPTH	SECTIONS	QUANTITY	PRICE M1	PRICE H1	PRICE K1
96"	42"	1	1	\$3,619	\$3,921	\$4,487
108"	42"	2	2	\$3,634	\$3,939	\$4,493
120"	42"	2	2	\$4,301	\$4,866	\$6,078
132"	42"	2	2	\$4,312	\$4,884	\$6,083
144"	42"	2	2	\$4,327	\$4,902	\$6,089
108"	48"	2	2	\$3,634	\$3,939	\$4,496
120"	48"	2	2	\$4,301	\$4,866	\$6,081
132"	48"	2	2	\$4,312	\$4,884	\$6,086
144"	48"	2	2	\$4,327	\$4,902	\$6,090
108"	54"	2	2	\$3,775	\$4,081	\$4,643
120"	54"	2	2	\$4,442	\$5,008	\$6,228
132"	54"	2	2	\$4,456	\$5,025	\$6,233
144"	54"	2	2	\$4,468	\$5,045	\$6,238
120"	60"	2	2	\$4,442	\$5,008	\$6,228
132"	60"	2	2	\$4,456	\$5,025	\$6,233
144"	60"	2	2	\$4,468	\$5,045	\$6,238

**ORDER CODE SAMPLE**

LINE 1	TABLE	ITEM CODE	WIDTH	DEPTH	LAMINATE	OPTION
		TNTRT	W108	D48	M1	CC
LINE 1.1	POWER & DATA	POWER OPTION	FINISH / TRIM FINISH / COVER CODE	BODY FINISH / OPTION	POWER QTY	
		AF2RE	SLV	D	2	

**Features & Specifications**

No Charge Options  
Optional Extra

- Laminate codes - M1: 1" LPL, H1: 1" HPL, K1: 1.25" knife edge (top only)
- Base laminate is 3/4" LPL
- Wire management in each leg
- Height is 29" nominal, including levellers
- 108" Wide top and larger is in two sections with seam
- Available in all standard laminates and metal finishes
- For 3" curved corners add option code "CC" and \$349

**POWER & DATA** For detailed specification, cover code finishes, data and telecom options, and pricing of each electrical modules please refer to page "Power & Data Options".

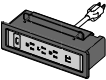
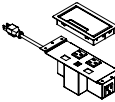
 <p><b>AF2RE</b></p>	<p><b>Finish:</b> Black (BLK), Silver (SLV), White (WHT), Anodized Aluminum (BAA), Stainless Steel (BSS)</p>	 <p><b>AF3AE</b></p>	<p><b>Trim Finish:</b> Black (BLK), Silver (SLV), White (WHT)</p>	 <p><b>AU2FE</b></p>	<p><b>Cover Code:</b> F-AL, F-S, F-B, F-W</p>
	<p><b>Option (Data &amp; Telecom):</b> A, B, C, D, E, F, G, H, J, K</p>		<p><b>Body Finish:</b> White (WHT), Gray (GRY), Black (BLK), Orange (ORN), Red (RED), Green (GRN), Blue (BLU)</p>		<p><b>Option (Data &amp; Telecom):</b> C, K</p>

# Rectangular Nova Table - 3 Tri-Base

TNTRT

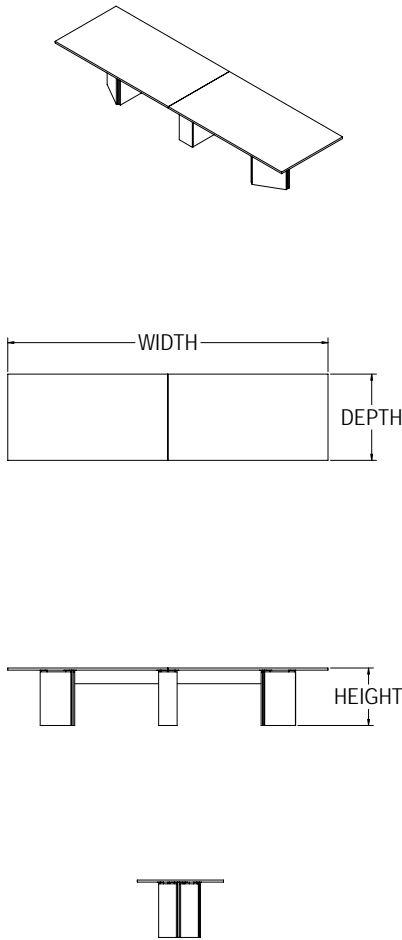

NOMINAL SIZE		TOP	POWER	LAMINATE		
WIDTH	DEPTH	SECTIONS	QUANTITY	PRICE M1	PRICE H1	PRICE K1
156"	42"	2	2	\$5,689	\$6,271	\$7,442
168"	42"	2	2	\$5,703	\$6,290	\$7,446
180"	42"	2	2	\$5,716	\$6,308	\$7,452
192"	42"	2	2	\$5,729	\$6,325	\$7,459
204"	42"	3	1, 2, 3	\$5,756	\$6,364	\$7,467
216"	42"	3	1, 2, 3	\$5,756	\$6,364	\$7,467
228"	42"	3	1, 2, 3	\$6,437	\$7,309	\$9,057
240"	42"	3	1, 2, 3	\$6,437	\$7,309	\$9,057
156"	48"	2	2	\$5,689	\$6,271	\$7,444
168"	48"	2	2	\$5,703	\$6,290	\$7,450
180"	48"	2	2	\$5,716	\$6,308	\$7,456
192"	48"	2	2	\$5,729	\$6,325	\$7,461
204"	48"	3	1, 2, 3	\$5,756	\$6,364	\$7,470
216"	48"	3	1, 2, 3	\$5,756	\$6,364	\$7,470
228"	48"	3	1, 2, 3	\$6,437	\$7,309	\$9,060
240"	48"	3	1, 2, 3	\$6,437	\$7,309	\$9,060
156"	54"	2	2	\$5,903	\$6,483	\$7,663
168"	54"	2	2	\$5,916	\$6,503	\$7,669
180"	54"	2	2	\$5,930	\$6,521	\$7,673
192"	54"	2	2	\$5,942	\$6,540	\$7,678
204"	54"	3	1, 2, 3	\$5,969	\$6,576	\$7,688
216"	54"	3	1, 2, 3	\$5,969	\$6,576	\$7,688
228"	54"	3	1, 2, 3	\$6,648	\$7,521	\$9,279
240"	54"	3	1, 2, 3	\$6,648	\$7,521	\$9,279
156"	60"	2	2	\$5,903	\$6,483	\$7,663
168"	60"	2	2	\$5,916	\$6,503	\$7,669
180"	60"	2	2	\$5,930	\$6,521	\$7,673
192"	60"	2	2	\$5,942	\$6,540	\$7,678
204"	60"	3	1, 2, 3	\$5,969	\$6,576	\$7,688
216"	60"	3	1, 2, 3	\$5,969	\$6,576	\$7,688
228"	60"	3	1, 2, 3	\$6,648	\$7,521	\$9,279
240"	60"	3	1, 2, 3	\$6,648	\$7,521	\$9,279

**ORDER CODE SAMPLE**

LINE 1	TABLE	ITEM CODE	WIDTH	DEPTH	LAMINATE	OPTION
		TNTRT	W204	D48	M1	CC
LINE 1.1	POWER & DATA	POWER OPTION	FINISH / TRIM FINISH / COVER CODE	BODY FINISH / OPTION	POWER QTY	
		AF2RE	SLV	D	1	

**Features & Specifications**

No Charge Options  
Optional Extra

- Laminate codes - M1: 1" LPL, H1: 1" HPL, K1: 1.25" knife edge (top only)
- Base laminate is 3/4" LPL
- Wire management in each leg
- Height is 29" nominal, including levellers
- Available in all standard laminates and metal finishes
- For 3" curved corners add option code "CC" and \$349

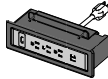
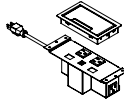
POWER & DATA	For detailed specification, cover code finishes, data and telecom options, and pricing of each electrical modules please refer to page "Power & Data Options".				
<b>AF2RE</b> 	<b>Finish:</b> Black (BLK), Silver (SLV), White (WHT), Anodized Aluminum (BAA), Stainless Steel (BSS)	<b>AF3AE</b> 	<b>Trim Finish:</b> Black (BLK), Silver (SLV), White (WHT)	<b>AU2FE</b> 	<b>Cover Code:</b> F-AL, F-S, F-B, F-W
	<b>Option (Data &amp; Telecom):</b> A, B, C, D, E, F, G, H, J, K		<b>Body Finish:</b> White (WHT), Gray (GRY), Black (BLK), Orange (ORN), Red (RED), Green (GRN), Blue (BLU)		<b>Option (Data &amp; Telecom):</b> C, K

PRODUCT MAP  
CONFERENCE TABLES  
MEDIA TABLES  
PARSONS TABLES  
MEETING & CASUAL TABLES  
NEST TRAINING TABLES  
www.brc.group

# Rectangular Nova Table - 4 Tri-Base

TNTRT

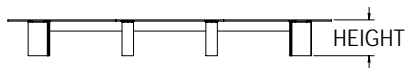
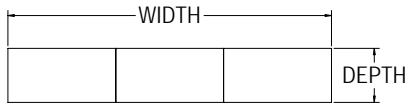
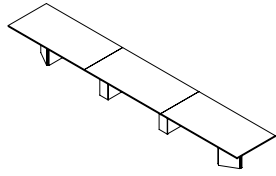

NOMINAL SIZE		TOP	POWER	LAMINATE		
WIDTH	DEPTH	SECTIONS	QUANTITY	PRICE M1	PRICE H1	PRICE K1
252"	42"	3	1, 2, 3	\$7,839	\$8,733	\$10,427
264"	42"	3	1, 2, 3	\$7,839	\$8,733	\$10,427
276"	42"	3	1, 2, 3	\$7,839	\$8,733	\$10,427
288"	42"	3	1, 2, 3	\$7,839	\$8,733	\$10,427
252"	48"	3	1, 2, 3	\$7,839	\$8,733	\$10,431
264"	48"	3	1, 2, 3	\$7,839	\$8,733	\$10,431
276"	48"	3	1, 2, 3	\$7,839	\$8,733	\$10,431
288"	48"	3	1, 2, 3	\$7,839	\$8,733	\$10,431
252"	54"	3	1, 2, 3	\$8,122	\$9,017	\$10,718
264"	54"	3	1, 2, 3	\$8,122	\$9,017	\$10,718
276"	54"	3	1, 2, 3	\$8,122	\$9,017	\$10,718
288"	54"	3	1, 2, 3	\$8,122	\$9,017	\$10,718
252"	60"	3	1, 2, 3	\$8,122	\$9,017	\$10,718
264"	60"	3	1, 2, 3	\$8,122	\$9,017	\$10,718
276"	60"	3	1, 2, 3	\$8,122	\$9,017	\$10,718
288"	60"	3	1, 2, 3	\$8,122	\$9,017	\$10,718

**ORDER CODE SAMPLE**

LINE 1	TABLE	ITEM CODE	WIDTH	DEPTH	LAMINATE	OPTION
		TNTRT	W276	D48	M1	CC
LINE 1.1	POWER & DATA	POWER OPTION	FINISH / TRIM FINISH / COVER CODE	BODY FINISH / OPTION	POWER QTY	
		AF2RE	SLV	D	1	

**Features & Specifications**

No Charge Options  
Optional Extra

- Laminate codes - M1: 1" LPL, H1: 1" HPL, K1: 1.25" knife edge (top only)
- Base laminate is 3/4" LPL
- Wire management in each leg
- Height is 29" nominal, including levellers
- Available in all standard laminates and metal finishes
- For 3" curved corners add option code "CC" and \$349

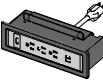
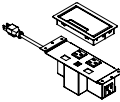
POWER & DATA	For detailed specification, cover code finishes, data and telecom options, and pricing of each electrical modules please refer to page "Power & Data Options".				
<b>AF2RE</b> 	<b>Finish:</b> Black (BLK), Silver (SLV), White (WHT), Anodized Aluminum (BAA), Stainless Steel (BSS)	<b>AF3AE</b> 	<b>Trim Finish:</b> Black (BLK), Silver (SLV), White (WHT)	<b>AU2FE</b> 	<b>Cover Code:</b> F-AL, F-S, F-B, F-W
	<b>Option (Data &amp; Telecom):</b> A, B, C, D, E, F, G, H, J, K		<b>Body Finish:</b> White (WHT), Gray (GRY), Black (BLK), Orange (ORN), Red (RED), Green (GRN), Blue (BLU)		<b>Option (Data &amp; Telecom):</b> C, K

# Boat Shape Nova Table - 2 Tri-Base

TNTAT

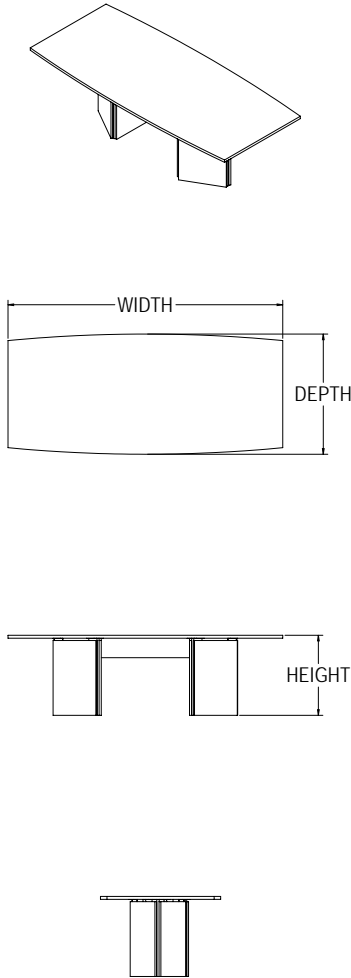

NOMINAL SIZE		TOP	POWER	LAMINATE		
WIDTH	DEPTH	SECTIONS	QUANTITY	PRICE M1	PRICE H1	PRICE K1
96"	42"	1	1	\$3,689	\$4,028	\$4,653
108"	42"	2	2	\$3,692	\$4,030	\$4,657
120"	42"	2	2	\$4,497	\$5,172	\$6,401
132"	42"	2	2	\$4,499	\$5,176	\$6,405
144"	42"	2	2	\$4,503	\$5,179	\$6,413
108"	48"	2	2	\$3,693	\$4,032	\$4,660
120"	48"	2	2	\$4,498	\$5,174	\$6,403
132"	48"	2	2	\$4,502	\$5,178	\$6,410
144"	48"	2	2	\$4,504	\$5,181	\$6,415
108"	54"	2	2	\$3,841	\$4,177	\$4,808
120"	54"	2	2	\$4,644	\$5,320	\$6,551
132"	54"	2	2	\$4,647	\$5,324	\$6,556
144"	54"	2	2	\$4,651	\$5,326	\$6,561
120"	60"	2	2	\$4,644	\$5,320	\$6,551
132"	60"	2	2	\$4,647	\$5,324	\$6,556
144"	60"	2	2	\$4,651	\$5,326	\$6,561

**ORDER CODE SAMPLE**

LINE 1	TABLE	ITEM CODE	WIDTH	DEPTH	LAMINATE	OPTION
		TNTAT	W108	D48	M1	CC
LINE 1.1	POWER & DATA	POWER OPTION	FINISH / TRIM FINISH / COVER CODE	BODY FINISH / OPTION	POWER QTY	
		AF2RE	SLV	D	2	

**Features & Specifications**

No Charge Options  
Optional Extra

- Laminate codes - M1: 1" LPL, H1: 1" HPL, K1: 1.25" knife edge (top only)
- Base laminate is 3/4" LPL
- Wire management in each leg
- Height is 29" nominal, including levellers
- 108" Wide top and larger is in two sections with seam
- Available in all standard laminates and metal finishes
- For 3" curved corners add option code "CC" and \$349

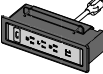
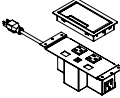
POWER & DATA	For detailed specification, cover code finishes, data and telecom options, and pricing of each electrical modules please refer to page "Power & Data Options".				
<b>AF2RE</b> 	<b>Finish:</b> Black (BLK), Silver (SLV), White (WHT), Anodized Aluminum (BAA), Stainless Steel (BSS)	<b>AF3AE</b> 	<b>Trim Finish:</b> Black (BLK), Silver (SLV), White (WHT)	<b>AU2FE</b> 	<b>Cover Code:</b> F-AL, F-S, F-B, F-W
	<b>Option (Data &amp; Telecom):</b> A, B, C, D, E, F, G, H, J, K		<b>Body Finish:</b> White (WHT), Gray (GRY), Black (BLK), Orange (ORN), Red (RED), Green (GRN), Blue (BLU)		<b>Option (Data &amp; Telecom):</b> C, K

PRODUCT MAP  
CONFERENCE TABLES  
MEDIA TABLES  
PARSONS TABLES  
MEETING & CASUAL TABLES  
NEST TRAINING TABLES  
www.brc.group

# Boat Shape Nova Table - 3 Tri-Base

TNTAT

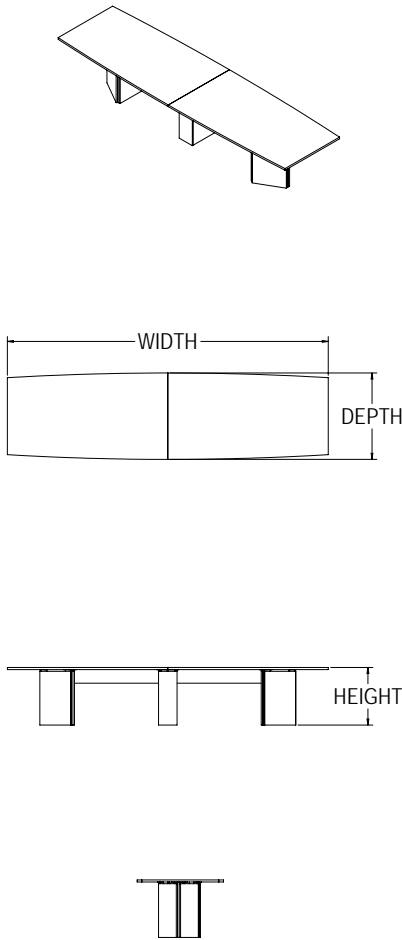

NOMINAL SIZE		TOP	POWER	LAMINATE		
WIDTH	DEPTH	SECTIONS	QUANTITY	PRICE M1	PRICE H1	PRICE K1
156"	42"	2	2	\$5,856	\$6,532	\$7,766
168"	42"	2	2	\$5,859	\$6,534	\$7,772
180"	42"	2	2	\$5,862	\$6,540	\$7,778
192"	42"	2	2	\$5,866	\$6,542	\$7,784
204"	42"	3	1, 2, 3	\$5,875	\$6,548	\$7,795
216"	42"	3	1, 2, 3	\$5,875	\$6,548	\$7,795
228"	42"	3	1, 2, 3	\$6,682	\$7,694	\$9,542
240"	42"	3	1, 2, 3	\$6,682	\$7,694	\$9,542
156"	48"	2	2	\$5,858	\$6,533	\$7,769
168"	48"	2	2	\$5,860	\$6,537	\$7,776
180"	48"	2	2	\$5,865	\$6,541	\$7,782
192"	48"	2	2	\$5,867	\$6,545	\$7,786
204"	48"	3	1, 2, 3	\$5,876	\$6,551	\$7,797
216"	48"	3	1, 2, 3	\$5,876	\$6,551	\$7,797
228"	48"	3	1, 2, 3	\$6,683	\$7,696	\$9,546
240"	48"	3	1, 2, 3	\$6,683	\$7,696	\$9,546
156"	54"	2	2	\$6,073	\$6,750	\$7,988
168"	54"	2	2	\$6,078	\$6,753	\$7,995
180"	54"	2	2	\$6,081	\$6,758	\$8,000
192"	54"	2	2	\$6,084	\$6,760	\$8,005
204"	54"	3	1, 2, 3	\$6,092	\$6,767	\$8,015
216"	54"	3	1, 2, 3	\$6,092	\$6,767	\$8,015
228"	54"	3	1, 2, 3	\$6,899	\$7,913	\$9,766
240"	54"	3	1, 2, 3	\$6,899	\$7,913	\$9,766
156"	60"	2	2	\$6,073	\$6,750	\$7,988
168"	60"	2	2	\$6,078	\$6,753	\$7,995
180"	60"	2	2	\$6,081	\$6,758	\$8,000
192"	60"	2	2	\$6,084	\$6,760	\$8,005
204"	60"	3	1, 2, 3	\$6,092	\$6,767	\$8,015
216"	60"	3	1, 2, 3	\$6,092	\$6,767	\$8,015
228"	60"	3	1, 2, 3	\$6,899	\$7,913	\$9,766
240"	60"	3	1, 2, 3	\$6,899	\$7,913	\$9,766

**ORDER CODE SAMPLE**

LINE 1	TABLE	ITEM CODE	WIDTH	DEPTH	LAMINATE	OPTION
		TNTAT	W204	D48	M1	CC
LINE 1.1	POWER & DATA	POWER OPTION	FINISH / TRIM FINISH / COVER CODE	BODY FINISH / OPTION	POWER QTY	
		AF2RE	SLV	D	1	

**Features & Specifications**

No Charge Options  
Optional Extra

- Laminate codes - M1: 1" LPL, H1: 1" HPL, K1: 1.25" knife edge (top only)
- Base laminate is 3/4" LPL
- Wire management in each leg
- Height is 29" nominal, including levellers
- Available in all standard laminates and metal finishes
- For 3" curved corners add option code "CC" and \$349

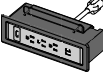
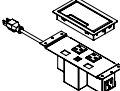
POWER & DATA	For detailed specification, cover code finishes, data and telecom options, and pricing of each electrical modules please refer to page "Power & Data Options".				
<b>AF2RE</b> 	<b>Finish:</b> Black (BLK), Silver (SLV), White (WHT), Anodized Aluminum (BAA), Stainless Steel (BSS)	<b>AF3AE</b> 	<b>Trim Finish:</b> Black (BLK), Silver (SLV), White (WHT)	<b>AU2FE</b> 	<b>Cover Code:</b> F-AL, F-S, F-B, F-W
	<b>Option (Data &amp; Telecom):</b> A, B, C, D, E, F, G, H, J, K		<b>Body Finish:</b> White (WHT), Gray (GRY), Black (BLK), Orange (ORN), Red (RED), Green (GRN), Blue (BLU)		<b>Option (Data &amp; Telecom):</b> C, K

PRODUCT MAP  
CONFERENCE TABLES  
MEDIA TABLES  
PARSONS TABLES  
MEETING & CASUAL TABLES  
NEST TRAINING TABLES  
www.brc.group

# Boat Shape Nova Table - 4 Tri-Base

TNTAT

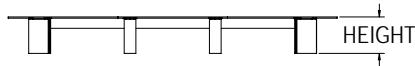
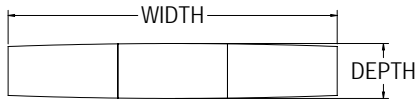
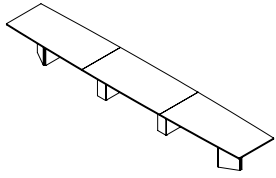

NOMINAL SIZE		TOP	POWER	LAMINATE		
WIDTH	DEPTH	SECTIONS	QUANTITY	PRICE M1	PRICE H1	PRICE K1
252"	42"	3	1, 2, 3	\$8,045	\$9,056	\$10,916
264"	42"	3	1, 2, 3	\$8,045	\$9,056	\$10,916
276"	42"	3	1, 2, 3	\$8,045	\$9,056	\$10,916
288"	42"	3	1, 2, 3	\$8,045	\$9,056	\$10,916
252"	48"	3	1, 2, 3	\$8,046	\$9,057	\$10,918
264"	48"	3	1, 2, 3	\$8,046	\$9,057	\$10,918
276"	48"	3	1, 2, 3	\$8,046	\$9,057	\$10,918
288"	48"	3	1, 2, 3	\$8,046	\$9,057	\$10,918
252"	54"	3	1, 2, 3	\$8,332	\$9,347	\$11,208
264"	54"	3	1, 2, 3	\$8,332	\$9,347	\$11,208
276"	54"	3	1, 2, 3	\$8,332	\$9,347	\$11,208
288"	54"	3	1, 2, 3	\$8,332	\$9,347	\$11,208
252"	60"	3	1, 2, 3	\$8,332	\$9,347	\$11,208
264"	60"	3	1, 2, 3	\$8,332	\$9,347	\$11,208
276"	60"	3	1, 2, 3	\$8,332	\$9,347	\$11,208
288"	60"	3	1, 2, 3	\$8,332	\$9,347	\$11,208

**ORDER CODE SAMPLE**

LINE 1	TABLE	ITEM CODE	WIDTH	DEPTH	LAMINATE	OPTION
		TNTAT	W276	D48	M1	CC
LINE 1.1	POWER & DATA	POWER OPTION	FINISH / TRIM FINISH / COVER CODE	BODY FINISH / OPTION	POWER QTY	
		AF2RE	SLV	D	1	

**Features & Specifications**

No Charge Options  
Optional Extra

- Laminate codes - M1: 1" LPL, H1: 1" HPL, K1: 1.25" knife edge (top only)
- Base laminate is 3/4" LPL
- Wire management in each leg
- Height is 29" nominal, including levellers
- Available in all standard laminates and metal finishes
- For 3" curved corners add option code "CC" and \$349

**POWER & DATA** For detailed specification, cover code finishes, data and telecom options, and pricing of each electrical modules please refer to page "Power & Data Options".

<p><b>AF2RE</b></p>	<p><b>Finish:</b> Black (BLK), Silver (SLV), White (WHT), Anodized Aluminum (BAA), Stainless Steel (BSS)</p>	<p><b>AF3AE</b></p>	<p><b>Trim Finish:</b> Black (BLK), Silver (SLV), White (WHT)</p>	<p><b>AU2FE</b></p>	<p><b>Cover Code:</b> F-AL, F-S, F-B, F-W</p>
	<p><b>Option (Data &amp; Telecom):</b> A, B, C, D, E, F, G, H, J, K</p>		<p><b>Body Finish:</b> White (WHT), Gray (GRY), Black (BLK), Orange (ORN), Red (RED), Green (GRN), Blue (BLU)</p>		

PRODUCT MAP  
CONFERENCE TABLES  
MEDIA TABLES  
PARSONS TABLES  
MEETING & CASUAL TABLES  
NEST TRAINING TABLES  
www.brc.group

# Racetrack Nova Table - 2 Tri-Base

TNTTT

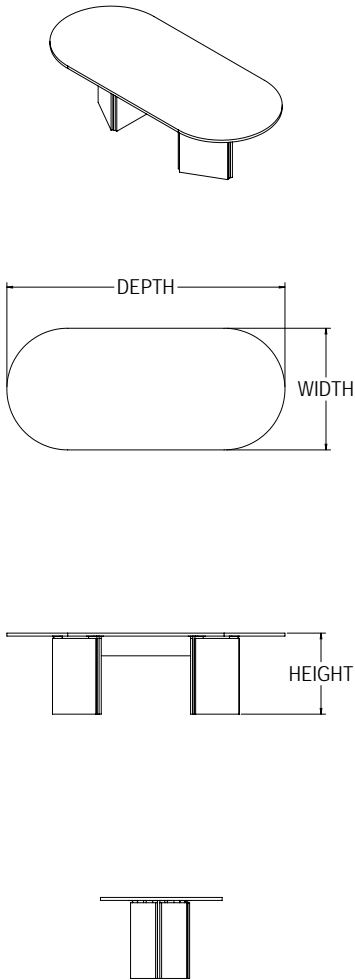

NOMINAL SIZE		TOP	POWER	LAMINATE		
WIDTH	DEPTH	SECTIONS	QUANTITY	PRICE M1	PRICE H1	PRICE K1
96"	42"	1	1	\$3,689	\$4,028	\$4,653
108"	42"	2	2	\$3,692	\$4,030	\$4,657
120"	42"	2	2	\$4,497	\$5,172	\$6,401
132"	42"	2	2	\$4,499	\$5,176	\$6,405
144"	42"	2	2	\$4,503	\$5,179	\$6,413
108"	48"	2	2	\$3,693	\$4,032	\$4,660
120"	48"	2	2	\$4,498	\$5,174	\$6,403
132"	48"	2	2	\$4,502	\$5,178	\$6,410
144"	48"	2	2	\$4,504	\$5,181	\$6,415
108"	54"	2	2	\$3,841	\$4,177	\$4,808
120"	54"	2	2	\$4,644	\$5,320	\$6,551
132"	54"	2	2	\$4,647	\$5,324	\$6,556
144"	54"	2	2	\$4,651	\$5,326	\$6,561
120"	60"	2	2	\$4,644	\$5,320	\$6,551
132"	60"	2	2	\$4,647	\$5,324	\$6,556
144"	60"	2	2	\$4,651	\$5,326	\$6,561

**ORDER CODE SAMPLE**

LINE 1	TABLE	ITEM CODE	WIDTH	DEPTH	LAMINATE
		TNTTT	W108	D48	M1
LINE 1.1	POWER & DATA	POWER OPTION	FINISH / TRIM FINISH / COVER CODE	BODY FINISH / OPTION	POWER QTY
		AF2RE	SLV	D	2

**Features & Specifications**

- Laminate codes - M1: 1" LPL, H1: 1" HPL, K1: 1.25" knife edge (top only)
- Base laminate is 3/4" LPL
- Wire management in each leg
- Height is 29" nominal, including levellers
- 108" Wide top and larger is in two sections with seam
- Available in all standard laminates and metal finishes

**No Charge Options**

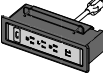
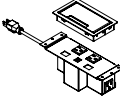
POWER & DATA	For detailed specification, cover code finishes, data and telecom options, and pricing of each electrical modules please refer to page "Power & Data Options".				
<b>AF2RE</b> 	<b>Finish:</b> Black (BLK), Silver (SLV), White (WHT), Anodized Aluminum (BAA), Stainless Steel (BSS)	<b>AF3AE</b> 	<b>Trim Finish:</b> Black (BLK), Silver (SLV), White (WHT)	<b>AU2FE</b> 	<b>Cover Code:</b> F-AL, F-S, F-B, F-W
	<b>Option (Data &amp; Telecom):</b> A, B, C, D, E, F, G, H, J, K		<b>Body Finish:</b> White (WHT), Gray (GRY), Black (BLK), Orange (ORN), Red (RED), Green (GRN), Blue (BLU)		<b>Option (Data &amp; Telecom):</b> C, K

PRODUCT MAP  
CONFERENCE TABLES  
MEDIA TABLES  
PARSONS TABLES  
MEETING & CASUAL TABLES  
NEST TRAINING TABLES  
www.brc.group

# Racetrack Nova Table - 3 Tri-Base

TNTTT

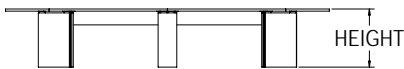
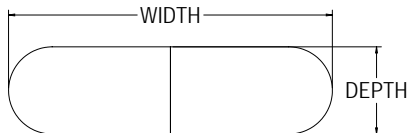
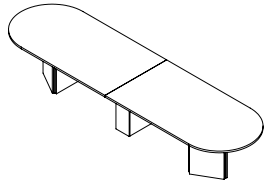

NOMINAL SIZE		TOP	POWER	LAMINATE		
WIDTH	DEPTH	SECTIONS	QUANTITY	PRICE M1	PRICE H1	PRICE K1
156"	42"	2	2	\$5,856	\$6,532	\$7,766
168"	42"	2	2	\$5,859	\$6,534	\$7,772
180"	42"	2	2	\$5,862	\$6,540	\$7,778
192"	42"	2	2	\$5,866	\$6,542	\$7,784
204"	42"	3	1, 2, 3	\$5,875	\$6,548	\$7,795
216"	42"	3	1, 2, 3	\$5,875	\$6,548	\$7,795
228"	42"	3	1, 2, 3	\$6,682	\$7,694	\$9,542
240"	42"	3	1, 2, 3	\$6,682	\$7,694	\$9,542
156"	48"	2	2	\$5,858	\$6,533	\$7,769
168"	48"	2	2	\$5,860	\$6,537	\$7,776
180"	48"	2	2	\$5,865	\$6,541	\$7,782
192"	48"	2	2	\$5,867	\$6,545	\$7,786
204"	48"	3	1, 2, 3	\$5,876	\$6,551	\$7,797
216"	48"	3	1, 2, 3	\$5,876	\$6,551	\$7,797
228"	48"	3	1, 2, 3	\$6,683	\$7,696	\$9,546
240"	48"	3	1, 2, 3	\$6,683	\$7,696	\$9,546
156"	54"	2	2	\$6,073	\$6,750	\$7,988
168"	54"	2	2	\$6,078	\$6,753	\$7,995
180"	54"	2	2	\$6,081	\$6,758	\$8,000
192"	54"	2	2	\$6,084	\$6,760	\$8,005
204"	54"	3	1, 2, 3	\$6,092	\$6,767	\$8,015
216"	54"	3	1, 2, 3	\$6,092	\$6,767	\$8,015
228"	54"	3	1, 2, 3	\$6,899	\$7,913	\$9,766
240"	54"	3	1, 2, 3	\$6,899	\$7,913	\$9,766
156"	60"	2	2	\$6,073	\$6,750	\$7,988
168"	60"	2	2	\$6,078	\$6,753	\$7,995
180"	60"	2	2	\$6,081	\$6,758	\$8,000
192"	60"	2	2	\$6,084	\$6,760	\$8,005
204"	60"	3	1, 2, 3	\$6,092	\$6,767	\$8,015
216"	60"	3	1, 2, 3	\$6,092	\$6,767	\$8,015
228"	60"	3	1, 2, 3	\$6,899	\$7,913	\$9,766
240"	60"	3	1, 2, 3	\$6,899	\$7,913	\$9,766

**ORDER CODE SAMPLE**

LINE 1	TABLE	ITEM CODE	WIDTH	DEPTH	LAMINATE
		TNTTT	W204	D48	M1
LINE 1.1	POWER & DATA	POWER OPTION	FINISH / TRIM FINISH / COVER CODE	BODY FINISH / OPTION	POWER QTY
		AF2RE	SLV	D	1

**Features & Specifications**

**No Charge Options**

- Laminate codes - M1: 1" LPL, H1: 1" HPL, K1: 1.25" knife edge (top only)
- Base laminate is 3/4" LPL
- Wire management in each leg
- Height is 29" nominal, including levellers
- Available in all standard laminates and metal finishes

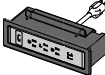
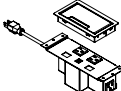
<b>POWER &amp; DATA</b> For detailed specification, cover code finishes, data and telecom options, and pricing of each electrical modules please refer to page "Power & Data Options".					
 <b>AF2RE</b>	<b>Finish:</b> Black (BLK), Silver (SLV), White (WHT), Anodized Aluminum (BAA), Stainless Steel (BSS)	 <b>AF3AE</b>	<b>Trim Finish:</b> Black (BLK), Silver (SLV), White (WHT)	 <b>AU2FE</b>	<b>Cover Code:</b> F-AL, F-S, F-B, F-W
	<b>Option (Data &amp; Telecom):</b> A, B, C, D, E, F, G, H, J, K		<b>Body Finish:</b> White (WHT), Gray (GRY), Black (BLK), Orange (ORN), Red (RED), Green (GRN), Blue (BLU)		<b>Option (Data &amp; Telecom):</b> C, K

PRODUCT MAP  
CONFERENCE TABLES  
MEDIA TABLES  
PARSONS TABLES  
MEETING & CASUAL TABLES  
NEST TRAINING TABLES  
www.brc.group

# Racetrack Nova Table - 4 Tri-Base

TNTTT

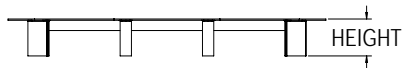
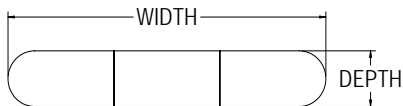
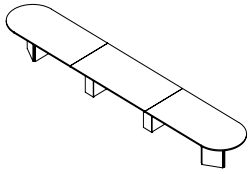

NOMINAL SIZE		TOP	POWER	LAMINATE		
WIDTH	DEPTH	SECTIONS	QUANTITY	PRICE M1	PRICE H1	PRICE K1
252"	42"	3	1, 2, 3	\$8,045	\$9,056	\$10,916
264"	42"	3	1, 2, 3	\$8,045	\$9,056	\$10,916
276"	42"	3	1, 2, 3	\$8,045	\$9,056	\$10,916
288"	42"	3	1, 2, 3	\$8,045	\$9,056	\$10,916
252"	48"	3	1, 2, 3	\$8,046	\$9,057	\$10,918
264"	48"	3	1, 2, 3	\$8,046	\$9,057	\$10,918
276"	48"	3	1, 2, 3	\$8,046	\$9,057	\$10,918
288"	48"	3	1, 2, 3	\$8,046	\$9,057	\$10,918
252"	54"	3	1, 2, 3	\$8,332	\$9,347	\$11,208
264"	54"	3	1, 2, 3	\$8,332	\$9,347	\$11,208
276"	54"	3	1, 2, 3	\$8,332	\$9,347	\$11,208
288"	54"	3	1, 2, 3	\$8,332	\$9,347	\$11,208
252"	60"	3	1, 2, 3	\$8,332	\$9,347	\$11,208
264"	60"	3	1, 2, 3	\$8,332	\$9,347	\$11,208
276"	60"	3	1, 2, 3	\$8,332	\$9,347	\$11,208
288"	60"	3	1, 2, 3	\$8,332	\$9,347	\$11,208

**ORDER CODE SAMPLE**

LINE 1	TABLE	ITEM CODE	WIDTH	DEPTH	LAMINATE
		TNTTT	W276	D48	M1
LINE 1.1	POWER & DATA	POWER OPTION	FINISH / TRIM FINISH / COVER CODE	BODY FINISH / OPTION	POWER QTY
		AF2RE	SLV	D	1

**Features & Specifications**

**No Charge Options**

- Laminate codes - M1: 1" LPL, H1: 1" HPL, K1: 1.25" knife edge (top only)
- Base laminate is 3/4" LPL
- Wire management in each leg
- Height is 29" nominal, including levellers
- Available in all standard laminates and metal finishes

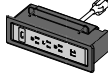
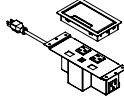
POWER & DATA					
For detailed specification, cover code finishes, data and telecom options, and pricing of each electrical modules please refer to page "Power & Data Options".					
 <p><b>AF2RE</b></p>	<b>Finish:</b> Black (BLK), Silver (SLV), White (WHT), Anodized Aluminum (BAA), Stainless Steel (BSS)	 <p><b>AF3AE</b></p>	<b>Trim Finish:</b> Black (BLK), Silver (SLV), White (WHT)	 <p><b>AU2FE</b></p>	<b>Cover Code:</b> F-AL, F-S, F-B, F-W
	<b>Option (Data &amp; Telecom):</b> A, B, C, D, E, F, G, H, J, K		<b>Body Finish:</b> White (WHT), Gray (GRY), Black (BLK), Orange (ORN), Red (RED), Green (GRN), Blue (BLU)		<b>Option (Data &amp; Telecom):</b> C, K

# Arced Boat Nova Table - 2 Tri-Base

TNTBT

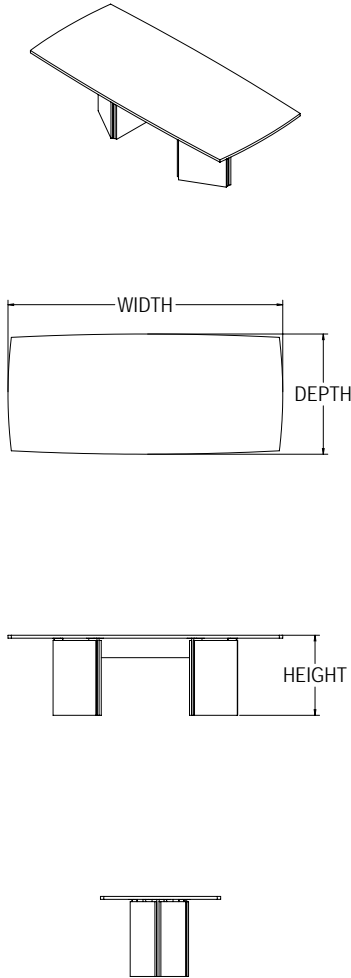

NOMINAL SIZE		TOP	POWER	LAMINATE		
WIDTH	DEPTH	SECTIONS	QUANTITY	PRICE M1	PRICE H1	PRICE K1
96"	42"	1	1	\$3,689	\$4,028	\$4,653
108"	42"	2	2	\$3,692	\$4,030	\$4,657
120"	42"	2	2	\$4,497	\$5,172	\$6,401
132"	42"	2	2	\$4,499	\$5,176	\$6,405
144"	42"	2	2	\$4,503	\$5,179	\$6,413
108"	48"	2	2	\$3,693	\$4,032	\$4,660
120"	48"	2	2	\$4,498	\$5,174	\$6,403
132"	48"	2	2	\$4,502	\$5,178	\$6,410
144"	48"	2	2	\$4,504	\$5,181	\$6,415
108"	54"	2	2	\$3,841	\$4,177	\$4,808
120"	54"	2	2	\$4,644	\$5,320	\$6,551
132"	54"	2	2	\$4,647	\$5,324	\$6,556
144"	54"	2	2	\$4,651	\$5,326	\$6,561
120"	60"	2	2	\$4,644	\$5,320	\$6,551
132"	60"	2	2	\$4,647	\$5,324	\$6,556
144"	60"	2	2	\$4,651	\$5,326	\$6,561

**ORDER CODE SAMPLE**

LINE 1	TABLE	ITEM CODE	WIDTH	DEPTH	LAMINATE	OPTION
		TNTBT	W108	D48	M1	CC
LINE 1.1	POWER & DATA	POWER OPTION	FINISH / TRIM FINISH / COVER CODE	BODY FINISH / OPTION	POWER QTY	
		AF2RE	SLV	D	2	

**Features & Specifications**

No Charge Options  
Optional Extra

- Laminate codes - M1: 1" LPL, H1: 1" HPL, K1: 1.25" knife edge (top only)
- Base laminate is 3/4" LPL
- Wire management in each leg
- Height is 29" nominal, including levellers
- 108" Wide top and larger is in two sections with seam
- Available in all standard laminates and metal finishes
- For 3" curved corners add option code "CC" and \$349

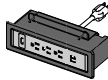
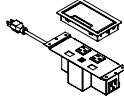
POWER & DATA	For detailed specification, cover code finishes, data and telecom options, and pricing of each electrical modules please refer to page "Power & Data Options".				
<b>AF2RE</b> 	<b>Finish:</b> Black (BLK), Silver (SLV), White (WHT), Anodized Aluminum (BAA), Stainless Steel (BSS)	<b>AF3AE</b> 	<b>Trim Finish:</b> Black (BLK), Silver (SLV), White (WHT)	<b>AU2FE</b> 	<b>Cover Code:</b> F-AL, F-S, F-B, F-W
	<b>Option (Data &amp; Telecom):</b> A, B, C, D, E, F, G, H, J, K		<b>Body Finish:</b> White (WHT), Gray (GRY), Black (BLK), Orange (ORN), Red (RED), Green (GRN), Blue (BLU)		<b>Option (Data &amp; Telecom):</b> C, K

PRODUCT MAP  
CONFERENCE TABLES  
MEDIA TABLES  
PARSONS TABLES  
MEETING & CASUAL TABLES  
NEST TRAINING TABLES  
www.brc.group

# Arced Boat Nova Table - 3 Tri-Base

TNTBT

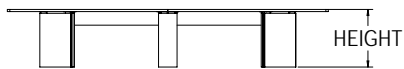
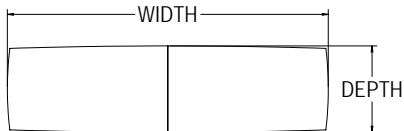
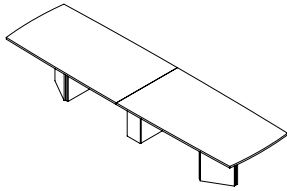

NOMINAL SIZE		TOP	POWER	LAMINATE		
WIDTH	DEPTH	SECTIONS	QUANTITY	PRICE M1	PRICE H1	PRICE K1
156"	42"	2	2	\$5,856	\$6,532	\$7,766
168"	42"	2	2	\$5,859	\$6,534	\$7,772
180"	42"	2	2	\$5,862	\$6,540	\$7,778
192"	42"	2	2	\$5,866	\$6,542	\$7,784
204"	42"	3	1, 2, 3	\$5,875	\$6,548	\$7,795
216"	42"	3	1, 2, 3	\$5,875	\$6,548	\$7,795
228"	42"	3	1, 2, 3	\$6,682	\$7,694	\$9,542
240"	42"	3	1, 2, 3	\$6,682	\$7,694	\$9,542
156"	48"	2	2	\$5,858	\$6,533	\$7,769
168"	48"	2	2	\$5,860	\$6,537	\$7,776
180"	48"	2	2	\$5,865	\$6,541	\$7,782
192"	48"	2	2	\$5,867	\$6,545	\$7,786
204"	48"	3	1, 2, 3	\$5,876	\$6,551	\$7,797
216"	48"	3	1, 2, 3	\$5,876	\$6,551	\$7,797
228"	48"	3	1, 2, 3	\$6,683	\$7,696	\$9,546
240"	48"	3	1, 2, 3	\$6,683	\$7,696	\$9,546
156"	54"	2	2	\$6,073	\$6,750	\$7,988
168"	54"	2	2	\$6,078	\$6,753	\$7,995
180"	54"	2	2	\$6,081	\$6,758	\$8,000
192"	54"	2	2	\$6,084	\$6,760	\$8,005
204"	54"	3	1, 2, 3	\$6,092	\$6,767	\$8,015
216"	54"	3	1, 2, 3	\$6,092	\$6,767	\$8,015
228"	54"	3	1, 2, 3	\$6,899	\$7,913	\$9,766
240"	54"	3	1, 2, 3	\$6,899	\$7,913	\$9,766
156"	60"	2	2	\$6,073	\$6,750	\$7,988
168"	60"	2	2	\$6,078	\$6,753	\$7,995
180"	60"	2	2	\$6,081	\$6,758	\$8,000
192"	60"	2	2	\$6,084	\$6,760	\$8,005
204"	60"	3	1, 2, 3	\$6,092	\$6,767	\$8,015
216"	60"	3	1, 2, 3	\$6,092	\$6,767	\$8,015
228"	60"	3	1, 2, 3	\$6,899	\$7,913	\$9,766
240"	60"	3	1, 2, 3	\$6,899	\$7,913	\$9,766

**ORDER CODE SAMPLE**

LINE 1	TABLE	ITEM CODE	WIDTH	DEPTH	LAMINATE	OPTION
		TNTBT	W204	D48	M1	CC
LINE 1.1	POWER & DATA	POWER OPTION	FINISH / TRIM FINISH / COVER CODE	BODY FINISH / OPTION	POWER QTY	
		AF2RE	SLV	D	1	

**Features & Specifications**

No Charge Options  
Optional Extra

- Laminate codes - M1: 1" LPL, H1: 1" HPL, K1: 1.25" knife edge (top only)
- Base laminate is 3/4" LPL
- Wire management in each leg
- Height is 29" nominal, including levellers
- Available in all standard laminates and metal finishes
- For 3" curved corners add option code "CC" and \$349

**POWER & DATA** For detailed specification, cover code finishes, data and telecom options, and pricing of each electrical modules please refer to page "Power & Data Options".

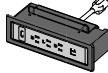
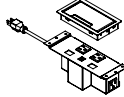
 <p><b>AF2RE</b></p>	<p><b>Finish:</b> Black (BLK), Silver (SLV), White (WHT), Anodized Aluminum (BAA), Stainless Steel (BSS)</p>	 <p><b>AF3AE</b></p>	<p><b>Trim Finish:</b> Black (BLK), Silver (SLV), White (WHT)</p>	 <p><b>AU2FE</b></p>	<p><b>Cover Code:</b> F-AL, F-S, F-B, F-W</p>
	<p><b>Option (Data &amp; Telecom):</b> A, B, C, D, E, F, G, H, J, K</p>		<p><b>Body Finish:</b> White (WHT), Gray (GRY), Black (BLK), Orange (ORN), Red (RED), Green (GRN), Blue (BLU)</p>		<p><b>Option (Data &amp; Telecom):</b> C, K</p>

PRODUCT MAP  
CONFERENCE TABLES  
MEDIA TABLES  
PARSONS TABLES  
MEETING & CASUAL TABLES  
NEST TRAINING TABLES  
www.brc.group

# Arced Boat Nova Table - 4 Tri-Base

TNTBT

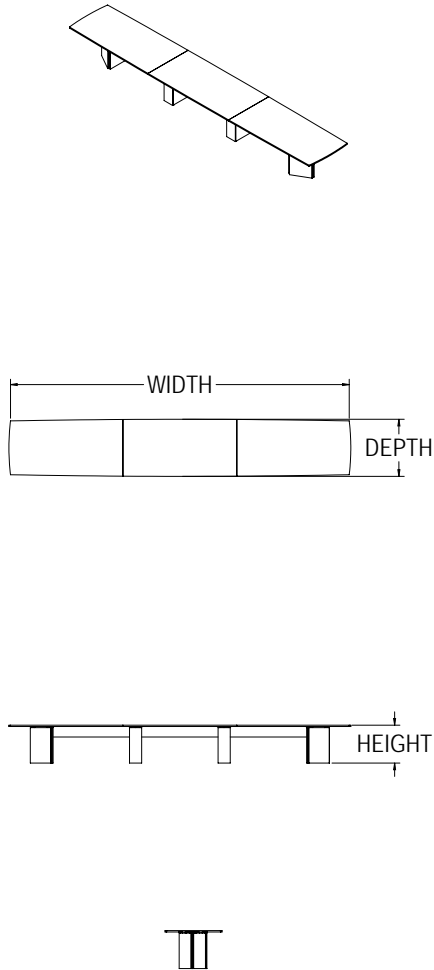

NOMINAL SIZE		TOP	POWER	LAMINATE		
WIDTH	DEPTH	SECTIONS	QUANTITY	PRICE M1	PRICE H1	PRICE K1
252"	42"	3	1, 2, 3	\$8,045	\$9,056	\$10,916
264"	42"	3	1, 2, 3	\$8,045	\$9,056	\$10,916
276"	42"	3	1, 2, 3	\$8,045	\$9,056	\$10,916
288"	42"	3	1, 2, 3	\$8,045	\$9,056	\$10,916
252"	48"	3	1, 2, 3	\$8,046	\$9,057	\$10,918
264"	48"	3	1, 2, 3	\$8,046	\$9,057	\$10,918
276"	48"	3	1, 2, 3	\$8,046	\$9,057	\$10,918
288"	48"	3	1, 2, 3	\$8,046	\$9,057	\$10,918
252"	54"	3	1, 2, 3	\$8,332	\$9,347	\$11,208
264"	54"	3	1, 2, 3	\$8,332	\$9,347	\$11,208
276"	54"	3	1, 2, 3	\$8,332	\$9,347	\$11,208
288"	54"	3	1, 2, 3	\$8,332	\$9,347	\$11,208
252"	60"	3	1, 2, 3	\$8,332	\$9,347	\$11,208
264"	60"	3	1, 2, 3	\$8,332	\$9,347	\$11,208
276"	60"	3	1, 2, 3	\$8,332	\$9,347	\$11,208
288"	60"	3	1, 2, 3	\$8,332	\$9,347	\$11,208

**ORDER CODE SAMPLE**

LINE 1	TABLE	ITEM CODE	WIDTH	DEPTH	LAMINATE	OPTION
		TNTBT	W276	D48	M1	CC
LINE 1.1	POWER & DATA	POWER OPTION	FINISH / TRIM FINISH / COVER CODE	BODY FINISH / OPTION	POWER QTY	
		AF2RE	SLV	D	1	

**Features & Specifications**

No Charge Options  
Optional Extra

- Laminate codes - M1: 1" LPL, H1: 1" HPL, K1: 1.25" knife edge (top only)
- Base laminate is 3/4" LPL
- Wire management in each leg
- Height is 29" nominal, including levellers
- Available in all standard laminates and metal finishes
- For 3" curved corners add option code "CC" and \$349

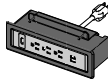
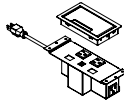
POWER & DATA	For detailed specification, cover code finishes, data and telecom options, and pricing of each electrical modules please refer to page "Power & Data Options".				
<b>AF2RE</b> 	<b>Finish:</b> Black (BLK), Silver (SLV), White (WHT), Anodized Aluminum (BAA), Stainless Steel (BSS)	<b>AF3AE</b> 	<b>Trim Finish:</b> Black (BLK), Silver (SLV), White (WHT)	<b>AU2FE</b> 	<b>Cover Code:</b> F-AL, F-S, F-B, F-W
	<b>Option (Data &amp; Telecom):</b> A, B, C, D, E, F, G, H, J, K		<b>Body Finish:</b> White (WHT), Gray (GRY), Black (BLK), Orange (ORN), Red (RED), Green (GRN), Blue (BLU)		<b>Option (Data &amp; Telecom):</b> C, K

PRODUCT MAP  
CONFERENCE TABLES  
MEDIA TABLES  
PARSONS TABLES  
MEETING & CASUAL TABLES  
NEST TRAINING TABLES  
www.brc.group

# BRC Nova Table - 2 Tri-Base

TNTCT

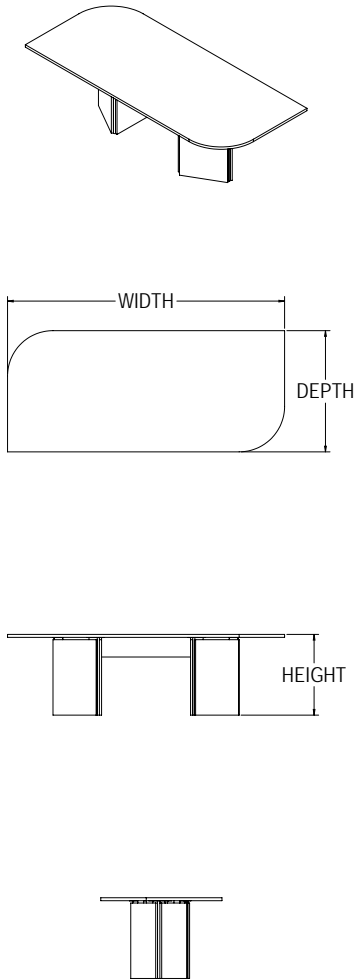

NOMINAL SIZE		TOP	POWER	LAMINATE		
WIDTH	DEPTH	SECTIONS	QUANTITY	PRICE M1	PRICE H1	PRICE K1
96"	42"	1	1	\$3,689	\$4,028	\$4,653
108"	42"	2	2	\$3,692	\$4,030	\$4,657
120"	42"	2	2	\$4,497	\$5,172	\$6,401
132"	42"	2	2	\$4,499	\$5,176	\$6,405
144"	42"	2	2	\$4,503	\$5,179	\$6,413
108"	48"	2	2	\$3,693	\$4,032	\$4,660
120"	48"	2	2	\$4,498	\$5,174	\$6,403
132"	48"	2	2	\$4,502	\$5,178	\$6,410
144"	48"	2	2	\$4,504	\$5,181	\$6,415
108"	54"	2	2	\$3,841	\$4,177	\$4,808
120"	54"	2	2	\$4,644	\$5,320	\$6,551
132"	54"	2	2	\$4,647	\$5,324	\$6,556
144"	54"	2	2	\$4,651	\$5,326	\$6,561
120"	60"	2	2	\$4,644	\$5,320	\$6,551
132"	60"	2	2	\$4,647	\$5,324	\$6,556
144"	60"	2	2	\$4,651	\$5,326	\$6,561

**ORDER CODE SAMPLE**

LINE 1	TABLE	ITEM CODE	WIDTH	DEPTH	LAMINATE
		TNTCT	W108	D48	M1
LINE 1.1	POWER & DATA	POWER OPTION	FINISH / TRIM FINISH / COVER CODE	BODY FINISH / OPTION	POWER QTY
		AF2RE	SLV	D	2

**Features & Specifications**

- Laminate codes - M1: 1" LPL, H1: 1" HPL, K1: 1.25" knife edge (top only)
- Base laminate is 3/4" LPL
- Wire management in each leg
- Height is 29" nominal, including levellers
- 108" Wide top and larger is in two sections with seam
- Available in all standard laminates and metal finishes

**No Charge Options**

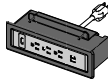
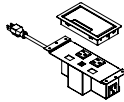
POWER & DATA	For detailed specification, cover code finishes, data and telecom options, and pricing of each electrical modules please refer to page "Power & Data Options".				
<b>AF2RE</b> 	<b>Finish:</b> Black (BLK), Silver (SLV), White (WHT), Anodized Aluminum (BAA), Stainless Steel (BSS)	<b>AF3AE</b> 	<b>Trim Finish:</b> Black (BLK), Silver (SLV), White (WHT)	<b>AU2FE</b> 	<b>Cover Code:</b> F-AL, F-S, F-B, F-W
	<b>Option (Data &amp; Telecom):</b> A, B, C, D, E, F, G, H, J, K		<b>Body Finish:</b> White (WHT), Gray (GRY), Black (BLK), Orange (ORN), Red (RED), Green (GRN), Blue (BLU)		<b>Option (Data &amp; Telecom):</b> C, K

PRODUCT MAP  
CONFERENCE TABLES  
MEDIA TABLES  
PARSONS TABLES  
MEETING & CASUAL TABLES  
NEST TRAINING TABLES  
www.brc.group

# BRC Nova Table - 3 Tri-Base

TNTCT

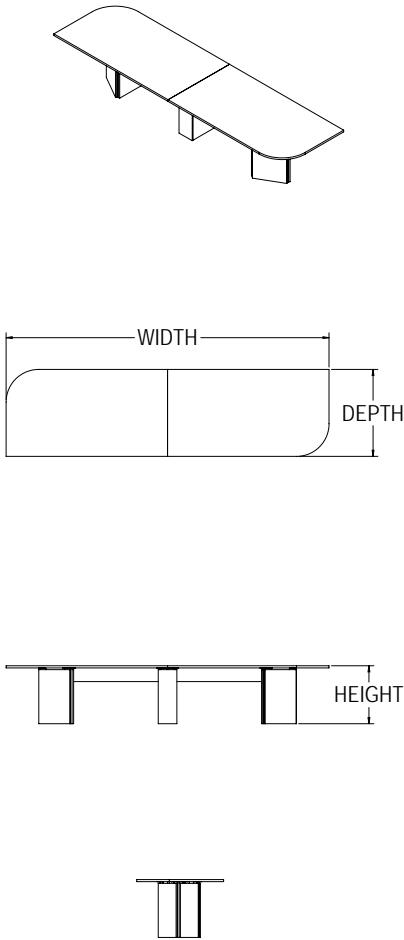

NOMINAL SIZE		TOP	POWER	LAMINATE		
WIDTH	DEPTH	SECTIONS	QUANTITY	PRICE M1	PRICE H1	PRICE K1
156"	42"	2	2	\$5,856	\$6,532	\$7,766
168"	42"	2	2	\$5,859	\$6,534	\$7,772
180"	42"	2	2	\$5,862	\$6,540	\$7,778
192"	42"	2	2	\$5,866	\$6,542	\$7,784
204"	42"	3	1, 2, 3	\$5,875	\$6,548	\$7,795
216"	42"	3	1, 2, 3	\$5,875	\$6,548	\$7,795
228"	42"	3	1, 2, 3	\$6,682	\$7,694	\$9,542
240"	42"	3	1, 2, 3	\$6,682	\$7,694	\$9,542
156"	48"	2	2	\$5,858	\$6,533	\$7,769
168"	48"	2	2	\$5,860	\$6,537	\$7,776
180"	48"	2	2	\$5,865	\$6,541	\$7,782
192"	48"	2	2	\$5,867	\$6,545	\$7,786
204"	48"	3	1, 2, 3	\$5,876	\$6,551	\$7,797
216"	48"	3	1, 2, 3	\$5,876	\$6,551	\$7,797
228"	48"	3	1, 2, 3	\$6,683	\$7,696	\$9,546
240"	48"	3	1, 2, 3	\$6,683	\$7,696	\$9,546
156"	54"	2	2	\$6,073	\$6,750	\$7,988
168"	54"	2	2	\$6,078	\$6,753	\$7,995
180"	54"	2	2	\$6,081	\$6,758	\$8,000
192"	54"	2	2	\$6,084	\$6,760	\$8,005
204"	54"	3	1, 2, 3	\$6,092	\$6,767	\$8,015
216"	54"	3	1, 2, 3	\$6,092	\$6,767	\$8,015
228"	54"	3	1, 2, 3	\$6,899	\$7,913	\$9,766
240"	54"	3	1, 2, 3	\$6,899	\$7,913	\$9,766
156"	60"	2	2	\$6,073	\$6,750	\$7,988
168"	60"	2	2	\$6,078	\$6,753	\$7,995
180"	60"	2	2	\$6,081	\$6,758	\$8,000
192"	60"	2	2	\$6,084	\$6,760	\$8,005
204"	60"	3	1, 2, 3	\$6,092	\$6,767	\$8,015
216"	60"	3	1, 2, 3	\$6,092	\$6,767	\$8,015
228"	60"	3	1, 2, 3	\$6,899	\$7,913	\$9,766
240"	60"	3	1, 2, 3	\$6,899	\$7,913	\$9,766

**ORDER CODE SAMPLE**

LINE 1	TABLE	ITEM CODE	WIDTH	DEPTH	LAMINATE
		TNTCT	W204	D48	M1
LINE 1.1	POWER & DATA	POWER OPTION	FINISH / TRIM FINISH / COVER CODE	BODY FINISH / OPTION	POWER QTY
		AF2RE	SLV	D	1

**Features & Specifications**

**No Charge Options**

- Laminate codes - M1: 1" LPL, H1: 1" HPL, K1: 1.25" knife edge (top only)
- Base laminate is 3/4" LPL
- Wire management in each leg
- Height is 29" nominal, including levellers
- Available in all standard laminates and metal finishes

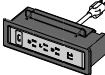
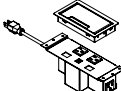
POWER & DATA					
For detailed specification, cover code finishes, data and telecom options, and pricing of each electrical modules please refer to page "Power & Data Options".					
<b>AF2RE</b> 	<b>Finish:</b> Black (BLK), Silver (SLV), White (WHT), Anodized Aluminum (BAA), Stainless Steel (BSS)	<b>AF3AE</b> 	<b>Trim Finish:</b> Black (BLK), Silver (SLV), White (WHT)	<b>AU2FE</b> 	<b>Cover Code:</b> F-AL, F-S, F-B, F-W
	<b>Option (Data &amp; Telecom):</b> A, B, C, D, E, F, G, H, J, K		<b>Body Finish:</b> White (WHT), Gray (GRY), Black (BLK), Orange (ORN), Red (RED), Green (GRN), Blue (BLU)		<b>Option (Data &amp; Telecom):</b> C, K

PRODUCT MAP  
CONFERENCE TABLES  
MEDIA TABLES  
PARSONS TABLES  
MEETING & CASUAL TABLES  
NEST TRAINING TABLES  
www.brc.group

# BRC Nova Table - 4 Tri-Base

TNTCT

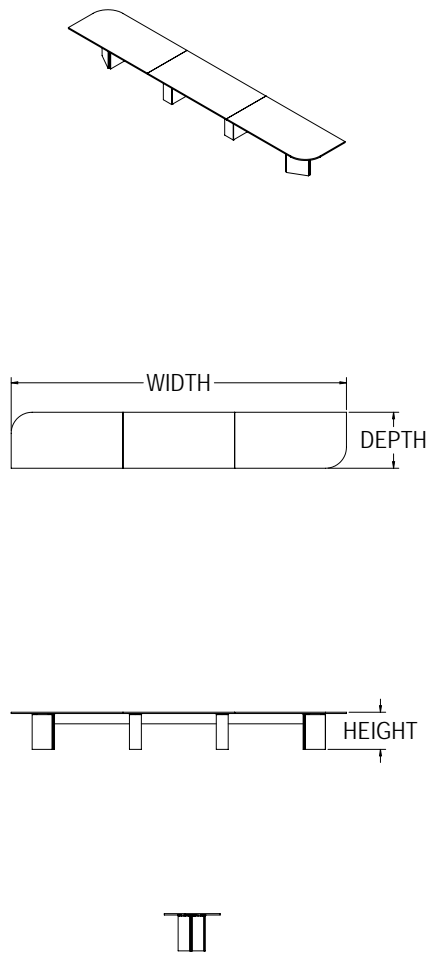

NOMINAL SIZE		TOP	POWER	LAMINATE		
WIDTH	DEPTH	SECTIONS	QUANTITY	PRICE M1	PRICE H1	PRICE K1
252"	42"	3	1, 2, 3	\$8,045	\$9,056	\$10,916
264"	42"	3	1, 2, 3	\$8,045	\$9,056	\$10,916
276"	42"	3	1, 2, 3	\$8,045	\$9,056	\$10,916
288"	42"	3	1, 2, 3	\$8,045	\$9,056	\$10,916
252"	48"	3	1, 2, 3	\$8,046	\$9,057	\$10,918
264"	48"	3	1, 2, 3	\$8,046	\$9,057	\$10,918
276"	48"	3	1, 2, 3	\$8,046	\$9,057	\$10,918
288"	48"	3	1, 2, 3	\$8,046	\$9,057	\$10,918
252"	54"	3	1, 2, 3	\$8,332	\$9,347	\$11,208
264"	54"	3	1, 2, 3	\$8,332	\$9,347	\$11,208
276"	54"	3	1, 2, 3	\$8,332	\$9,347	\$11,208
288"	54"	3	1, 2, 3	\$8,332	\$9,347	\$11,208
252"	60"	3	1, 2, 3	\$8,332	\$9,347	\$11,208
264"	60"	3	1, 2, 3	\$8,332	\$9,347	\$11,208
276"	60"	3	1, 2, 3	\$8,332	\$9,347	\$11,208
288"	60"	3	1, 2, 3	\$8,332	\$9,347	\$11,208

**ORDER CODE SAMPLE**

LINE 1	TABLE	ITEM CODE	WIDTH	DEPTH	LAMINATE
		TNTCT	W276	D48	M1
LINE 1.1	POWER & DATA	POWER OPTION	FINISH / TRIM FINISH / COVER CODE	BODY FINISH / OPTION	POWER QTY
		AF2RE	SLV	D	1

**Features & Specifications**

**No Charge Options**

- Laminate codes - M1: 1" LPL, H1: 1" HPL, K1: 1.25" knife edge (top only)
- Base laminate is 3/4" LPL
- Wire management in each leg
- Height is 29" nominal, including levelers
- Available in all standard laminates and metal finishes

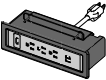
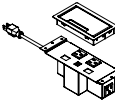
POWER & DATA					
For detailed specification, cover code finishes, data and telecom options, and pricing of each electrical modules please refer to page "Power & Data Options".					
<b>AF2RE</b> 	<b>Finish:</b> Black (BLK), Silver (SLV), White (WHT), Anodized Aluminum (BAA), Stainless Steel (BSS)	<b>AF3AE</b> 	<b>Trim Finish:</b> Black (BLK), Silver (SLV), White (WHT)	<b>AU2FE</b> 	<b>Cover Code:</b> F-AL, F-S, F-B, F-W
	<b>Option (Data &amp; Telecom):</b> A, B, C, D, E, F, G, H, J, K		<b>Body Finish:</b> White (WHT), Gray (GRY), Black (BLK), Orange (ORN), Red (RED), Green (GRN), Blue (BLU)		<b>Option (Data &amp; Telecom):</b> C, K

PRODUCT MAP  
CONFERENCE TABLES  
MEDIA TABLES  
PARSONS TABLES  
MEETING & CASUAL TABLES  
NEST TRAINING TABLES  
www.brc.group

# Trapezoid Nova Table - 2 Tri-Base

TNTZT

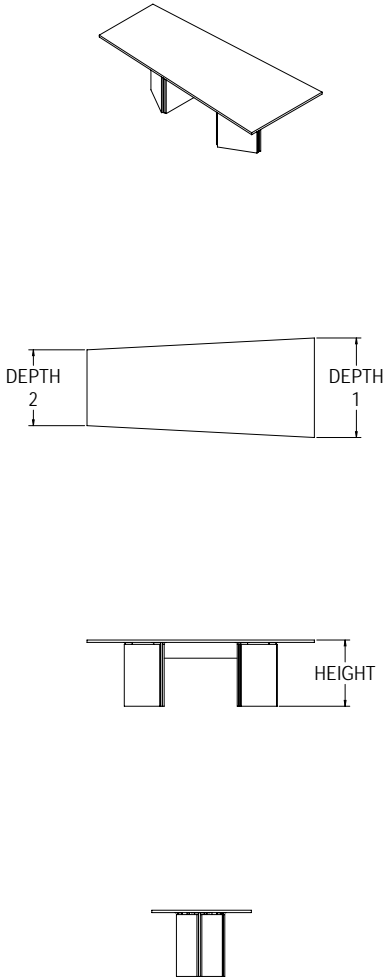

NOMINAL SIZE			TOP	POWER	LAMINATE		
WIDTH	DEPTH 1	DEPTH 2	SECTIONS	QUANTITY	PRICE M1	PRICE H1	PRICE K1
96"	42"	32"	1	1	\$3,689	\$4,472	\$5,165
108"	42"	32"	2	2	\$4,099	\$4,474	\$5,170
120"	42"	32"	2	2	\$4,992	\$5,741	\$7,106
132"	42"	32"	2	2	\$4,994	\$5,746	\$7,110
144"	42"	32"	2	2	\$4,999	\$5,749	\$7,119
108"	48"	38"	2	2	\$4,100	\$4,476	\$5,173
120"	48"	38"	2	2	\$4,993	\$5,744	\$7,108
132"	48"	38"	2	2	\$4,998	\$5,748	\$7,116
144"	48"	38"	2	2	\$5,000	\$5,751	\$7,121
108"	54"	44"	2	2	\$4,264	\$4,637	\$5,337
120"	54"	44"	2	2	\$5,155	\$5,906	\$7,272
132"	54"	44"	2	2	\$5,159	\$5,910	\$7,278
144"	54"	44"	2	2	\$5,163	\$5,912	\$7,283
120"	60"	50"	2	2	\$5,155	\$5,906	\$7,272
132"	60"	50"	2	2	\$5,159	\$5,910	\$7,278
144"	60"	50"	2	2	\$5,163	\$5,912	\$7,283

**ORDER CODE SAMPLE**

LINE 1	TABLE	ITEM CODE	WIDTH	DEPTH 1	DEPTH 2	LAMINATE	OPTION
		TNTZT	W108	D48	D38	M1	CC
LINE 1.1	POWER & DATA	POWER OPTION	FINISH / TRIM FINISH / COVER CODE	BODY FINISH / OPTION	POWER QTY		
		AF2RE	SLV	D	2		

**Features & Specifications**

No Charge Options  
Optional Extra

- Laminate codes - M1: 1" LPL, H1: 1" HPL, K1: 1.25" knife edge (top only)
- Base laminate is 3/4" LPL
- Wire management in each leg
- Height is 29" nominal, including levellers
- 108" Wide top and larger is in two sections with seam
- Available in all standard laminates and metal finishes
- For 3" curved corners add option code "CC" and \$349

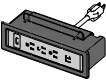
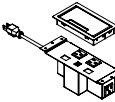
POWER & DATA	For detailed specification, cover code finishes, data and telecom options, and pricing of each electrical modules please refer to page "Power & Data Options".				
<b>AF2RE</b> 	<b>Finish:</b> Black (BLK), Silver (SLV), White (WHT), Anodized Aluminum (BAA), Stainless Steel (BSS)	<b>AF3AE</b> 	<b>Trim Finish:</b> Black (BLK), Silver (SLV), White (WHT)	<b>AU2FE</b> 	<b>Cover Code:</b> F-AL, F-S, F-B, F-W
	<b>Option (Data &amp; Telecom):</b> A, B, C, D, E, F, G, H, J, K		<b>Body Finish:</b> White (WHT), Gray (GRY), Black (BLK), Orange (ORN), Red (RED), Green (GRN), Blue (BLU)		<b>Option (Data &amp; Telecom):</b> C, K

PRODUCT MAP  
CONFERENCE TABLES  
MEDIA TABLES  
PARSONS TABLES  
MEETING & CASUAL TABLES  
NEST TRAINING TABLES  
www.brc.group

# Trapezoid Nova Table - 3 Tri-Base

TNTZT

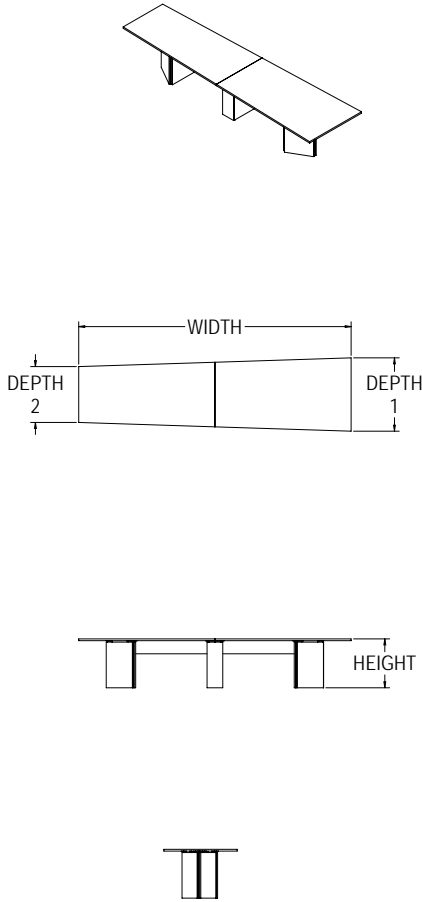

NOMINAL SIZE			TOP	POWER	LAMINATE		
WIDTH	DEPTH 1	DEPTH 2	SECTIONS	QUANTITY	PRICE M1	PRICE H1	PRICE K1
156"	42"	32"	2	2	\$5,856	\$6,532	\$7,766
168"	42"	32"	2	2	\$5,859	\$6,534	\$7,772
180"	42"	32"	2	2	\$5,862	\$6,540	\$7,778
192"	42"	32"	2	2	\$5,866	\$6,542	\$7,784
204"	42"	32"	3	1, 2, 3	\$5,875	\$6,548	\$7,795
216"	42"	32"	3	1, 2, 3	\$5,875	\$6,548	\$7,795
228"	42"	32"	3	1, 2, 3	\$6,682	\$7,694	\$9,542
240"	42"	32"	3	1, 2, 3	\$6,682	\$7,694	\$9,542
156"	48"	38"	2	2	\$5,858	\$6,533	\$7,769
168"	48"	38"	2	2	\$5,860	\$6,537	\$7,776
180"	48"	38"	2	2	\$5,865	\$6,541	\$7,782
192"	48"	38"	2	2	\$5,867	\$6,545	\$7,786
204"	48"	38"	3	1, 2, 3	\$5,876	\$6,551	\$7,797
216"	48"	38"	3	1, 2, 3	\$5,876	\$6,551	\$7,797
228"	48"	38"	3	1, 2, 3	\$6,683	\$7,696	\$9,546
240"	48"	38"	3	1, 2, 3	\$6,683	\$7,696	\$9,546
156"	54"	44"	2	2	\$6,073	\$6,750	\$7,988
168"	54"	44"	2	2	\$6,078	\$6,753	\$7,995
180"	54"	44"	2	2	\$6,081	\$6,758	\$8,000
192"	54"	44"	2	2	\$6,084	\$6,760	\$8,005
204"	54"	44"	3	1, 2, 3	\$6,092	\$6,767	\$8,015
216"	54"	44"	3	1, 2, 3	\$6,092	\$6,767	\$8,015
228"	54"	44"	3	1, 2, 3	\$6,899	\$7,913	\$9,766
240"	54"	44"	3	1, 2, 3	\$6,899	\$7,913	\$9,766
156"	60"	50"	2	2	\$6,073	\$6,750	\$7,988
168"	60"	50"	2	2	\$6,078	\$6,753	\$7,995
180"	60"	50"	2	2	\$6,081	\$6,758	\$8,000
192"	60"	50"	2	2	\$6,084	\$6,760	\$8,005
204"	60"	50"	3	1, 2, 3	\$6,092	\$6,767	\$8,015
216"	60"	50"	3	1, 2, 3	\$6,092	\$6,767	\$8,015
228"	60"	50"	3	1, 2, 3	\$6,899	\$7,913	\$9,766
240"	60"	50"	3	1, 2, 3	\$6,899	\$7,913	\$9,766

**ORDER CODE SAMPLE**

LINE 1	TABLE	ITEM CODE	WIDTH	DEPTH 1	DEPTH 2	LAMINATE	OPTION
		TNTZT	W204	D48	D38	M1	CC
LINE 1.1	POWER & DATA	POWER OPTION	FINISH / TRIM FINISH / COVER CODE	BODY FINISH / OPTION		POWER QTY	
		AF2RE	SLV	D		1	

**Features & Specifications**

No Charge Options  
Optional Extra

- Laminate codes - M1: 1" LPL, H1: 1" HPL, K1: 1.25" knife edge (top only)
- Base laminate is 3/4" LPL
- Wire management in each leg
- Height is 29" nominal, including levellers
- Available in all standard laminates and metal finishes
- For 3" curved corners add option code "CC" and \$349

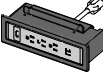
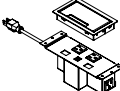
POWER & DATA	For detailed specification, cover code finishes, data and telecom options, and pricing of each electrical modules please refer to page "Power & Data Options".				
<b>AF2RE</b> 	<b>Finish:</b> Black (BLK), Silver (SLV), White (WHT), Anodized Aluminum (BAA), Stainless Steel (BSS)	<b>AF3AE</b> 	<b>Trim Finish:</b> Black (BLK), Silver (SLV), White (WHT)	<b>AU2FE</b> 	<b>Cover Code:</b> F-AL, F-S, F-B, F-W
	<b>Option (Data &amp; Telecom):</b> A, B, C, D, E, F, G, H, J, K		<b>Body Finish:</b> White (WHT), Gray (GRY), Black (BLK), Orange (ORN), Red (RED), Green (GRN), Blue (BLU)		<b>Option (Data &amp; Telecom):</b> C, K

PRODUCT MAP  
CONFERENCE TABLES  
MEDIA TABLES  
PARSONS TABLES  
MEETING & CASUAL TABLES  
NEST TRAINING TABLES  
www.brc.group

# Trapezoid Nova Table - 4 Tri-Base

TNTZT

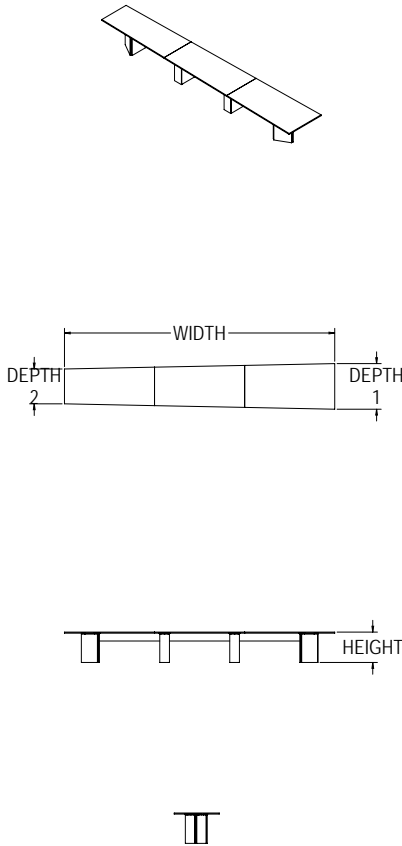

NOMINAL SIZE			TOP	POWER	LAMINATE		
WIDTH	DEPTH 1	DEPTH 2	SECTIONS	QUANTITY	PRICE M1	PRICE H1	PRICE K1
252"	42"	32"	3	1, 2, 3	\$8,045	\$9,056	\$10,916
264"	42"	32"	3	1, 2, 3	\$8,045	\$9,056	\$10,916
276"	42"	32"	3	1, 2, 3	\$8,045	\$9,056	\$10,916
288"	42"	32"	3	1, 2, 3	\$8,045	\$9,056	\$10,916
252"	48"	38"	3	1, 2, 3	\$8,046	\$9,057	\$10,918
264"	48"	38"	3	1, 2, 3	\$8,046	\$9,057	\$10,918
276"	48"	38"	3	1, 2, 3	\$8,046	\$9,057	\$10,918
288"	48"	38"	3	1, 2, 3	\$8,046	\$9,057	\$10,918
252"	54"	44"	3	1, 2, 3	\$8,332	\$9,347	\$11,208
264"	54"	44"	3	1, 2, 3	\$8,332	\$9,347	\$11,208
276"	54"	44"	3	1, 2, 3	\$8,332	\$9,347	\$11,208
288"	54"	44"	3	1, 2, 3	\$8,332	\$9,347	\$11,208
252"	60"	50"	3	1, 2, 3	\$8,332	\$9,347	\$11,208
264"	60"	50"	3	1, 2, 3	\$8,332	\$9,347	\$11,208
276"	60"	50"	3	1, 2, 3	\$8,332	\$9,347	\$11,208
288"	60"	50"	3	1, 2, 3	\$8,332	\$9,347	\$11,208

**ORDER CODE SAMPLE**

LINE 1	TABLE	ITEM CODE	WIDTH	DEPTH 1	DEPTH 2	LAMINATE	OPTION
		TNTZT	W276	D48	D38	M1	CC
LINE 1.1	POWER & DATA	POWER OPTION	FINISH / TRIM FINISH / COVER CODE	BODY FINISH / OPTION	POWER QTY		
		AF2RE	SLV	D	1		

**Features & Specifications**

No Charge Options  
Optional Extra

- Laminate codes - M1: 1" LPL, H1: 1" HPL, K1: 1.25" knife edge (top only)
- Base laminate is 3/4" LPL
- Wire management in each leg
- Height is 29" nominal, including levelers
- Available in all standard laminates and metal finishes
- For 3" curved corners add option code "CC" and \$349

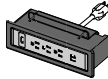
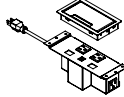
POWER & DATA	For detailed specification, cover code finishes, data and telecom options, and pricing of each electrical modules please refer to page "Power & Data Options".				
<b>AF2RE</b> 	<b>Finish:</b> Black (BLK), Silver (SLV), White (WHT), Anodized Aluminum (BAA), Stainless Steel (BSS)	<b>AF3AE</b> 	<b>Trim Finish:</b> Black (BLK), Silver (SLV), White (WHT)	<b>AU2FE</b> 	<b>Cover Code:</b> F-AL, F-S, F-B, F-W
	<b>Option (Data &amp; Telecom):</b> A, B, C, D, E, F, G, H, J, K		<b>Body Finish:</b> White (WHT), Gray (GRY), Black (BLK), Orange (ORN), Red (RED), Green (GRN), Blue (BLU)		<b>Option (Data &amp; Telecom):</b> C, K

PRODUCT MAP  
CONFERENCE TABLES  
MEDIA TABLES  
PARSONS TABLES  
MEETING & CASUAL TABLES  
NEST TRAINING TABLES  
www.brc.group

# Oval Nova Table - 2 Tri-Base

TNTOT

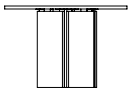
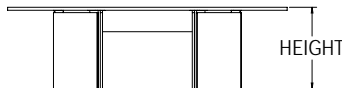
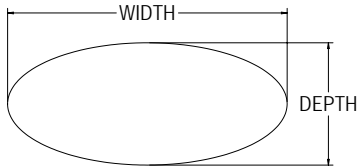
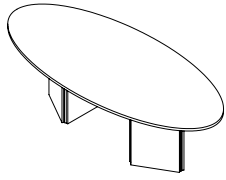

NOMINAL SIZE		TOP	POWER	LAMINATE		
WIDTH	DEPTH	SECTIONS	QUANTITY	PRICE M1	PRICE H1	PRICE K1
96"	42"	1	1	\$3,689	\$4,028	\$4,653
108"	42"	2	2	\$3,692	\$4,030	\$4,657
120"	42"	2	2	\$4,497	\$5,172	\$6,401
132"	42"	2	2	\$4,499	\$5,176	\$6,405
108"	48"	2	2	\$3,693	\$4,032	\$4,660
120"	48"	2	2	\$4,498	\$5,174	\$6,403
132"	48"	2	2	\$4,502	\$5,178	\$6,410
108"	54"	2	2	\$3,841	\$4,177	\$4,808
120"	54"	2	2	\$4,644	\$5,320	\$6,551
132"	54"	2	2	\$4,647	\$5,324	\$6,556
120"	60"	2	2	\$4,644	\$5,320	\$6,551
132"	60"	2	2	\$4,647	\$5,324	\$6,556

**ORDER CODE SAMPLE**

LINE 1	TABLE	ITEM CODE	WIDTH	DEPTH	LAMINATE
		TNTOT	W108	D48	M1
LINE 1.1	POWER & DATA	POWER OPTION	FINISH / TRIM FINISH / COVER CODE	BODY FINISH / OPTION	POWER QTY
		AF2RE	SLV	D	2

**Features & Specifications**

- Laminate codes - M1: 1" LPL, H1: 1" HPL, K1: 1.25" knife edge (top only)
- Base laminate is 3/4" LPL
- Wire management in each leg
- Height is 29" nominal, including levellers
- 108" Wide top and larger is in two sections with seam
- Available in all standard laminates and metal finishes

**No Charge Options**

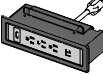
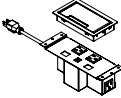
POWER & DATA	For detailed specification, cover code finishes, data and telecom options, and pricing of each electrical modules please refer to page "Power & Data Options".				
<b>AF2RE</b> 	<b>Finish:</b> Black (BLK), Silver (SLV), White (WHT), Anodized Aluminum (BAA), Stainless Steel (BSS)	<b>AF3AE</b> 	<b>Trim Finish:</b> Black (BLK), Silver (SLV), White (WHT)	<b>AU2FE</b> 	<b>Cover Code:</b> F-AL, F-S, F-B, F-W
	<b>Option (Data &amp; Telecom):</b> A, B, C, D, E, F, G, H, J, K		<b>Body Finish:</b> White (WHT), Gray (GRY), Black (BLK), Orange (ORN), Red (RED), Green (GRN), Blue (BLU)		<b>Option (Data &amp; Telecom):</b> C, K

PRODUCT MAP  
CONFERENCE TABLES  
MEDIA TABLES  
PARSONS TABLES  
MEETING & CASUAL TABLES  
NEST TRAINING TABLES  
www.brc.group

# Rectangle Disc Base Table

TDRTT

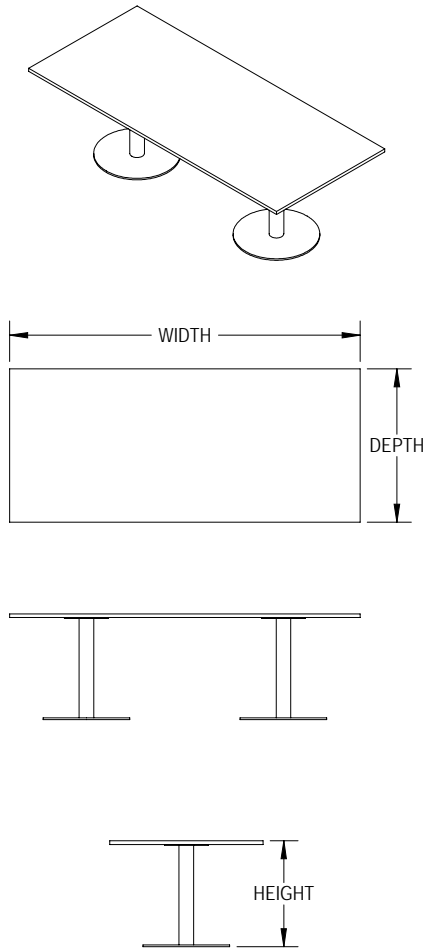

NOMINAL SIZE		POWER	LAMINATE		
WIDTH	DEPTH	QUANTITY	PRICE M1	PRICE H1	PRICE K1
60"	30"	0	\$3,316	\$3,597	\$4,220
72"	30"	0	\$3,331	\$3,614	\$4,222
60"	36"	1	\$3,342	\$3,632	\$4,149
72"	36"	1	\$3,357	\$3,651	\$4,225
72"	42"	1	\$3,768	\$4,064	\$4,638
78"	42"	1	\$3,773	\$4,073	\$4,644
84"	42"	1	\$3,773	\$4,073	\$4,644
90"	42"	1	\$3,781	\$4,083	\$4,650
96"	42"	1	\$3,781	\$4,083	\$4,650
72"	48"	1	\$3,768	\$4,064	\$4,641
78"	48"	1	\$3,773	\$4,073	\$4,647
84"	48"	1	\$3,773	\$4,073	\$4,647
90"	48"	1	\$3,781	\$4,083	\$4,651
96"	48"	1	\$3,781	\$4,083	\$4,651
72"	54"	1	\$4,397	\$4,691	\$5,275
78"	54"	1	\$4,405	\$4,702	\$5,280
84"	54"	1	\$4,405	\$4,702	\$5,280
90"	54"	1	\$4,411	\$4,711	\$5,287
96"	54"	1	\$4,411	\$4,711	\$5,287
72"	60"	1	\$5,700	\$5,996	\$6,579
78"	60"	1	\$5,706	\$6,006	\$6,583
84"	60"	1	\$5,706	\$6,006	\$6,583
90"	60"	1	\$5,714	\$6,013	\$6,588
96"	60"	1	\$5,714	\$6,013	\$6,588

**ORDER CODE SAMPLE**

LINE 1	TABLE	ITEM CODE	WIDTH	DEPTH	LAMINATE	OPTION
		TDRTT	W96	D48	M1	CC
LINE 1.1	POWER & DATA	POWER OPTION	FINISH / TRIM FINISH / COVER CODE	BODY FINISH / OPTION	POWER QTY	
		AF2RE	SLV	D	1	

**Features & Specifications**

No Charge Options

Optional Extra

- Laminate codes - M1: 1" LPL, H1: 1" HPL, K1: 1.25" knife edge (top only)
- Metal base construction
- Height is 29" nominal, including levellers
- Available in all standard laminates
- For 3" curved corners add option code "CC" and \$349
- For wire management please refer to BRC's accessories price guide

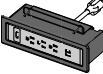
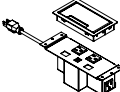
POWER & DATA	For detailed specification, cover code finishes, data and telecom options, and pricing of each electrical modules please refer to page "Power & Data Options".				
<b>AF2RE</b> 	<b>Finish:</b> Black (BLK), Silver (SLV), White (WHT), Anodized Aluminum (BAA), Stainless Steel (BSS)	<b>AF3AE</b> 	<b>Trim Finish:</b> Black (BLK), Silver (SLV), White (WHT)	<b>AU2FE</b> 	<b>Cover Code:</b> F-AL, F-S, F-B, F-W
	<b>Option (Data &amp; Telecom):</b> A, B, C, D, E, F, G, H, J, K		<b>Body Finish:</b> White (WHT), Gray (GRY), Black (BLK), Orange (ORN), Red (RED), Green (GRN), Blue (BLU)		<b>Option (Data &amp; Telecom):</b> C, K

PRODUCT MAP  
CONFERENCE TABLES  
MEDIA TABLES  
PARSONS TABLES  
MEETING & CASUAL TABLES  
NEST TRAINING TABLES  
www.brc.group

# Boat Shape Disc Base Table

TDATT

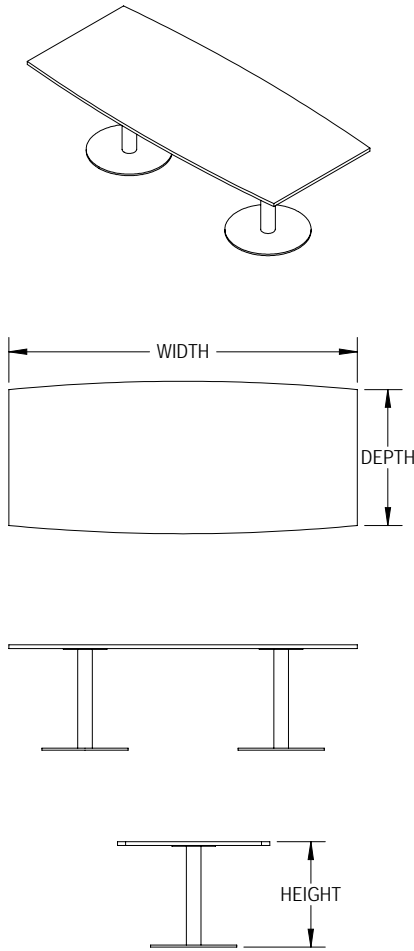

NOMINAL SIZE		POWER	LAMINATE		
WIDTH	DEPTH	QUANTITY	PRICE M1	PRICE H1	PRICE K1
60"	30"	0	\$3,427	\$3,766	\$4,382
72"	30"	0	\$3,428	\$3,767	\$4,384
60"	36"	1	\$3,416	\$3,736	\$4,304
72"	36"	1	\$3,429	\$3,768	\$4,386
72"	42"	1	\$3,844	\$4,181	\$4,803
78"	42"	1	\$3,847	\$4,184	\$4,808
84"	42"	1	\$3,847	\$4,184	\$4,808
90"	42"	1	\$3,850	\$4,190	\$4,813
96"	42"	1	\$3,850	\$4,190	\$4,813
72"	48"	1	\$3,846	\$4,182	\$4,806
78"	48"	1	\$3,848	\$4,187	\$4,810
84"	48"	1	\$3,848	\$4,187	\$4,810
90"	48"	1	\$3,851	\$4,191	\$4,816
96"	48"	1	\$3,851	\$4,191	\$4,816
72"	54"	1	\$4,477	\$4,816	\$5,437
78"	54"	1	\$4,482	\$4,819	\$5,445
84"	54"	1	\$4,482	\$4,819	\$5,445
90"	54"	1	\$4,485	\$4,821	\$5,451
96"	54"	1	\$4,485	\$4,821	\$5,451
72"	60"	1	\$5,780	\$6,120	\$6,743
78"	60"	1	\$5,785	\$6,122	\$6,748
84"	60"	1	\$5,785	\$6,122	\$6,748
90"	60"	1	\$5,787	\$6,125	\$6,753
96"	60"	1	\$5,787	\$6,125	\$6,753

**ORDER CODE SAMPLE**

LINE 1	TABLE	ITEM CODE	WIDTH	DEPTH	LAMINATE	OPTION
		TDATT	W96	D48	M1	CC
LINE 1.1	POWER & DATA	POWER OPTION	FINISH / TRIM FINISH / COVER CODE	BODY FINISH / OPTION	POWER QTY	
		AF2RE	SLV	D	1	

**Features & Specifications**

No Charge Options

Optional Extra

- Laminate codes - M1: 1" LPL, H1: 1" HPL, K1: 1.25" knife edge (top only)
- Metal base construction
- Height is 29" nominal, including levellers
- Available in all standard laminates
- For 3" curved corners add option code "CC" and \$349
- For wire management please refer to BRC's accessories price guide

**POWER & DATA** For detailed specification, cover code finishes, data and telecom options, and pricing of each electrical modules please refer to page "Power & Data Options".

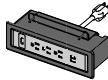
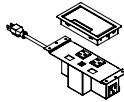
 <p><b>AF2RE</b></p>	<p><b>Finish:</b> Black (BLK), Silver (SLV), White (WHT), Anodized Aluminum (BAA), Stainless Steel (BSS)</p>	 <p><b>AF3AE</b></p>	<p><b>Trim Finish:</b> Black (BLK), Silver (SLV), White (WHT)</p>	 <p><b>AU2FE</b></p>	<p><b>Cover Code:</b> F-AL, F-S, F-B, F-W</p>
	<p><b>Option (Data &amp; Telecom):</b> A, B, C, D, E, F, G, H, J, K</p>		<p><b>Body Finish:</b> White (WHT), Gray (GRY), Black (BLK), Orange (ORN), Red (RED), Green (GRN), Blue (BLU)</p>		<p><b>Option (Data &amp; Telecom):</b> C, K</p>

# Racetrack Disc Base Table

TDETT

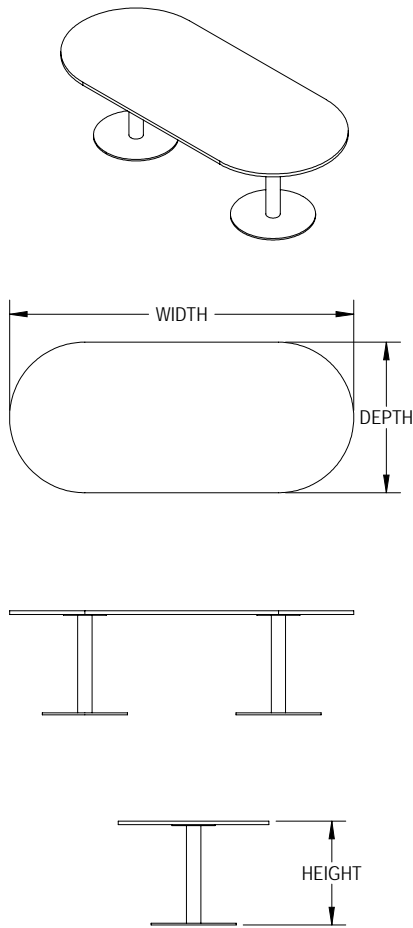

NOMINAL SIZE		POWER	LAMINATE		
WIDTH	DEPTH	QUANTITY	PRICE M1	PRICE H1	PRICE K1
60"	30"	0	\$3,427	\$3,766	\$4,382
72"	30"	0	\$3,428	\$3,767	\$4,384
60"	36"	1	\$3,416	\$3,736	\$4,304
72"	36"	1	\$3,429	\$3,768	\$4,386
72"	42"	1	\$3,844	\$4,181	\$4,803
78"	42"	1	\$3,847	\$4,184	\$4,808
84"	42"	1	\$3,847	\$4,184	\$4,808
90"	42"	1	\$3,850	\$4,190	\$4,813
96"	42"	1	\$3,850	\$4,190	\$4,813
72"	48"	1	\$3,846	\$4,182	\$4,806
78"	48"	1	\$3,848	\$4,187	\$4,810
84"	48"	1	\$3,848	\$4,187	\$4,810
90"	48"	1	\$3,851	\$4,191	\$4,816
96"	48"	1	\$3,851	\$4,191	\$4,816
72"	54"	1	\$4,477	\$4,816	\$5,437
78"	54"	1	\$4,482	\$4,819	\$5,445
84"	54"	1	\$4,482	\$4,819	\$5,445
90"	54"	1	\$4,485	\$4,821	\$5,451
96"	54"	1	\$4,485	\$4,821	\$5,451
72"	60"	1	\$5,780	\$6,120	\$6,743
78"	60"	1	\$5,785	\$6,122	\$6,748
84"	60"	1	\$5,785	\$6,122	\$6,748
90"	60"	1	\$5,787	\$6,125	\$6,753
96"	60"	1	\$5,787	\$6,125	\$6,753

**ORDER CODE SAMPLE**

LINE 1	TABLE	ITEM CODE	WIDTH	DEPTH	LAMINATE
		TDETT	W96	D48	M1
LINE 1.1	POWER & DATA	POWER OPTION	FINISH / TRIM FINISH / COVER CODE	BODY FINISH / OPTION	POWER QTY
		AF2RE	SLV	D	1

**Features & Specifications**

No Charge Options

Optional Extra

- Laminate codes - M1: 1" LPL, H1: 1" HPL, K1: 1.25" knife edge (top only)
- Metal base construction
- Height is 29" nominal, including levellers
- Available in all standard laminates
- For wire management please refer to BRC's accessories price guide

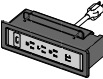
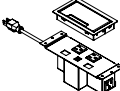
POWER & DATA	For detailed specification, cover code finishes, data and telecom options, and pricing of each electrical modules please refer to page "Power & Data Options".				
<b>AF2RE</b> 	<b>Finish:</b> Black (BLK), Silver (SLV), White (WHT), Anodized Aluminum (BAA), Stainless Steel (BSS)	<b>AF3AE</b> 	<b>Trim Finish:</b> Black (BLK), Silver (SLV), White (WHT)	<b>AU2FE</b> 	<b>Cover Code:</b> F-AL, F-S, F-B, F-W
	<b>Option (Data &amp; Telecom):</b> A, B, C, D, E, F, G, H, J, K		<b>Body Finish:</b> White (WHT), Gray (GRY), Black (BLK), Orange (ORN), Red (RED), Green (GRN), Blue (BLU)		<b>Option (Data &amp; Telecom):</b> C, K

PRODUCT MAP  
CONFERENCE TABLES  
MEDIA TABLES  
PARSONS TABLES  
MEETING & CASUAL TABLES  
NEST TRAINING TABLES  
www.brc.group

# Boat Arced Disc Base Table

TDBTT

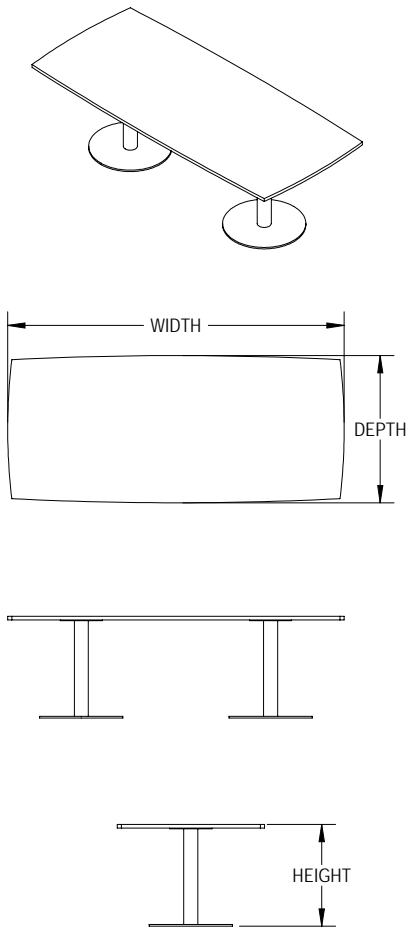

NOMINAL SIZE		POWER	LAMINATE		
WIDTH	DEPTH	QUANTITY	PRICE M1	PRICE H1	PRICE K1
60"	30"	0	\$3,427	\$3,766	\$4,382
72"	30"	0	\$3,428	\$3,767	\$4,384
60"	36"	1	\$3,416	\$3,736	\$4,304
72"	36"	1	\$3,429	\$3,768	\$4,386
72"	42"	1	\$3,844	\$4,181	\$4,803
78"	42"	1	\$3,847	\$4,184	\$4,808
84"	42"	1	\$3,847	\$4,184	\$4,808
90"	42"	1	\$3,850	\$4,190	\$4,813
96"	42"	1	\$3,850	\$4,190	\$4,813
72"	48"	1	\$3,846	\$4,182	\$4,806
78"	48"	1	\$3,848	\$4,187	\$4,810
84"	48"	1	\$3,848	\$4,187	\$4,810
90"	48"	1	\$3,851	\$4,191	\$4,816
96"	48"	1	\$3,851	\$4,191	\$4,816
72"	54"	1	\$4,477	\$4,816	\$5,437
78"	54"	1	\$4,482	\$4,819	\$5,445
84"	54"	1	\$4,482	\$4,819	\$5,445
90"	54"	1	\$4,485	\$4,821	\$5,451
96"	54"	1	\$4,485	\$4,821	\$5,451
72"	60"	1	\$5,780	\$6,120	\$6,743
78"	60"	1	\$5,785	\$6,122	\$6,748
84"	60"	1	\$5,785	\$6,122	\$6,748
90"	60"	1	\$5,787	\$6,125	\$6,753
96"	60"	1	\$5,787	\$6,125	\$6,753

**ORDER CODE SAMPLE**

LINE 1	TABLE	ITEM CODE	WIDTH	DEPTH	LAMINATE	OPTION
		TDBTT	W96	D48	M1	CC
LINE 1.1	POWER & DATA	POWER OPTION	FINISH / TRIM FINISH / COVER CODE	BODY FINISH / OPTION	POWER QTY	
		AF2RE	SLV	D	1	

**Features & Specifications**

No Charge Options

Optional Extra

- Laminate codes - M1: 1" LPL, H1: 1" HPL, K1: 1.25" knife edge (top only)
- Metal base construction
- Height is 29" nominal, including levellers
- Available in all standard laminates
- For 3" curved corners add option code "CC" and \$349
- For wire management please refer to BRC's accessories price guide

**POWER & DATA** For detailed specification, cover code finishes, data and telecom options, and pricing of each electrical modules please refer to page "Power & Data Options".

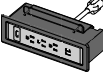
 <p><b>AF2RE</b></p>	<p><b>Finish:</b> Black (BLK), Silver (SLV), White (WHT), Anodized Aluminum (BAA), Stainless Steel (BSS)</p>	 <p><b>AF3AE</b></p>	<p><b>Trim Finish:</b> Black (BLK), Silver (SLV), White (WHT)</p>	 <p><b>AU2FE</b></p>	<p><b>Cover Code:</b> F-AL, F-S, F-B, F-W</p>
	<p><b>Option (Data &amp; Telecom):</b> A, B, C, D, E, F, G, H, J, K</p>		<p><b>Body Finish:</b> White (WHT), Gray (GRY), Black (BLK), Orange (ORN), Red (RED), Green (GRN), Blue (BLU)</p>		<p><b>Option (Data &amp; Telecom):</b> C, K</p>

# BRC Disc Base Table

TDCTT

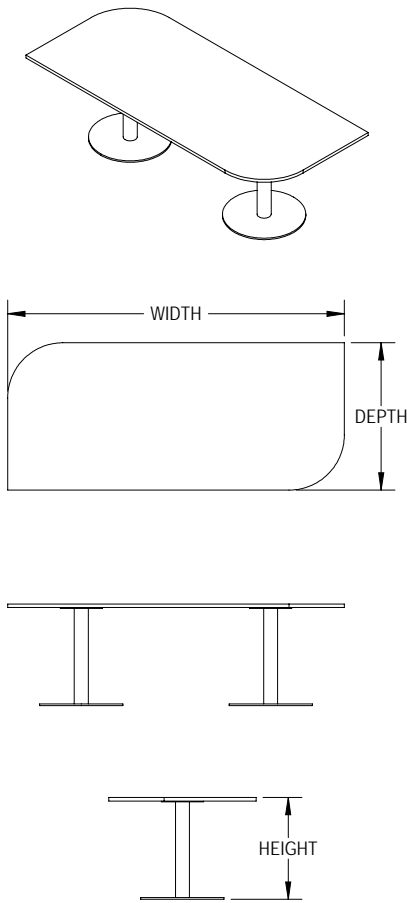

NOMINAL SIZE		POWER	LAMINATE		
WIDTH	DEPTH	QUANTITY	PRICE M1	PRICE H1	PRICE K1
60"	30"	0	\$3,427	\$3,766	\$4,382
72"	30"	0	\$3,428	\$3,767	\$4,384
60"	36"	1	\$3,416	\$3,736	\$4,304
72"	36"	1	\$3,429	\$3,768	\$4,386
72"	42"	1	\$3,844	\$4,181	\$4,803
78"	42"	1	\$3,847	\$4,184	\$4,808
84"	42"	1	\$3,847	\$4,184	\$4,808
90"	42"	1	\$3,850	\$4,190	\$4,813
96"	42"	1	\$3,850	\$4,190	\$4,813
72"	48"	1	\$3,846	\$4,182	\$4,806
78"	48"	1	\$3,848	\$4,187	\$4,810
84"	48"	1	\$3,848	\$4,187	\$4,810
90"	48"	1	\$3,851	\$4,191	\$4,816
96"	48"	1	\$3,851	\$4,191	\$4,816
72"	54"	1	\$4,477	\$4,816	\$5,437
78"	54"	1	\$4,482	\$4,819	\$5,445
84"	54"	1	\$4,482	\$4,819	\$5,445
90"	54"	1	\$4,485	\$4,821	\$5,451
96"	54"	1	\$4,485	\$4,821	\$5,451
72"	60"	1	\$5,780	\$6,120	\$6,743
78"	60"	1	\$5,785	\$6,122	\$6,748
84"	60"	1	\$5,785	\$6,122	\$6,748
90"	60"	1	\$5,787	\$6,125	\$6,753
96"	60"	1	\$5,787	\$6,125	\$6,753

**ORDER CODE SAMPLE**

LINE 1	TABLE	ITEM CODE	WIDTH	DEPTH	LAMINATE
		TDCTT	W96	D48	M1
LINE 1.1	POWER & DATA	POWER OPTION	FINISH / TRIM FINISH / COVER CODE	BODY FINISH / OPTION	POWER QTY
		AF2RE	SLV	D	1

**Features & Specifications**

No Charge Options

Optional Extra

- Laminate codes - M1: 1" LPL, H1: 1" HPL, K1: 1.25" knife edge (top only)
- Metal base construction
- Height is 29" nominal, including levellers
- Available in all standard laminates
- For wire management please refer to BRC's accessories price guide

**POWER & DATA** For detailed specification, cover code finishes, data and telecom options, and pricing of each electrical modules please refer to page "Power & Data Options".

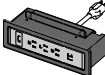
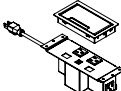
 <p><b>AF2RE</b></p>	<p><b>Finish:</b> Black (BLK), Silver (SLV), White (WHT), Anodized Aluminum (BAA), Stainless Steel (BSS)</p>	 <p><b>AF3AE</b></p>	<p><b>Trim Finish:</b> Black (BLK), Silver (SLV), White (WHT)</p>	 <p><b>AU2FE</b></p>	<p><b>Cover Code:</b> F-AL, F-S, F-B, F-W</p>
	<p><b>Option (Data &amp; Telecom):</b> A, B, C, D, E, F, G, H, J, K</p>		<p><b>Body Finish:</b> White (WHT), Gray (GRY), Black (BLK), Orange (ORN), Red (RED), Green (GRN), Blue (BLU)</p>		<p><b>Option (Data &amp; Telecom):</b> C, K</p>

# Trapezoid Disc Base Table

TDTTT

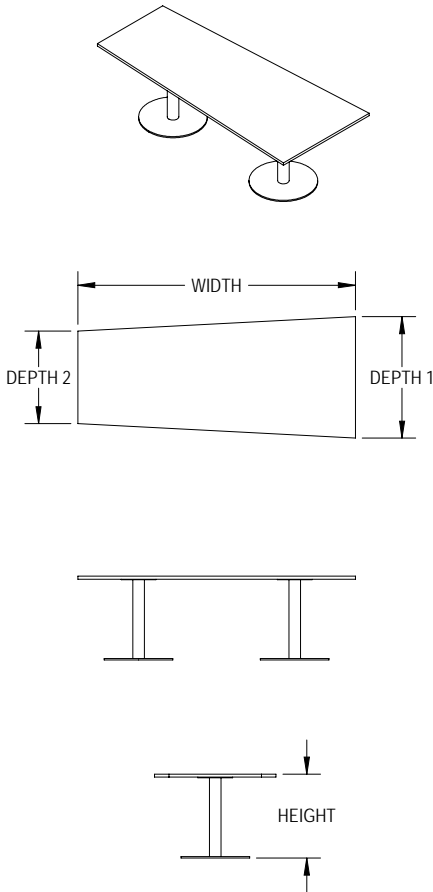

NOMINAL SIZE			POWER	LAMINATE		
WIDTH	DEPTH 1	DEPTH 2		QUANTITY	PRICE M1	PRICE H1
72"	42"	32"	0	\$3,844	\$4,181	\$4,803
78"	42"	32"	0	\$3,847	\$4,184	\$4,808
84"	42"	32"	1	\$3,847	\$4,184	\$4,808
90"	42"	32"	1	\$3,850	\$4,190	\$4,813
96"	42"	32"	1	\$3,850	\$4,190	\$4,813
72"	48"	38"	1	\$3,846	\$4,182	\$4,806
78"	48"	38"	1	\$3,848	\$4,187	\$4,810
84"	48"	38"	1	\$3,848	\$4,187	\$4,810
90"	48"	38"	1	\$3,851	\$4,191	\$4,816
96"	48"	38"	1	\$3,851	\$4,191	\$4,816
72"	54"	44"	1	\$4,477	\$4,816	\$5,437
78"	54"	44"	1	\$4,482	\$4,819	\$5,445
84"	54"	44"	1	\$4,482	\$4,819	\$5,445
90"	54"	44"	1	\$4,485	\$4,821	\$5,451
96"	54"	44"	1	\$4,485	\$4,821	\$5,451
72"	60"	50"	1	\$5,780	\$6,120	\$6,743
78"	60"	50"	1	\$5,785	\$6,122	\$6,748
84"	60"	50"	1	\$5,785	\$6,122	\$6,748
90"	60"	50"	1	\$5,787	\$6,125	\$6,753
96"	60"	50"	1	\$5,787	\$6,125	\$6,753

**ORDER CODE SAMPLE**

LINE 1	TABLE	ITEM CODE	WIDTH	DEPTH 1	DEPTH 2	LAMINATE	OPTION
		TDTTT	W96	D48	D38	M1	CC
LINE 1.1	POWER & DATA	POWER OPTION	FINISH / TRIM FINISH / COVER CODE	BODY FINISH / OPTION	POWER QTY		
		AF2RE	SLV	D	1		

**Features & Specifications**

No Charge Options

Optional Extra

- Laminate codes - M1: 1" LPL, H1: 1" HPL, K1: 1.25" knife edge (top only)
- Metal base construction
- Height is 29" nominal, including levellers
- Available in all standard laminates
- For 3" curved corners add option code "CC" and \$349
- For wire management please refer to BRC's accessories price guide

**POWER & DATA** For detailed specification, cover code finishes, data and telecom options, and pricing of each electrical modules please refer to page "Power & Data Options".

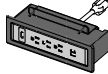
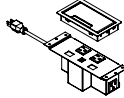
 <p><b>AF2RE</b></p>	<p><b>Finish:</b> Black (BLK), Silver (SLV), White (WHT), Anodized Aluminum (BAA), Stainless Steel (BSS)</p>	 <p><b>AF3AE</b></p>	<p><b>Trim Finish:</b> Black (BLK), Silver (SLV), White (WHT)</p>	 <p><b>AU2FE</b></p>	<p><b>Cover Code:</b> F-AL, F-S, F-B, F-W</p>
	<p><b>Option (Data &amp; Telecom):</b> A, B, C, D, E, F, G, H, J, K</p>		<p><b>Body Finish:</b> White (WHT), Gray (GRY), Black (BLK), Orange (ORN), Red (RED), Green (GRN), Blue (BLU)</p>		<p><b>Option (Data &amp; Telecom):</b> C, K</p>

PRODUCT MAP  
CONFERENCE TABLES  
MEDIA TABLES  
PARSONS TABLES  
MEETING & CASUAL TABLES  
NEST TRAINING TABLES  
www.brc.group

# Oval Disc Base Table

TDOTT

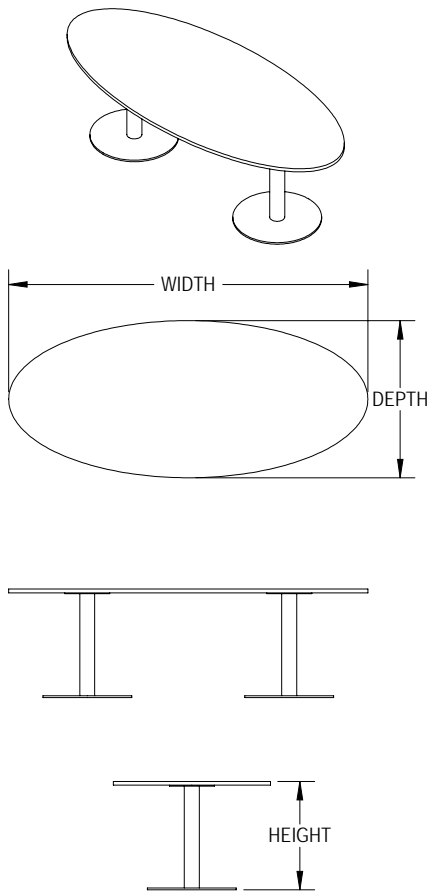

NOMINAL SIZE		POWER	LAMINATE		
WIDTH	DEPTH	QUANTITY	PRICE M1	PRICE H1	PRICE K1
60"	30"	0	\$3,427	\$3,766	\$4,382
72"	30"	0	\$3,428	\$3,767	\$4,384
60"	36"	1	\$3,416	\$3,736	\$4,304
72"	36"	1	\$3,429	\$3,768	\$4,386
72"	42"	1	\$3,844	\$4,181	\$4,803
78"	42"	1	\$3,847	\$4,184	\$4,808
84"	42"	1	\$3,847	\$4,184	\$4,808
90"	42"	1	\$3,850	\$4,190	\$4,813
96"	42"	1	\$3,850	\$4,190	\$4,813
72"	48"	1	\$3,846	\$4,182	\$4,806
78"	48"	1	\$3,848	\$4,187	\$4,810
84"	48"	1	\$3,848	\$4,187	\$4,810
90"	48"	1	\$3,851	\$4,191	\$4,816
96"	48"	1	\$3,851	\$4,191	\$4,816
72"	54"	1	\$4,477	\$4,816	\$5,437
78"	54"	1	\$4,482	\$4,819	\$5,445
84"	54"	1	\$4,482	\$4,819	\$5,445
90"	54"	1	\$4,485	\$4,821	\$5,451
96"	54"	1	\$4,485	\$4,821	\$5,451
72"	60"	1	\$5,780	\$6,120	\$6,743
78"	60"	1	\$5,785	\$6,122	\$6,748
84"	60"	1	\$5,785	\$6,122	\$6,748
90"	60"	1	\$5,787	\$6,125	\$6,753
96"	60"	1	\$5,787	\$6,125	\$6,753

**ORDER CODE SAMPLE**

LINE 1	TABLE	ITEM CODE	WIDTH	DEPTH	LAMINATE
		TDOTT	W96	D48	M1
LINE 1.1	POWER & DATA	POWER OPTION	FINISH / TRIM FINISH / COVER CODE	BODY FINISH / OPTION	POWER QTY
		AF2RE	SLV	D	1

**Features & Specifications**

No Charge Options

Optional Extra

- Laminate codes - M1: 1" LPL, H1: 1" HPL, K1: 1.25" knife edge (top only)
- Metal base construction
- Height is 29" nominal, including levellers
- Available in all standard laminates
- For wire management please refer to BRC's accessories price guide

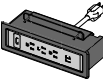
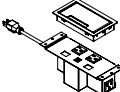
POWER & DATA	For detailed specification, cover code finishes, data and telecom options, and pricing of each electrical modules please refer to page "Power & Data Options".				
<b>AF2RE</b> 	<b>Finish:</b> Black (BLK), Silver (SLV), White (WHT), Anodized Aluminum (BAA), Stainless Steel (BSS)	<b>AF3AE</b> 	<b>Trim Finish:</b> Black (BLK), Silver (SLV), White (WHT)	<b>AU2FE</b> 	<b>Cover Code:</b> F-AL, F-S, F-B, F-W
	<b>Option (Data &amp; Telecom):</b> A, B, C, D, E, F, G, H, J, K		<b>Body Finish:</b> White (WHT), Gray (GRY), Black (BLK), Orange (ORN), Red (RED), Green (GRN), Blue (BLU)		<b>Option (Data &amp; Telecom):</b> C, K

PRODUCT MAP  
CONFERENCE TABLES  
MEDIA TABLES  
PARSONS TABLES  
MEETING & CASUAL TABLES  
NEST TRAINING TABLES  
www.brc.group

# Rectangle Panel Base Table - 2 Base

TPRTT

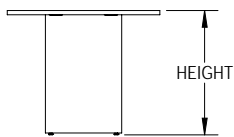
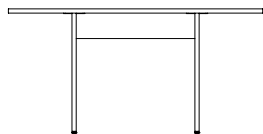
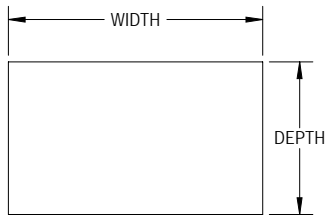
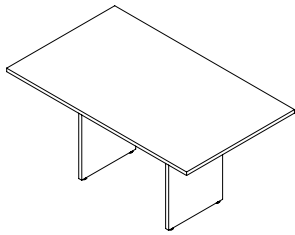

NOMINAL SIZE		POWER	LAMINATE		
WIDTH	DEPTH	QUANTITY	PRICE M1	PRICE H1	PRICE K1
60"	30"	0	\$1,541	\$1,806	\$2,400
72"	30"	0	\$1,577	\$1,849	\$2,426
60"	36"	1	\$1,566	\$1,842	\$2,334
72"	36"	1	\$1,602	\$1,883	\$2,429
72"	42"	1	\$1,602	\$1,883	\$2,431
78"	42"	1	\$1,620	\$1,904	\$2,448
84"	42"	1	\$1,854	\$2,139	\$2,683
90"	42"	1	\$1,874	\$2,159	\$2,699
96"	42"	1	\$1,885	\$2,171	\$2,711
72"	48"	1	\$1,633	\$1,914	\$2,466
78"	48"	1	\$1,652	\$1,935	\$2,481
84"	48"	1	\$1,886	\$2,169	\$2,718
90"	48"	1	\$1,904	\$2,192	\$2,734
96"	48"	1	\$1,915	\$2,204	\$2,746
72"	54"	1	\$1,667	\$1,947	\$2,501
78"	54"	1	\$1,683	\$1,966	\$2,518
84"	54"	1	\$1,919	\$2,203	\$2,753
90"	54"	1	\$1,936	\$2,222	\$2,770
96"	54"	1	\$1,949	\$2,234	\$2,781
72"	60"	1	\$1,697	\$1,979	\$2,534
78"	60"	1	\$1,714	\$2,000	\$2,550
84"	60"	1	\$1,951	\$2,234	\$2,785
90"	60"	1	\$1,969	\$2,255	\$2,801
96"	60"	1	\$1,980	\$2,265	\$2,813

**ORDER CODE SAMPLE**

LINE 1	TABLE	ITEM CODE	WIDTH	DEPTH	LAMINATE	OPTION
		TPRTT	W96	D48	M1	CC
LINE 1.1	POWER & DATA	POWER OPTION	FINISH / TRIM FINISH / COVER CODE	BODY FINISH / OPTION	POWER QTY	
		AF2RE	SLV	D	1	

**Features & Specifications**

No Charge Options

Optional Extra

- Laminate codes - M1: 1" LPL, H1: 1" HPL, K1: 1.25" knife edge (top only)
- Base laminate is 1" LPL
- Height is 29" nominal, including levellers
- Available in all standard laminates
- For 3" curved corners add option code "CC" and \$349
- For wire management please refer to BRC's accessories price guide

**POWER & DATA** For detailed specification, cover code finishes, data and telecom options, and pricing of each electrical modules please refer to page "Power & Data Options".

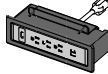
 <p><b>AF2RE</b></p>	<p><b>Finish:</b> Black (BLK), Silver (SLV), White (WHT), Anodized Aluminum (BAA), Stainless Steel (BSS)</p>	 <p><b>AF3AE</b></p>	<p><b>Trim Finish:</b> Black (BLK), Silver (SLV), White (WHT)</p>	 <p><b>AU2FE</b></p>	<p><b>Cover Code:</b> F-AL, F-S, F-B, F-W</p>
	<p><b>Option (Data &amp; Telecom):</b> A, B, C, D, E, F, G, H, J, K</p>		<p><b>Body Finish:</b> White (WHT), Gray (GRY), Black (BLK), Orange (ORN), Red (RED), Green (GRN), Blue (BLU)</p>		<p><b>Option (Data &amp; Telecom):</b> C, K</p>

PRODUCT MAP  
CONFERENCE TABLES  
MEDIA TABLES  
PARSONS TABLES  
MEETING & CASUAL TABLES  
NEST TRAINING TABLES  
www.brc.group

# Rectangle Panel Base Table - 3 Base

TPRTT

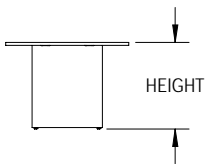
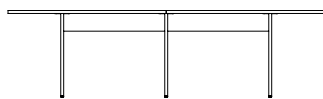
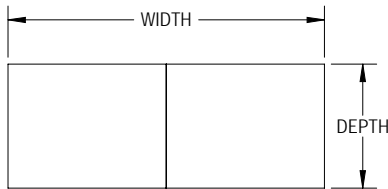
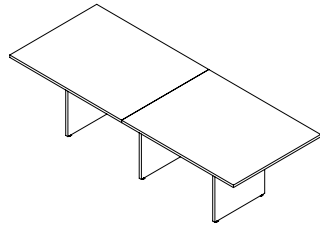

NOMINAL SIZE		POWER	LAMINATE		
WIDTH	DEPTH	QUANTITY	PRICE M1	PRICE H1	PRICE K1
108"	42"	1, 2	\$2,188	\$2,480	\$3,006
120"	42"	1, 2	\$2,847	\$3,385	\$4,539
132"	42"	1, 2	\$2,883	\$3,427	\$4,569
144"	42"	1, 2	\$2,920	\$3,467	\$4,598
108"	48"	1, 2	\$2,220	\$2,512	\$3,042
120"	48"	1, 2	\$2,878	\$3,416	\$4,575
132"	48"	1, 2	\$2,914	\$3,458	\$4,603
144"	48"	1, 2	\$2,951	\$3,500	\$4,630
108"	54"	1, 2	\$2,254	\$2,544	\$3,077
120"	54"	1, 2	\$2,910	\$3,449	\$4,611
132"	54"	1, 2	\$2,946	\$3,489	\$4,639
144"	54"	1, 2	\$2,981	\$3,530	\$4,667
108"	60"	1, 2	\$2,284	\$2,575	\$3,109
120"	60"	1, 2	\$2,942	\$3,480	\$4,641
132"	60"	1, 2	\$2,978	\$3,521	\$4,669
144"	60"	1, 2	\$3,013	\$3,562	\$4,698

**ORDER CODE SAMPLE**

LINE 1	TABLE	ITEM CODE	WIDTH	DEPTH	LAMINATE	OPTION
		TPRTT	W108	D48	M1	CC
LINE 1.1	POWER & DATA	POWER OPTION	FINISH / TRIM FINISH / COVER CODE	BODY FINISH / OPTION	POWER QTY	
		AF2RE	SLV	D	1	

**Features & Specifications**

No Charge Options

Optional Extra

- Laminate codes - M1: 1" LPL, H1: 1" HPL, K1: 1.25" knife edge (top only)
- Base laminate is 1" LPL
- Height is 29" nominal, including levellers
- Available in all standard laminates
- For 3" curved corners add option code "CC" and \$349
- For wire management please refer to BRC's accessories price guide

**POWER & DATA** For detailed specification, cover code finishes, data and telecom options, and pricing of each electrical modules please refer to page "Power & Data Options".

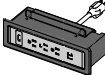
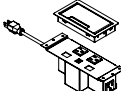
 <p><b>AF2RE</b></p>	<p><b>Finish:</b> Black (BLK), Silver (SLV), White (WHT), Anodized Aluminum (BAA), Stainless Steel (BSS)</p>	 <p><b>AF3AE</b></p>	<p><b>Trim Finish:</b> Black (BLK), Silver (SLV), White (WHT)</p>	 <p><b>AU2FE</b></p>	<p><b>Cover Code:</b> F-AL, F-S, F-B, F-W</p>
	<p><b>Option (Data &amp; Telecom):</b> A, B, C, D, E, F, G, H, J, K</p>		<p><b>Body Finish:</b> White (WHT), Gray (GRY), Black (BLK), Orange (ORN), Red (RED), Green (GRN), Blue (BLU)</p>		<p><b>Option (Data &amp; Telecom):</b> C, K</p>

PRODUCT MAP  
CONFERENCE TABLES  
MEDIA TABLES  
PARSONS TABLES  
MEETING & CASUAL TABLES  
NEST TRAINING TABLES  
www.brc.group

# Arced Boat Panel Base Table - 2 Base

TPBAT

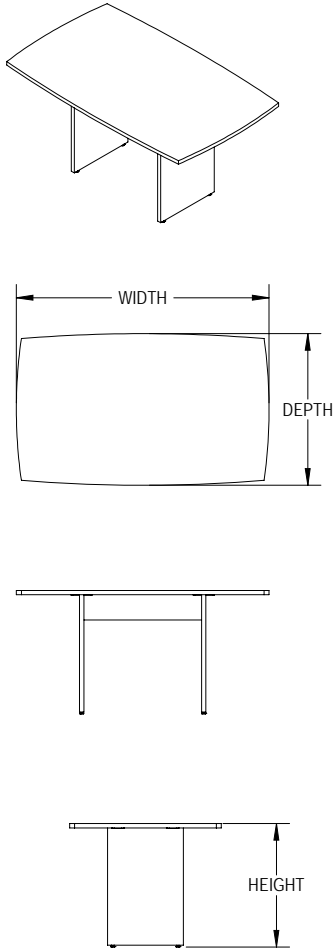

NOMINAL SIZE		POWER	LAMINATE		
WIDTH	DEPTH	QUANTITY	PRICE M1	PRICE H1	PRICE K1
60"	30"	0	\$1,646	\$1,969	\$2,556
72"	30"	0	\$1,671	\$1,992	\$2,581
60"	36"	1	\$1,637	\$1,940	\$2,481
72"	36"	1	\$1,672	\$1,994	\$2,583
72"	42"	1	\$1,674	\$1,996	\$2,587
78"	42"	1	\$1,689	\$2,011	\$2,603
84"	42"	1	\$1,924	\$2,245	\$2,839
90"	42"	1	\$1,939	\$2,260	\$2,855
96"	42"	1	\$1,951	\$2,272	\$2,868
72"	48"	1	\$1,707	\$2,030	\$2,620
78"	48"	1	\$1,722	\$2,043	\$2,639
84"	48"	1	\$1,956	\$2,279	\$2,873
90"	48"	1	\$1,973	\$2,294	\$2,890
96"	48"	1	\$1,983	\$2,306	\$2,901
72"	54"	1	\$1,743	\$2,064	\$2,658
78"	54"	1	\$1,757	\$2,080	\$2,673
84"	54"	1	\$1,992	\$2,314	\$2,910
90"	54"	1	\$2,006	\$2,328	\$2,926
96"	54"	1	\$2,017	\$2,340	\$2,939
72"	60"	1	\$1,773	\$2,096	\$2,690
78"	60"	1	\$1,788	\$2,109	\$2,706
84"	60"	1	\$2,024	\$2,345	\$2,941
90"	60"	1	\$2,038	\$2,360	\$2,959
96"	60"	1	\$2,051	\$2,371	\$2,971

**ORDER CODE SAMPLE**

LINE 1	TABLE	ITEM CODE	WIDTH	DEPTH	LAMINATE	OPTION
		TPBAT	W96	D48	M1	CC
LINE 1.1	POWER & DATA	POWER OPTION	FINISH / TRIM FINISH / COVER CODE	BODY FINISH / OPTION	POWER QTY	
		AF2RE	SLV	D	1	

**Features & Specifications**

No Charge Options

Optional Extra

- Laminate codes - M1: 1" LPL, H1: 1" HPL, K1: 1.25" knife edge (top only)
- Base laminate is 1" LPL
- Height is 29" nominal, including levellers
- Available in all standard laminates
- For 3" curved corners add option code "CC" and \$349
- For wire management please refer to BRC's accessories price guide

**POWER & DATA** For detailed specification, cover code finishes, data and telecom options, and pricing of each electrical modules please refer to page "Power & Data Options".

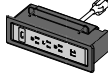
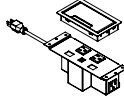
 <p><b>AF2RE</b></p>	<p><b>Finish:</b> Black (BLK), Silver (SLV), White (WHT), Anodized Aluminum (BAA), Stainless Steel (BSS)</p>	 <p><b>AF3AE</b></p>	<p><b>Trim Finish:</b> Black (BLK), Silver (SLV), White (WHT)</p>	 <p><b>AU2FE</b></p>	<p><b>Cover Code:</b> F-AL, F-S, F-B, F-W</p>
	<p><b>Option (Data &amp; Telecom):</b> A, B, C, D, E, F, G, H, J, K</p>		<p><b>Body Finish:</b> White (WHT), Gray (GRY), Black (BLK), Orange (ORN), Red (RED), Green (GRN), Blue (BLU)</p>		<p><b>Option (Data &amp; Telecom):</b> C, K</p>

# Arced Boat Panel Base Table - 3 Base

TPBAT

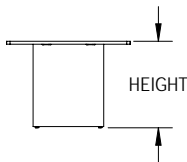
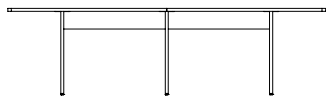
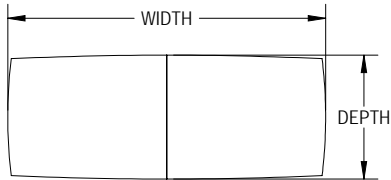
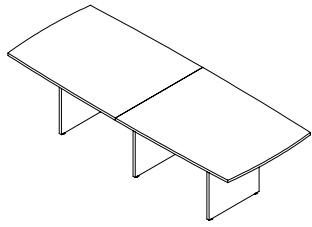

NOMINAL SIZE		POWER	LAMINATE		
WIDTH	DEPTH	QUANTITY	PRICE M1	PRICE H1	PRICE K1
108"	42"	1, 2	\$2,245	\$2,567	\$3,164
120"	42"	1, 2	\$3,034	\$3,679	\$4,847
132"	42"	1, 2	\$3,061	\$3,706	\$4,877
144"	42"	1, 2	\$3,087	\$3,731	\$4,906
108"	48"	1, 2	\$2,279	\$2,600	\$3,198
120"	48"	1, 2	\$3,067	\$3,712	\$4,882
132"	48"	1, 2	\$3,094	\$3,739	\$4,911
144"	48"	1, 2	\$3,121	\$3,765	\$4,939
108"	54"	1, 2	\$2,313	\$2,635	\$3,234
120"	54"	1, 2	\$3,103	\$3,746	\$4,919
132"	54"	1, 2	\$3,128	\$3,772	\$4,947
144"	54"	1, 2	\$3,155	\$3,799	\$4,976
108"	60"	1, 2	\$2,345	\$2,667	\$3,266
120"	60"	1, 2	\$3,133	\$3,778	\$4,950
132"	60"	1, 2	\$3,160	\$3,803	\$4,979
144"	60"	1, 2	\$3,186	\$3,830	\$5,009

**ORDER CODE SAMPLE**



LINE 1	TABLE	ITEM CODE	WIDTH	DEPTH	LAMINATE	OPTION
		TPBAT	W108	D48	M1	CC
LINE 1.1	POWER & DATA	POWER OPTION	FINISH / TRIM FINISH / COVER CODE	BODY FINISH / OPTION	POWER QTY	
		AF2RE	SLV	D	1	

**Features & Specifications**

No Charge Options

Optional Extra

- Laminate codes - M1: 1" LPL, H1: 1" HPL, K1: 1.25" knife edge (top only)
- Base laminate is 1" LPL
- Height is 29" nominal, including levellers
- Available in all standard laminates
- For 3" curved corners add option code "CC" and \$349
- For wire management please refer to BRC's accessories price guide

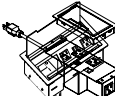
<b>POWER &amp; DATA</b>	For detailed specification, cover code finishes, data and telecom options, and pricing of each electrical modules please refer to page "Power & Data Options".				
 <b>AF2RE</b> <b>Finish:</b> Black, Silver, White, Anodized Aluminum, Stainless Steel <b>Option (Data &amp; Telecom):</b> A, B, C, D, E, F, G, H, J, K	 <b>AF3AE</b> <b>Trim Finish:</b> Black, Silver, White <b>Body Finish:</b> White, Gray, Black, Orange, Red, Green, Blue	 <b>AU2FE</b> <b>Cover Code:</b> F-AL, F-S, F-B, F-W <b>Option (Data &amp; Telecom):</b> C, K			

PRODUCT MAP  
CONFERENCE TABLES  
MEDIA TABLES  
PARSONS TABLES  
MEETING & CASUAL TABLES  
NEST TRAINING TABLES  
www.brc.group

# Racetrack Panel Base Table - 2 Base

TPBET

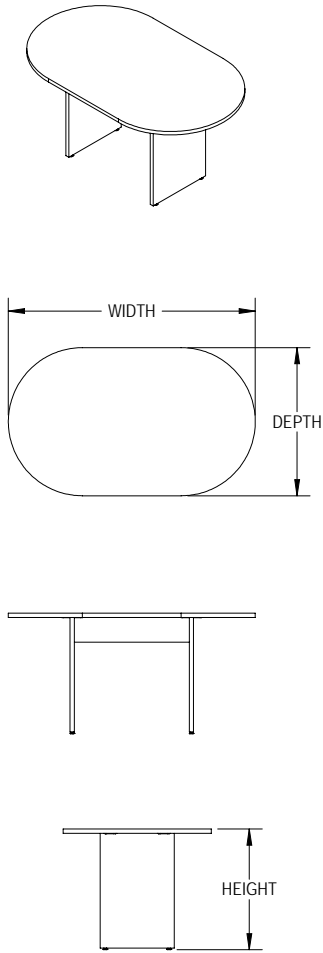

NOMINAL SIZE		POWER	LAMINATE		
WIDTH	DEPTH	QUANTITY	PRICE M1	PRICE H1	PRICE K1
60"	30"	0	\$1,646	\$1,969	\$2,556
72"	30"	0	\$1,671	\$1,992	\$2,581
60"	36"	1	\$1,637	\$1,940	\$2,481
72"	36"	1	\$1,672	\$1,994	\$2,583
72"	42"	1	\$1,674	\$1,996	\$2,587
78"	42"	1	\$1,689	\$2,011	\$2,603
84"	42"	1	\$1,924	\$2,245	\$2,839
90"	42"	1	\$1,939	\$2,260	\$2,855
96"	42"	1	\$1,951	\$2,272	\$2,868
72"	48"	1	\$1,707	\$2,030	\$2,620
78"	48"	1	\$1,722	\$2,043	\$2,639
84"	48"	1	\$1,956	\$2,279	\$2,873
90"	48"	1	\$1,973	\$2,294	\$2,890
96"	48"	1	\$1,983	\$2,306	\$2,901
72"	54"	1	\$1,743	\$2,064	\$2,658
78"	54"	1	\$1,757	\$2,080	\$2,673
84"	54"	1	\$1,992	\$2,314	\$2,910
90"	54"	1	\$2,006	\$2,328	\$2,926
96"	54"	1	\$2,017	\$2,340	\$2,939
72"	60"	1	\$1,773	\$2,096	\$2,690
78"	60"	1	\$1,788	\$2,109	\$2,706
84"	60"	1	\$2,024	\$2,345	\$2,941
90"	60"	1	\$2,038	\$2,360	\$2,959
96"	60"	1	\$2,051	\$2,371	\$2,971

**ORDER CODE SAMPLE**

LINE 1	TABLE	ITEM CODE	WIDTH	DEPTH	LAMINATE
		TPBET	W96	D48	M1
LINE 1.1	POWER & DATA	POWER OPTION	FINISH / TRIM FINISH / COVER CODE	BODY FINISH / OPTION	POWER QTY
		AF2RE	SLV	D	1

**Features & Specifications**

No Charge Options

Optional Extra

- Laminate codes - M1: 1" LPL, H1: 1" HPL, K1: 1.25" knife edge (top only)
- Base laminate is 1" LPL
- Height is 29" nominal, including levellers
- Available in all standard laminates
- For wire management please refer to BRC's accessories price guide

**POWER & DATA** For detailed specification, cover code finishes, data and telecom options, and pricing of each electrical modules please refer to page "Power & Data Options".

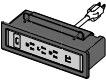
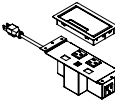
 <p><b>AF2RE</b></p>	<p><b>Finish:</b> Black (BLK), Silver (SLV), White (WHT), Anodized Aluminum (BAA), Stainless Steel (BSS)</p>	 <p><b>AF3AE</b></p>	<p><b>Trim Finish:</b> Black (BLK), Silver (SLV), White (WHT)</p>	 <p><b>AU2FE</b></p>	<p><b>Cover Code:</b> F-AL, F-S, F-B, F-W</p>
	<p><b>Option (Data &amp; Telecom):</b> A, B, C, D, E, F, G, H, J, K</p>		<p><b>Body Finish:</b> White (WHT), Gray (GRY), Black (BLK), Orange (ORN), Red (RED), Green (GRN), Blue (BLU)</p>		<p><b>Option (Data &amp; Telecom):</b> C, K</p>

# Racetrack Panel Base Table - 3 Base

TPBET

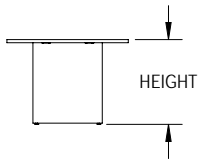
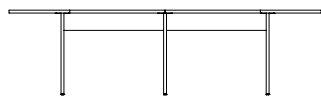
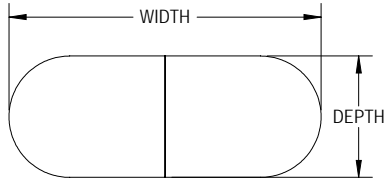
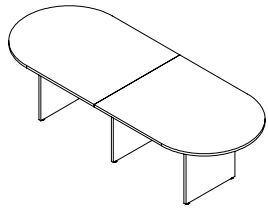

NOMINAL SIZE		POWER	LAMINATE		
WIDTH	DEPTH	QUANTITY	PRICE M1	PRICE H1	PRICE K1
108"	42"	1, 2	\$2,245	\$2,567	\$3,164
120"	42"	1, 2	\$3,034	\$3,679	\$4,847
132"	42"	1, 2	\$3,061	\$3,706	\$4,877
144"	42"	1, 2	\$3,087	\$3,731	\$4,906
108"	48"	1, 2	\$2,279	\$2,600	\$3,198
120"	48"	1, 2	\$3,067	\$3,712	\$4,882
132"	48"	1, 2	\$3,094	\$3,739	\$4,911
144"	48"	1, 2	\$3,121	\$3,765	\$4,939
108"	54"	1, 2	\$2,313	\$2,635	\$3,234
120"	54"	1, 2	\$3,103	\$3,746	\$4,919
132"	54"	1, 2	\$3,128	\$3,772	\$4,947
144"	54"	1, 2	\$3,155	\$3,799	\$4,976
108"	60"	1, 2	\$2,345	\$2,667	\$3,266
120"	60"	1, 2	\$3,133	\$3,778	\$4,950
132"	60"	1, 2	\$3,160	\$3,803	\$4,979
144"	60"	1, 2	\$3,186	\$3,830	\$5,009

**ORDER CODE SAMPLE**

LINE 1	TABLE	ITEM CODE	WIDTH	DEPTH	LAMINATE
		TPBET	W108	D48	M1
LINE 1.1	POWER & DATA	POWER OPTION	FINISH / TRIM FINISH / COVER CODE	BODY FINISH / OPTION	POWER QTY
		AF2RE	SLV	D	1

**Features & Specifications**

No Charge Options

Optional Extra

- Laminate codes - M1: 1" LPL, H1: 1" HPL, K1: 1.25" knife edge (top only)
- Base laminate is 1" LPL
- Height is 29" nominal, including levellers
- Available in all standard laminates
- For wire management please refer to BRC's accessories price guide

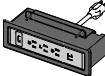
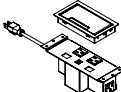
POWER & DATA					
For detailed specification, cover code finishes, data and telecom options, and pricing of each electrical modules please refer to page "Power & Data Options".					
<b>AF2RE</b> 	<b>Finish:</b> Black (BLK), Silver (SLV), White (WHT), Anodized Aluminum (BAA), Stainless Steel (BSS)	<b>AF3AE</b> 	<b>Trim Finish:</b> Black (BLK), Silver (SLV), White (WHT)	<b>AU2FE</b> 	<b>Cover Code:</b> F-AL, F-S, F-B, F-W
	<b>Option (Data &amp; Telecom):</b> A, B, C, D, E, F, G, H, J, K		<b>Body Finish:</b> White (WHT), Gray (GRY), Black (BLK), Orange (ORN), Red (RED), Green (GRN), Blue (BLU)		<b>Option (Data &amp; Telecom):</b> C, K

# Square Fit Table

TFSQT

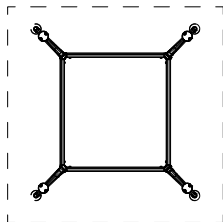
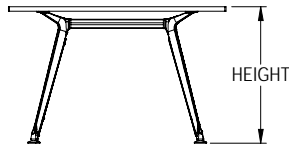
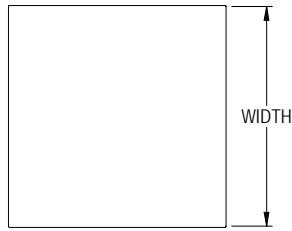
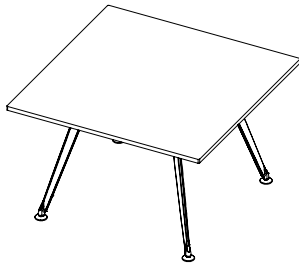

NOMINAL SIZE	POWER	LAMINATE				
		WIDTH	QUANTITY	PRICE M1	PRICE H1	PRICE K1
30"	1			\$1,198	\$1,415	\$1,802
36"	1			\$1,258	\$1,478	\$1,870
42"	1			\$1,318	\$1,541	\$1,936
48"	1			\$1,405	\$1,642	\$2,058
60"	1			\$1,673	\$1,992	\$2,487

**ORDER CODE SAMPLE**

LINE 1	TABLE	ITEM CODE	WIDTH	LAMINATE	OPTION
		TFSQT	W42	M1	CC
LINE 1.1	POWER & DATA	POWER OPTION	FINISH / TRIM FINISH / COVER CODE	BODY FINISH / OPTION	POWER QTY
		AF2RE	SLV	D	1

**Features & Specifications**

No Charge Options

Optional Extra

- Laminate codes - M1: 1" LPL, H1: 1" HPL, K1: 1.25" knife edge (top only)
- Base legs available in chrome only; upper frames are black
- Height is 29" nominal, including levellers
- Available in all standard laminates
- For 3" curved corners add option code "CC" and \$349

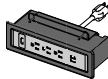
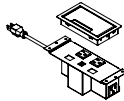
POWER & DATA	For detailed specification, cover code finishes, data and telecom options, and pricing of each electrical modules please refer to page "Power & Data Options".				
<b>AF2RE</b> 	<b>Finish:</b> Black (BLK), Silver (SLV), White (WHT), Anodized Aluminum (BAA), Stainless Steel (BSS)	<b>AF3AE</b> 	<b>Trim Finish:</b> Black (BLK), Silver (SLV), White (WHT)	<b>AU2FE</b> 	<b>Cover Code:</b> F-AL, F-S, F-B, F-W
	<b>Option (Data &amp; Telecom):</b> A, B, C, D, E, F, G, H, J, K		<b>Body Finish:</b> White (WHT), Gray (GRY), Black (BLK), Orange (ORN), Red (RED), Green (GRN), Blue (BLU)		<b>Option (Data &amp; Telecom):</b> C, K

# Round Fit Table

TFRDT

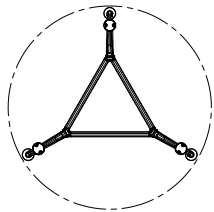
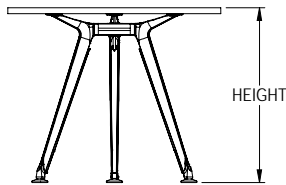
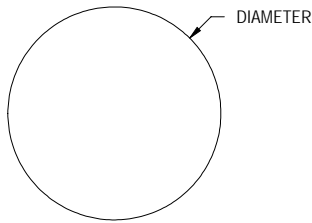
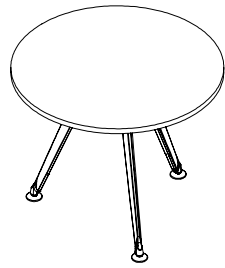

NOMINAL SIZE	POWER	LAMINATE			
		DIAMETER	QUANTITY	PRICE M1	PRICE H1
30"	1		\$1,266	\$1,481	\$1,870
36"	1		\$1,388	\$1,658	\$2,139
42"	1		\$1,449	\$1,723	\$2,209
48"	1		\$1,540	\$1,828	\$2,339
60"	1		\$1,829	\$2,208	\$2,760

**ORDER CODE SAMPLE**

LINE 1	TABLE	ITEM CODE	WIDTH	LAMINATE	
		TFRDT	W42	M1	
LINE 1.1	POWER & DATA	POWER OPTION	FINISH / TRIM FINISH / COVER CODE	BODY FINISH / OPTION	POWER QTY
		AF2RE	SLV	D	1

**Features & Specifications**

No Charge Options

- Laminate codes - M1: 1" LPL, H1: 1" HPL, K1: 1.25" knife edge (top only)
- Base legs available in chrome only; upper frames are black
- Height is 29" nominal, including levellers
- Available in all standard laminates

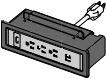
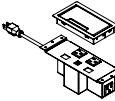
POWER & DATA					
For detailed specification, cover code finishes, data and telecom options, and pricing of each electrical modules please refer to page "Power & Data Options".					
<b>AF2RE</b> 	<b>Finish:</b> Black (BLK), Silver (SLV), White (WHT), Anodized Aluminum (BAA), Stainless Steel (BSS)	<b>AF3AE</b> 	<b>Trim Finish:</b> Black (BLK), Silver (SLV), White (WHT)	<b>AU2FE</b> 	<b>Cover Code:</b> F-AL, F-S, F-B, F-W
	<b>Option (Data &amp; Telecom):</b> A, B, C, D, E, F, G, H, J, K		<b>Body Finish:</b> White (WHT), Gray (GRY), Black (BLK), Orange (ORN), Red (RED), Green (GRN), Blue (BLU)		<b>Option (Data &amp; Telecom):</b> C, K

PRODUCT MAP  
CONFERENCE TABLES  
MEDIA TABLES  
PARSONS TABLES  
MEETING & CASUAL TABLES  
NEST TRAINING TABLES  
www.brc.group

# Square Nova Table

TNSQT

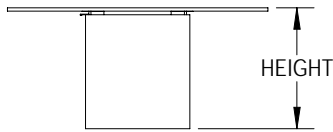
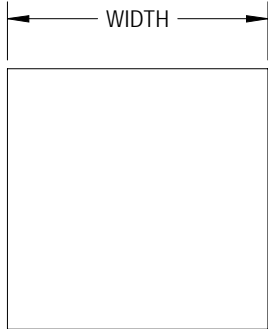
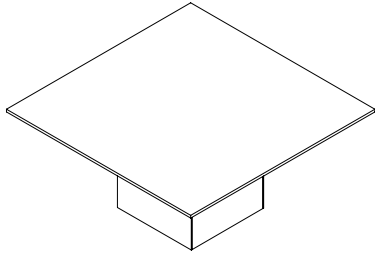

NOMINAL SIZE	POWER	LAMINATE		
WIDTH	QUANTITY	PRICE M1	PRICE H1	PRICE K1
60"	1	\$2,460	\$2,779	\$3,274

**ORDER CODE SAMPLE**

LINE 1	TABLE	ITEM CODE	WIDTH	LAMINATE	OPTION
		TNSQT	W60	M1	CC
LINE 1.1	POWER & DATA	POWER OPTION	FINISH / TRIM FINISH / COVER CODE	BODY FINISH / OPTION	POWER QTY
		AF2RE	SLV	D	1

**Features & Specifications**

No Charge Options  
Optional Extra

- Laminate codes - M1: 1" LPL, H1: 1" HPL, K1: 1.25" knife edge (top only)
- Base laminate is 3/4" LPL
- Wire management in each leg
- Height is 29" nominal, including levelers
- Available in all standard laminates
- For 3" curved corners add option code "CC" and \$349

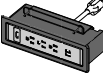
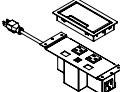
POWER & DATA	For detailed specification, cover code finishes, data and telecom options, and pricing of each electrical modules please refer to page "Power & Data Options".				
 <p><b>AF2RE</b></p>	<p><b>Finish:</b> Black (BLK), Silver (SLV), White (WHT), Anodized Aluminum (BAA), Stainless Steel (BSS)</p>	 <p><b>AF3AE</b></p>	<p><b>Trim Finish:</b> Black (BLK), Silver (SLV), White (WHT)</p>	 <p><b>AU2FE</b></p>	<p><b>Cover Code:</b> F-AL, F-S, F-B, F-W</p>
	<p><b>Option (Data &amp; Telecom):</b> A, B, C, D, E, F, G, H, J, K</p>		<p><b>Body Finish:</b> White (WHT), Gray (GRY), Black (BLK), Orange (ORN), Red (RED), Green (GRN), Blue (BLU)</p>		<p><b>Option (Data &amp; Telecom):</b> C, K</p>

PRODUCT MAP  
CONFERENCE TABLES  
MEDIA TABLES  
PARSONS TABLES  
MEETING & CASUAL TABLES  
NEST TRAINING TABLES  
www.brc.group

# Round Nova Table

TNSRT

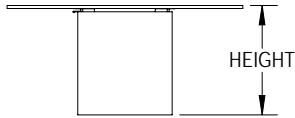
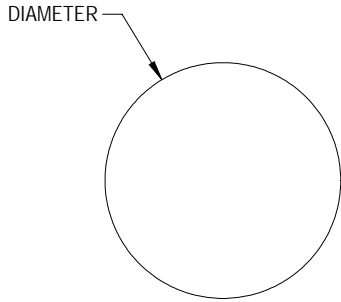
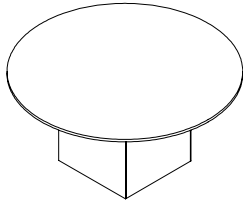

NOMINAL SIZE	POWER	LAMINATE		
DIAMETER	QUANTITY	PRICE M1	PRICE H1	PRICE K1
60"	1	\$2,616	\$2,994	\$3,547

**ORDER CODE SAMPLE**

LINE 1	TABLE	ITEM CODE	WIDTH	LAMINATE	
		TNSRT	W60	M1	
LINE 1.1	POWER & DATA	POWER OPTION	FINISH / TRIM FINISH / COVER CODE	BODY FINISH / OPTION	POWER QTY
		AF2RE	SLV	D	1

**Features & Specifications**

**No Charge Options**

- Laminate codes - M1: 1" LPL, H1: 1" HPL, K1: 1.25" knife edge (top only)
- Base laminate is 3/4" LPL
- Wire management in each leg
- Height is 29" nominal, including levelers
- Available in all standard laminates

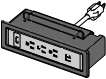
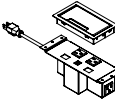
<b>POWER &amp; DATA</b>					
For detailed specification, cover code finishes, data and telecom options, and pricing of each electrical modules please refer to page "Power & Data Options".					
 <b>AF2RE</b>	<b>Finish:</b> Black (BLK), Silver (SLV), White (WHT), Anodized Aluminum (BAA), Stainless Steel (BSS)	 <b>AF3AE</b>	<b>Trim Finish:</b> Black (BLK), Silver (SLV), White (WHT)	 <b>AU2FE</b>	<b>Cover Code:</b> F-AL, F-S, F-B, F-W
	<b>Option (Data &amp; Telecom):</b> A, B, C, D, E, F, G, H, J, K		<b>Body Finish:</b> White (WHT), Gray (GRY), Black (BLK), Orange (ORN), Red (RED), Green (GRN), Blue (BLU)		<b>Option (Data &amp; Telecom):</b> C, K

# Arced Square Nova Table

TNSAT

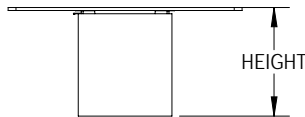
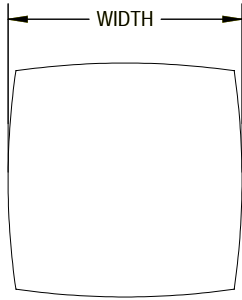
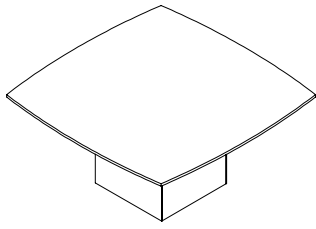

NOMINAL SIZE	POWER	LAMINATE		
WIDTH	QUANTITY	PRICE M1	PRICE H1	PRICE K1
60"	1	\$2,541	\$2,893	\$3,436

**ORDER CODE SAMPLE**

LINE 1	TABLE	ITEM CODE	WIDTH	LAMINATE	OPTION
		TNSAT	W60	M1	CC
LINE 1.1	POWER & DATA	POWER OPTION	FINISH / TRIM FINISH / COVER CODE	BODY FINISH / OPTION	POWER QTY
		AF2RE	SLV	D	1

**Features & Specifications**

No Charge Options  
Optional Extra

- Laminate codes - M1: 1" LPL, H1: 1" HPL, K1: 1.25" knife edge (top only)
- Base laminate is 3/4" LPL
- Wire management in each leg
- Height is 29" nominal, including levelers
- Available in all standard laminates
- For 3" curved corners add option code "CC" and \$349

**POWER & DATA** For detailed specification, cover code finishes, data and telecom options, and pricing of each electrical modules please refer to page "Power & Data Options".

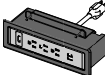
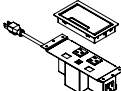
 <p><b>AF2RE</b></p>	<p><b>Finish:</b> Black (BLK), Silver (SLV), White (WHT), Anodized Aluminum (BAA), Stainless Steel (BSS)</p>	 <p><b>AF3AE</b></p>	<p><b>Trim Finish:</b> Black (BLK), Silver (SLV), White (WHT)</p>	 <p><b>AU2FE</b></p>	<p><b>Cover Code:</b> F-AL, F-S, F-B, F-W</p>
	<p><b>Option (Data &amp; Telecom):</b> A, B, C, D, E, F, G, H, J, K</p>		<p><b>Body Finish:</b> White (WHT), Gray (GRY), Black (BLK), Orange (ORN), Red (RED), Green (GRN), Blue (BLU)</p>		<p><b>Option (Data &amp; Telecom):</b> C, K</p>

PRODUCT MAP  
CONFERENCE TABLES  
MEDIA TABLES  
PARSONS TABLES  
MEETING & CASUAL TABLES  
NEST TRAINING TABLES  
www.brc.group

# Square Panel Base Table

TPSQT

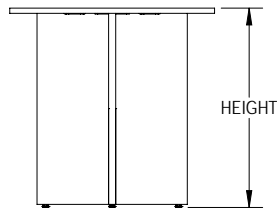
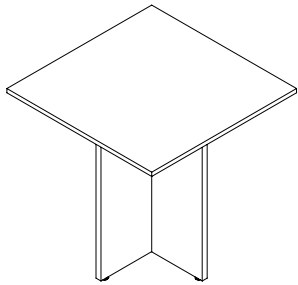

NOMINAL SIZE	LAMINATE			
	WIDTH	PRICE M1	PRICE H1	PRICE K1
30"		\$1,352	\$1,730	\$2,139
36"		\$1,510	\$1,741	\$2,154
42"		\$1,560	\$1,796	\$2,214
48"		\$1,641	\$1,889	\$2,334
60"		\$1,956	\$2,293	\$2,817

**ORDER CODE SAMPLE**

LINE 1	TABLE	ITEM CODE	WIDTH	LAMINATE	OPTION
		TPSQT	W36	M1	CC

**Features & Specifications**

No Charge Options

Optional Extra

- Laminate codes - M1: 1" LPL, H1: 1" HPL, K1: 1.25" knife edge (top only)
- Base laminate is 1" LPL
- Height is 29" nominal, including levellers
- Available in all standard laminates
- For 3" curved corners add option code "CC" and \$349

# Round Panel Base Table

TPRDT

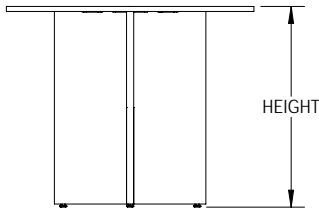
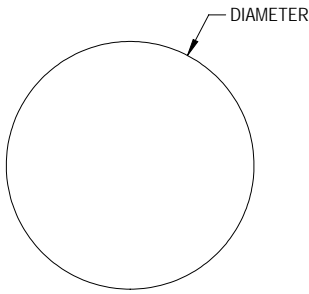
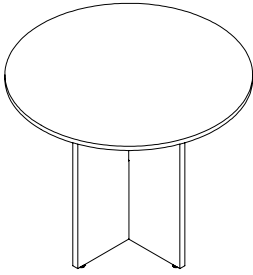

NOMINAL SIZE	LAMINATE		
	DIAMETER	PRICE M1	PRICE H1
36"	\$1,483	\$1,740	\$2,198
42"	\$1,530	\$1,790	\$2,254
48"	\$1,606	\$1,879	\$2,366
60"	\$1,911	\$2,272	\$2,797

**ORDER CODE SAMPLE**

LINE 1	TABLE	ITEM CODE	WIDTH	LAMINATE
		TPRDT	W36	M1

**Features & Specifications**

**No Charge Options**

- Laminate codes - M1: 1" LPL, H1: 1" HPL, K1: 1.25" knife edge (top only)
- Base laminate is 1" LPL
- Height is 29" nominal, including levellers
- Available in all standard laminates

PRODUCT MAP

CONFERENCE TABLES

MEDIA TABLES

PARSONS TABLES

MEETING & CASUAL TABLES

NEST TRAINING TABLES

www.brc.group

# Wall-Mount Rectangular Fit Table

TFRWT

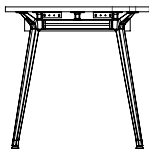
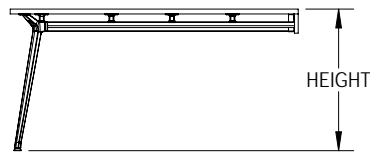
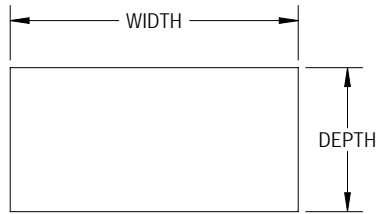
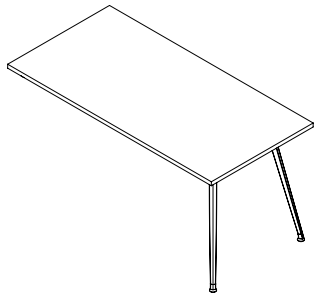

NOMINAL SIZE		TOP	POWER	LAMINATE		
WIDTH	DEPTH	SECTIONS	QUANTITY	PRICE M1	PRICE H1	PRICE K1
60"	30"	1	0	\$1,590	\$1,871	\$2,494
72"	30"	1	0	\$1,604	\$1,888	\$2,497
60"	36"	1	1	\$1,616	\$1,906	\$2,423
72"	36"	1	1	\$1,631	\$1,926	\$2,499
72"	42"	1	1	\$1,631	\$1,926	\$2,501
78"	42"	1	1	\$1,663	\$1,962	\$2,531
84"	42"	1	1	\$1,691	\$1,989	\$2,558
90"	42"	1	1	\$1,724	\$2,024	\$2,592
96"	42"	1	1	\$1,751	\$2,052	\$2,619
72"	48"	1	1	\$1,658	\$1,953	\$2,530
78"	48"	1	1	\$1,691	\$1,989	\$2,563
84"	48"	1	1	\$1,718	\$2,015	\$2,590
90"	48"	1	1	\$1,751	\$2,052	\$2,621
96"	48"	1	1	\$1,778	\$2,078	\$2,648
72"	54"	1	1	\$1,684	\$1,980	\$2,563
78"	54"	1	1	\$1,718	\$2,015	\$2,595
84"	54"	1	1	\$1,745	\$2,042	\$2,621
90"	54"	1	1	\$1,778	\$2,078	\$2,653
96"	54"	1	1	\$1,804	\$2,105	\$2,680
72"	60"	1	1	\$1,711	\$2,006	\$2,590
78"	60"	1	1	\$1,745	\$2,042	\$2,621
84"	60"	1	1	\$1,772	\$2,068	\$2,648
90"	60"	1	1	\$1,804	\$2,105	\$2,680
96"	60"	1	1	\$1,832	\$2,132	\$2,707

**ORDER CODE SAMPLE**

LINE 1	TABLE	ITEM CODE	WIDTH	DEPTH	LAMINATE	OPTION
		TFRWT	W96	D48	M1	CC
LINE 1.1	POWER & DATA	POWER OPTION	FINISH / TRIM FINISH / COVER CODE	BODY FINISH / OPTION	POWER QTY	
		AF2RE	SLV	D	1	

**Features & Specifications**

No Charge Options  
Optional Extra

- Laminate codes - M1: 1" LPL, H1: 1" HPL, K1: 1.25" knife edge (top only)
- Base legs available in chrome only; upper frames are black
- Height is 29" nominal, including levellers, including levellers
- Available in all standard laminates
- For 3" curved corners add option code "CC" and \$349
- For 3" center grommet (AG30A) add option code "GC" and \$76

**POWER & DATA** For detailed specification, cover code finishes, data and telecom options, and pricing of each electrical modules please refer to page "Power & Data Options".

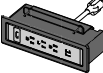
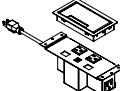
 <p><b>AF2RE</b></p>	<p><b>Finish:</b> Black (BLK), Silver (SLV), White (WHT), Anodized Aluminum (BAA), Stainless Steel (BSS)</p>	 <p><b>AF3AE</b></p>	<p><b>Trim Finish:</b> Black (BLK), Silver (SLV), White (WHT)</p>	 <p><b>AU2FE</b></p>	<p><b>Cover Code:</b> F-AL, F-S, F-B, F-W</p>
	<p><b>Option (Data &amp; Telecom):</b> A, B, C, D, E, F, G, H, J, K</p>		<p><b>Body Finish:</b> White (WHT), Gray (GRY), Black (BLK), Orange (ORN), Red (RED), Green (GRN), Blue (BLU)</p>		<p><b>Option (Data &amp; Telecom):</b> C, K</p>

PRODUCT MAP  
CONFERENCE TABLES  
MEDIA TABLES  
PARSONS TABLES  
MEETING & CASUAL TABLES  
NEST TRAINING TABLES  
www.brc.group

# Wall-Mount Arc End Rectangular Fit Table

TFAWT

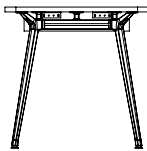
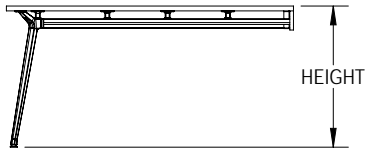
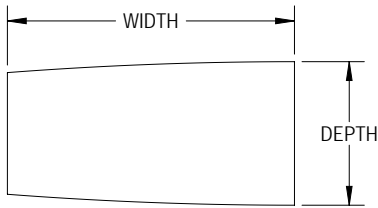
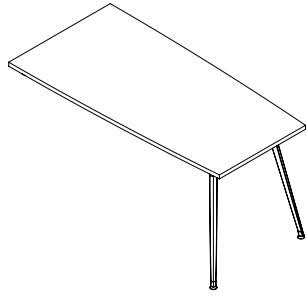

NOMINAL SIZE		TOP	POWER	LAMINATE		
WIDTH	DEPTH	SECTIONS	QUANTITY	PRICE M1	PRICE H1	PRICE K1
60"	30"	1	0	\$1,700	\$2,040	\$2,656
72"	30"	1	0	\$1,702	\$2,041	\$2,658
60"	36"	1	1	\$1,691	\$2,011	\$2,578
72"	36"	1	1	\$1,705	\$2,042	\$2,660
72"	42"	1	1	\$1,707	\$2,043	\$2,665
78"	42"	1	1	\$1,737	\$2,073	\$2,697
84"	42"	1	1	\$1,763	\$2,101	\$2,723
90"	42"	1	1	\$1,793	\$2,131	\$2,756
96"	42"	1	1	\$1,820	\$2,157	\$2,782
72"	48"	1	1	\$1,734	\$2,072	\$2,693
78"	48"	1	1	\$1,764	\$2,103	\$2,726
84"	48"	1	1	\$1,791	\$2,129	\$2,753
90"	48"	1	1	\$1,822	\$2,158	\$2,784
96"	48"	1	1	\$1,849	\$2,185	\$2,811
72"	54"	1	1	\$1,764	\$2,103	\$2,726
78"	54"	1	1	\$1,794	\$2,134	\$2,758
84"	54"	1	1	\$1,822	\$2,158	\$2,784
90"	54"	1	1	\$1,852	\$2,191	\$2,818
96"	54"	1	1	\$1,879	\$2,217	\$2,844
72"	60"	1	1	\$1,791	\$2,129	\$2,753
78"	60"	1	1	\$1,822	\$2,158	\$2,784
84"	60"	1	1	\$1,849	\$2,185	\$2,811
90"	60"	1	1	\$1,879	\$2,217	\$2,844
96"	60"	1	1	\$1,905	\$2,244	\$2,871

**ORDER CODE SAMPLE**

LINE 1	TABLE	ITEM CODE	WIDTH	DEPTH	LAMINATE	OPTION
		TFAWT	W96	D48	M1	CC
LINE 1.1	POWER & DATA	POWER OPTION	FINISH / TRIM FINISH / COVER CODE	BODY FINISH / OPTION	POWER QTY	
		AF2RE	SLV	D	1	

**Features & Specifications**

No Charge Options  
Optional Extra

- Laminate codes - M1: 1" LPL, H1: 1" HPL, K1: 1.25" knife edge (top only)
- Base legs available in chrome only; upper frames are black
- Height is 29" nominal, including levellers, including levellers
- Available in all standard laminates
- For 3" curved corners add option code "CC" and \$349
- For 3" center grommet (AG30A) add option code "GC" and \$76

**POWER & DATA** For detailed specification, cover code finishes, data and telecom options, and pricing of each electrical modules please refer to page "Power & Data Options".

 <p><b>AF2RE</b></p>	<p><b>Finish:</b> Black (BLK), Silver (SLV), White (WHT), Anodized Aluminum (BAA), Stainless Steel (BSS)</p>	 <p><b>AF3AE</b></p>	<p><b>Trim Finish:</b> Black (BLK), Silver (SLV), White (WHT)</p>	 <p><b>AU2FE</b></p>	<p><b>Cover Code:</b> F-AL, F-S, F-B, F-W</p>
	<p><b>Option (Data &amp; Telecom):</b> A, B, C, D, E, F, G, H, J, K</p>		<p><b>Body Finish:</b> White (WHT), Gray (GRY), Black (BLK), Orange (ORN), Red (RED), Green (GRN), Blue (BLU)</p>		<p><b>Option (Data &amp; Telecom):</b> C, K</p>

# Wall-Mount Bullet End Fit Table

TFCWT

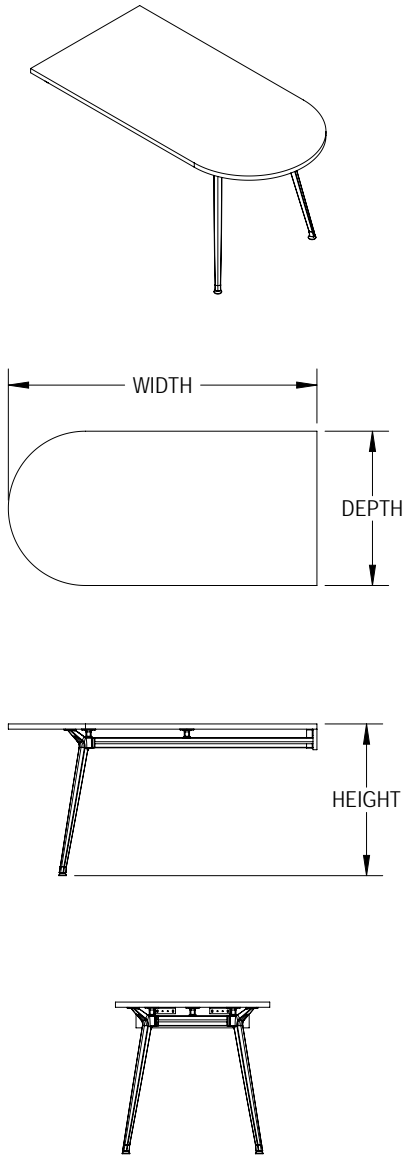

NOMINAL SIZE		TOP	POWER	LAMINATE		
WIDTH	DEPTH	SECTIONS	QUANTITY	PRICE M1	PRICE H1	PRICE K1
60"	30"	1	0	\$1,599	\$1,936	\$2,553
72"	30"	1	0	\$1,601	\$1,937	\$2,556
60"	36"	1	1	\$1,587	\$1,906	\$2,475
72"	36"	1	1	\$1,603	\$1,940	\$2,558
72"	42"	1	1	\$1,558	\$1,896	\$2,517
78"	42"	1	1	\$1,589	\$1,927	\$2,549
84"	42"	1	1	\$1,660	\$1,996	\$2,621
90"	42"	1	1	\$1,691	\$2,030	\$2,653
96"	42"	1	1	\$1,718	\$2,056	\$2,680
72"	48"	1	1	\$1,586	\$1,925	\$2,546
78"	48"	1	1	\$1,618	\$1,955	\$2,578
84"	48"	1	1	\$1,688	\$2,027	\$2,651
90"	48"	1	1	\$1,720	\$2,057	\$2,682
96"	48"	1	1	\$1,747	\$2,084	\$2,709
72"	54"	1	1	\$1,618	\$1,955	\$2,578
78"	54"	1	1	\$1,647	\$1,985	\$2,609
84"	54"	1	1	\$1,720	\$2,057	\$2,682
90"	54"	1	1	\$1,749	\$2,087	\$2,716
96"	54"	1	1	\$1,775	\$2,114	\$2,742
72"	60"	1	1	\$1,644	\$1,982	\$2,605
78"	60"	1	1	\$1,673	\$2,012	\$2,636
84"	60"	1	1	\$1,747	\$2,084	\$2,709
90"	60"	1	1	\$1,775	\$2,114	\$2,742
96"	60"	1	1	\$1,802	\$2,141	\$2,769

**ORDER CODE SAMPLE**

LINE 1	TABLE	ITEM CODE	WIDTH	DEPTH	LAMINATE
		TFCWT	W96	D48	M1
LINE 1.1	POWER & DATA	POWER OPTION	FINISH / TRIM FINISH / COVER CODE	BODY FINISH / OPTION	POWER QTY
		AF2RE	SLV	D	1

**Features & Specifications**

No Charge Options  
Optional Extra

- Laminate codes - M1: 1" LPL, H1: 1" HPL, K1: 1.25" knife edge (top only)
- Base legs available in chrome only; upper frames are black
- Height is 29" nominal, including levellers, including levellers
- Available in all standard laminates
- For 3" center grommet (AG30A) add option code "GC" and \$76

**POWER & DATA** For detailed specification, cover code finishes, data and telecom options, and pricing of each electrical modules please refer to page "Power & Data Options".

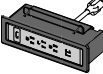
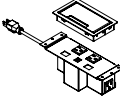
<b>AF2RE</b> 	<b>Finish:</b> Black (BLK), Silver (SLV), White (WHT), Anodized Aluminum (BAA), Stainless Steel (BSS)  <b>Option (Data &amp; Telecom):</b> A, B, C, D, E, F, G, H, J, K	<b>AF3AE</b> 	<b>Trim Finish:</b> Black (BLK), Silver (SLV), White (WHT)  <b>Body Finish:</b> White (WHT), Gray (GRY), Black (BLK), Orange (ORN), Red (RED), Green (GRN), Blue (BLU)	<b>AU2FE</b> 	<b>Cover Code:</b> F-AL, F-S, F-B, F-W  <b>Option (Data &amp; Telecom):</b> C, K
---	---	---	--	---	--

PRODUCT MAP  
CONFERENCE TABLES  
MEDIA TABLES  
PARSONS TABLES  
MEETING & CASUAL TABLES  
NEST TRAINING TABLES  
www.brc.group

# Wall-Mount Arced Boat Fit Table

TFBWT

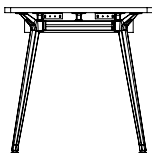
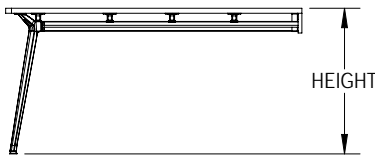
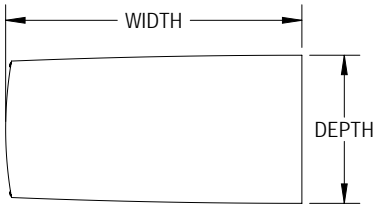
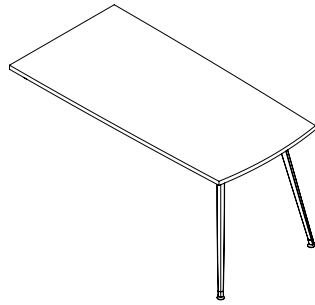

NOMINAL SIZE		TOP	POWER	LAMINATE		
WIDTH	DEPTH	SECTIONS	QUANTITY	PRICE M1	PRICE H1	PRICE K1
60"	30"	1	0	\$1,700	\$2,040	\$2,656
72"	30"	1	0	\$1,702	\$2,041	\$2,658
60"	36"	1	1	\$1,691	\$2,011	\$2,578
72"	36"	1	1	\$1,705	\$2,042	\$2,660
72"	42"	1	1	\$1,707	\$2,043	\$2,665
78"	42"	1	1	\$1,737	\$2,073	\$2,697
84"	42"	1	1	\$1,763	\$2,101	\$2,723
90"	42"	1	1	\$1,793	\$2,131	\$2,756
96"	42"	1	1	\$1,820	\$2,157	\$2,782
72"	48"	1	1	\$1,734	\$2,072	\$2,693
78"	48"	1	1	\$1,764	\$2,103	\$2,726
84"	48"	1	1	\$1,791	\$2,129	\$2,753
90"	48"	1	1	\$1,822	\$2,158	\$2,784
96"	48"	1	1	\$1,849	\$2,185	\$2,811
72"	54"	1	1	\$1,764	\$2,103	\$2,726
78"	54"	1	1	\$1,794	\$2,134	\$2,758
84"	54"	1	1	\$1,822	\$2,158	\$2,784
90"	54"	1	1	\$1,852	\$2,191	\$2,818
96"	54"	1	1	\$1,879	\$2,217	\$2,844
72"	60"	1	1	\$1,791	\$2,129	\$2,753
78"	60"	1	1	\$1,822	\$2,158	\$2,784
84"	60"	1	1	\$1,849	\$2,185	\$2,811
90"	60"	1	1	\$1,879	\$2,217	\$2,844
96"	60"	1	1	\$1,905	\$2,244	\$2,871

**ORDER CODE SAMPLE**

LINE 1	TABLE	ITEM CODE	WIDTH	DEPTH	LAMINATE	OPTION
		TFBWT	W96	D48	M1	CC
LINE 1.1	POWER & DATA	POWER OPTION	FINISH / TRIM FINISH / COVER CODE	BODY FINISH / OPTION	POWER QTY	
		AF2RE	SLV	D	1	

**Features & Specifications**

No Charge Options  
Optional Extra

- Laminate codes - M1: 1" LPL, H1: 1" HPL, K1: 1.25" knife edge (top only)
- Base legs available in chrome only; upper frames are black
- Height is 29" nominal, including levellers, including levellers
- Available in all standard laminates
- For 3" curved corners add option code "CC" and \$349
- For 3" center grommet (AG30A) add option code "GC" and \$76

**POWER & DATA** For detailed specification, cover code finishes, data and telecom options, and pricing of each electrical modules please refer to page "Power & Data Options".

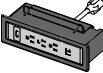
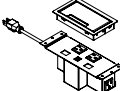
 <p><b>AF2RE</b></p>	<p><b>Finish:</b> Black (BLK), Silver (SLV), White (WHT), Anodized Aluminum (BAA), Stainless Steel (BSS)</p>	 <p><b>AF3AE</b></p>	<p><b>Trim Finish:</b> Black (BLK), Silver (SLV), White (WHT)</p>	 <p><b>AU2FE</b></p>	<p><b>Cover Code:</b> F-AL, F-S, F-B, F-W</p>
	<p><b>Option (Data &amp; Telecom):</b> A, B, C, D, E, F, G, H, J, K</p>		<p><b>Body Finish:</b> White (WHT), Gray (GRY), Black (BLK), Orange (ORN), Red (RED), Green (GRN), Blue (BLU)</p>		<p><b>Option (Data &amp; Telecom):</b> C, K</p>

# Wall-Mount Trapezoid Fit Table

TFZWT

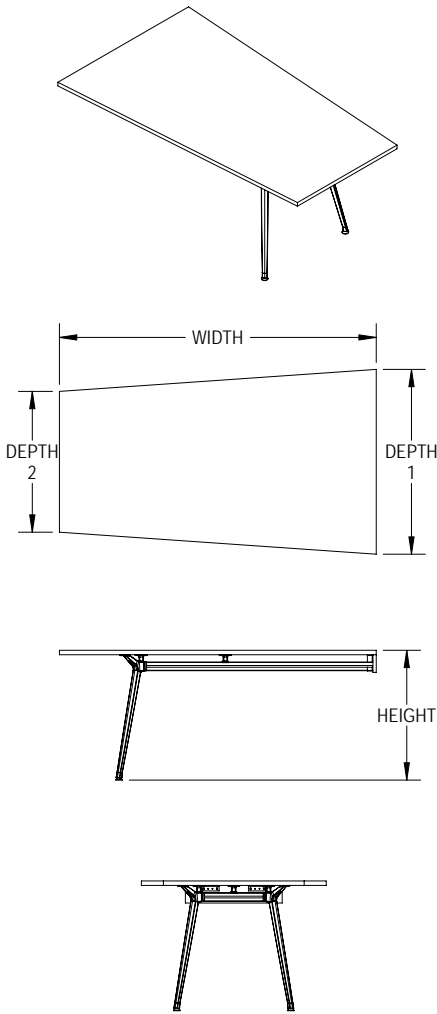

NOMINAL SIZE			TOP	POWER	LAMINATE		
WIDTH	DEPTH 1	DEPTH 2	SECTIONS	QUANTITY	PRICE M1	PRICE H1	PRICE K1
72"	42"	32"	1	1	\$1,558	\$1,896	\$2,517
78"	42"	32"	1	1	\$1,589	\$1,927	\$2,549
84"	42"	32"	1	1	\$1,660	\$1,996	\$2,621
90"	42"	32"	1	1	\$1,691	\$2,030	\$2,653
96"	42"	32"	1	1	\$1,718	\$2,056	\$2,680
72"	48"	38"	1	1	\$1,586	\$1,925	\$2,546
78"	48"	38"	1	1	\$1,618	\$1,955	\$2,578
84"	48"	38"	1	1	\$1,688	\$2,027	\$2,651
90"	48"	38"	1	1	\$1,720	\$2,057	\$2,682
96"	48"	38"	1	1	\$1,747	\$2,084	\$2,709
72"	54"	44"	1	1	\$1,618	\$1,955	\$2,578
78"	54"	44"	1	1	\$1,647	\$1,985	\$2,609
84"	54"	44"	1	1	\$1,720	\$2,057	\$2,682
90"	54"	44"	1	1	\$1,749	\$2,087	\$2,716
96"	54"	44"	1	1	\$1,775	\$2,114	\$2,742
72"	60"	50"	1	1	\$1,644	\$1,982	\$2,605
78"	60"	50"	1	1	\$1,673	\$2,012	\$2,636
84"	60"	50"	1	1	\$1,747	\$2,084	\$2,709
90"	60"	50"	1	1	\$1,775	\$2,114	\$2,742
96"	60"	50"	1	1	\$1,802	\$2,141	\$2,769

**ORDER CODE SAMPLE**

LINE 1	TABLE	ITEM CODE	WIDTH	DEPTH 1	DEPTH 2	LAMINATE	OPTION
		TFZWT	W96	D48	D38	M1	CC
LINE 1.1	POWER & DATA	POWER OPTION	FINISH / TRIM FINISH / COVER CODE	BODY FINISH / OPTION		POWER QTY	
		AF2RE	SLV	D		1	

**Features & Specifications**

No Charge Options  
Optional Extra

- Laminate codes - M1: 1" LPL, H1: 1" HPL, K1: 1.25" knife edge (top only)
- Base legs available in chrome only; upper frames are black
- Height is 29" nominal, including levellers, including levellers
- Available in all standard laminates
- For 3" curved corners add option code "CC" and \$349
- For 3" center grommet (AG30A) add option code "GC" and \$76

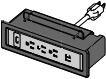
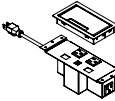
POWER & DATA	For detailed specification, cover code finishes, data and telecom options, and pricing of each electrical modules please refer to page "Power & Data Options".				
<b>AF2RE</b> 	<b>Finish:</b> Black (BLK), Silver (SLV), White (WHT), Anodized Aluminum (BAA), Stainless Steel (BSS)	<b>AF3AE</b> 	<b>Trim Finish:</b> Black (BLK), Silver (SLV), White (WHT)	<b>AU2FE</b> 	<b>Cover Code:</b> F-AL, F-S, F-B, F-W
	<b>Option (Data &amp; Telecom):</b> A, B, C, D, E, F, G, H, J, K		<b>Body Finish:</b> White (WHT), Gray (GRY), Black (BLK), Orange (ORN), Red (RED), Green (GRN), Blue (BLU)		<b>Option (Data &amp; Telecom):</b> C, K

PRODUCT MAP  
CONFERENCE TABLES  
MEDIA TABLES  
PARSONS TABLES  
MEETING & CASUAL TABLES  
NEST TRAINING TABLES  
www.brc.group

# Wall-Mount Rectangular Nova Table

TNWRT

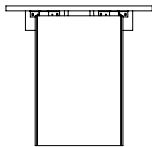
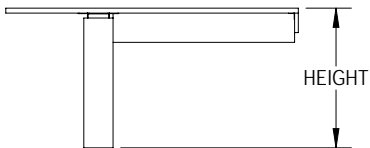
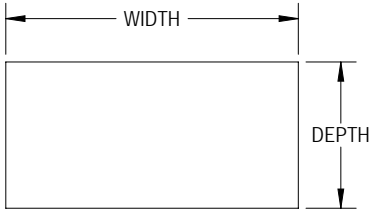
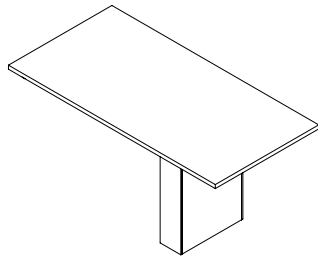

NOMINAL SIZE		TOP	POWER	LAMINATE		
WIDTH	DEPTH	SECTIONS	QUANTITY	PRICE M1	PRICE H1	PRICE K1
60"	30"	1	0	\$2,340	\$2,550	\$3,019
72"	30"	1	0	\$2,351	\$2,566	\$3,022
60"	36"	1	1	\$2,467	\$2,683	\$3,073
72"	36"	1	1	\$2,477	\$2,699	\$3,130
72"	42"	1	1	\$2,477	\$2,699	\$3,131
78"	42"	1	1	\$2,482	\$2,706	\$3,134
84"	42"	1	1	\$2,482	\$2,706	\$3,134
90"	42"	1	1	\$2,489	\$2,712	\$3,138
96"	42"	1	1	\$2,489	\$2,712	\$3,138
72"	48"	1	1	\$2,477	\$2,699	\$3,133
78"	48"	1	1	\$2,482	\$2,706	\$3,137
84"	48"	1	1	\$2,482	\$2,706	\$3,137
90"	48"	1	1	\$2,489	\$2,712	\$3,140
96"	48"	1	1	\$2,489	\$2,712	\$3,140
72"	54"	1	1	\$2,583	\$2,807	\$3,243
78"	54"	1	1	\$2,590	\$2,812	\$3,246
84"	54"	1	1	\$2,590	\$2,812	\$3,246
90"	54"	1	1	\$2,595	\$2,820	\$3,252
96"	54"	1	1	\$2,595	\$2,820	\$3,252
72"	60"	1	1	\$2,583	\$2,807	\$3,243
78"	60"	1	1	\$2,590	\$2,812	\$3,246
84"	60"	1	1	\$2,590	\$2,812	\$3,246
90"	60"	1	1	\$2,595	\$2,820	\$3,252
96"	60"	1	1	\$2,595	\$2,820	\$3,252

**ORDER CODE SAMPLE**

LINE 1	TABLE	ITEM CODE	WIDTH	DEPTH	LAMINATE	OPTION
		TNWRT	W96	D48	M1	CC
LINE 1.1	POWER & DATA	POWER OPTION	FINISH / TRIM FINISH / COVER CODE	BODY FINISH / OPTION	POWER QTY	
		AF2RE	SLV	D	1	

**Features & Specifications**

No Charge Options  
Optional Extra

- Laminate codes - M1: 1" LPL, H1: 1" HPL, K1: 1.25" knife edge (top only)
- Base laminate is 3/4" LPL
- Wire management in each leg
- Height is 29" nominal, including levellers, including levellers
- Available in all standard laminates
- For 3" curved corners add option code "CC" and \$349
- For 3" center grommet (AG30A) add option code "GC" and \$76

**POWER & DATA** For detailed specification, cover code finishes, data and telecom options, and pricing of each electrical modules please refer to page "Power & Data Options".

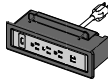
 <p><b>AF2RE</b></p>	<p><b>Finish:</b> Black (BLK), Silver (SLV), White (WHT), Anodized Aluminum (BAA), Stainless Steel (BSS)</p>	 <p><b>AF3AE</b></p>	<p><b>Trim Finish:</b> Black (BLK), Silver (SLV), White (WHT)</p>	 <p><b>AU2FE</b></p>	<p><b>Cover Code:</b> F-AL, F-S, F-B, F-W</p>
	<p><b>Option (Data &amp; Telecom):</b> A, B, C, D, E, F, G, H, J, K</p>		<p><b>Body Finish:</b> White (WHT), Gray (GRY), Black (BLK), Orange (ORN), Red (RED), Green (GRN), Blue (BLU)</p>		<p><b>Option (Data &amp; Telecom):</b> C, K</p>

# Wall-Mount Arc End Rectangular Nova Table

TNWAT

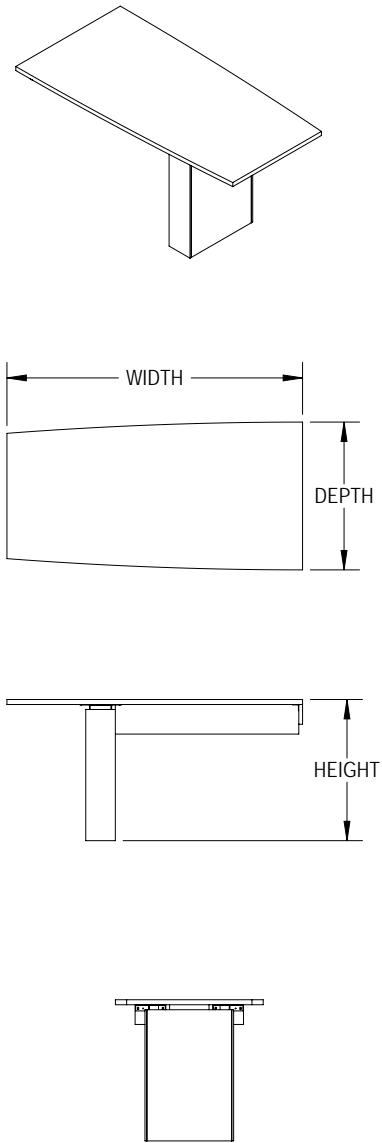

NOMINAL SIZE		TOP	POWER	LAMINATE		
WIDTH	DEPTH	SECTIONS	QUANTITY	PRICE M1	PRICE H1	PRICE K1
60"	30"	1	0	\$2,424	\$2,678	\$3,140
72"	30"	1	0	\$2,425	\$2,679	\$3,142
60"	36"	1	1	\$2,524	\$2,761	\$3,188
72"	36"	1	1	\$2,531	\$2,785	\$3,252
72"	42"	1	1	\$2,532	\$2,787	\$3,253
78"	42"	1	1	\$2,538	\$2,789	\$3,257
84"	42"	1	1	\$2,538	\$2,789	\$3,257
90"	42"	1	1	\$2,540	\$2,793	\$3,262
96"	42"	1	1	\$2,540	\$2,793	\$3,262
72"	48"	1	1	\$2,537	\$2,788	\$3,255
78"	48"	1	1	\$2,539	\$2,792	\$3,259
84"	48"	1	1	\$2,539	\$2,792	\$3,259
90"	48"	1	1	\$2,541	\$2,794	\$3,263
96"	48"	1	1	\$2,541	\$2,794	\$3,263
72"	54"	1	1	\$2,646	\$2,899	\$3,367
78"	54"	1	1	\$2,647	\$2,901	\$3,370
84"	54"	1	1	\$2,647	\$2,901	\$3,370
90"	54"	1	1	\$2,650	\$2,902	\$3,374
96"	54"	1	1	\$2,650	\$2,902	\$3,374
72"	60"	1	1	\$2,646	\$2,899	\$3,367
78"	60"	1	1	\$2,647	\$2,901	\$3,370
84"	60"	1	1	\$2,647	\$2,901	\$3,370
90"	60"	1	1	\$2,650	\$2,902	\$3,374
96"	60"	1	1	\$2,650	\$2,902	\$3,374

**ORDER CODE SAMPLE**

LINE 1	TABLE	ITEM CODE	WIDTH	DEPTH	LAMINATE	OPTION
		TNWAT	W96	D48	M1	CC
LINE 1.1	POWER & DATA	POWER OPTION	FINISH / TRIM FINISH / COVER CODE	BODY FINISH / OPTION	POWER QTY	
		AF2RE	SLV	D	1	

**Features & Specifications**

No Charge Options  
Optional Extra

- Laminate codes - M1: 1" LPL, H1: 1" HPL, K1: 1.25" knife edge (top only)
- Base laminate is 3/4" LPL
- Wire management in each leg
- Height is 29" nominal, including levellers, including levellers
- Available in all standard laminates
- For 3" curved corners add option code "CC" and \$349
- For 3" center grommet (AG30A) add option code "GC" and \$76

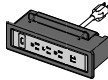
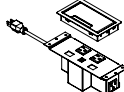
POWER & DATA	For detailed specification, cover code finishes, data and telecom options, and pricing of each electrical modules please refer to page "Power & Data Options".				
<b>AF2RE</b> 	<b>Finish:</b> Black (BLK), Silver (SLV), White (WHT), Anodized Aluminum (BAA), Stainless Steel (BSS)	<b>AF3AE</b> 	<b>Trim Finish:</b> Black (BLK), Silver (SLV), White (WHT)	<b>AU2FE</b> 	<b>Cover Code:</b> F-AL, F-S, F-B, F-W
	<b>Option (Data &amp; Telecom):</b> A, B, C, D, E, F, G, H, J, K		<b>Body Finish:</b> White (WHT), Gray (GRY), Black (BLK), Orange (ORN), Red (RED), Green (GRN), Blue (BLU)		<b>Option (Data &amp; Telecom):</b> C, K

PRODUCT MAP  
CONFERENCE TABLES  
MEDIA TABLES  
PARSONS TABLES  
MEETING & CASUAL TABLES  
NEST TRAINING TABLES  
www.brc.group

# Wall-Mount Bullet End Nova Table

TNWTT

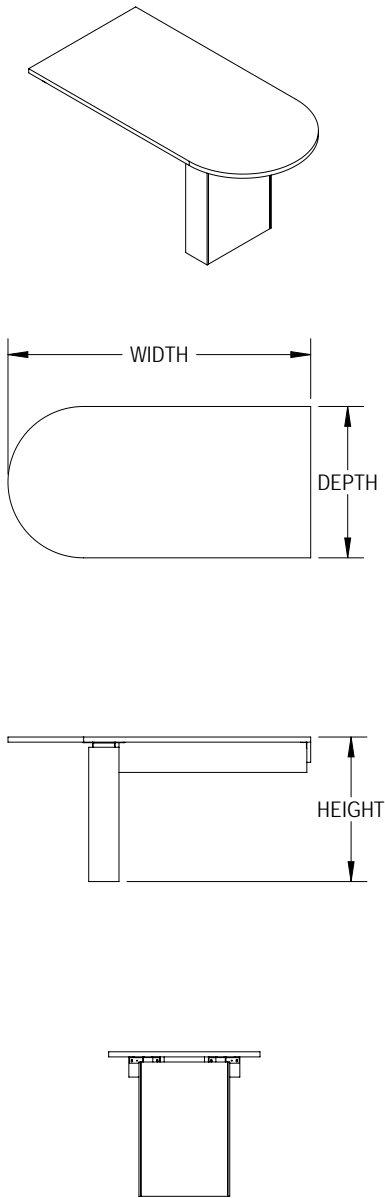

NOMINAL SIZE		TOP	POWER	LAMINATE		
WIDTH	DEPTH	SECTIONS	QUANTITY	PRICE M1	PRICE H1	PRICE K1
60"	30"	1	0	\$2,424	\$2,678	\$3,140
72"	30"	1	0	\$2,425	\$2,679	\$3,142
60"	36"	1	1	\$2,524	\$2,761	\$3,188
72"	36"	1	1	\$2,531	\$2,785	\$3,252
72"	42"	1	1	\$2,532	\$2,787	\$3,253
78"	42"	1	1	\$2,538	\$2,789	\$3,257
84"	42"	1	1	\$2,538	\$2,789	\$3,257
90"	42"	1	1	\$2,540	\$2,793	\$3,262
96"	42"	1	1	\$2,540	\$2,793	\$3,262
72"	48"	1	1	\$2,537	\$2,788	\$3,255
78"	48"	1	1	\$2,539	\$2,792	\$3,259
84"	48"	1	1	\$2,539	\$2,792	\$3,259
90"	48"	1	1	\$2,541	\$2,794	\$3,263
96"	48"	1	1	\$2,541	\$2,794	\$3,263
72"	54"	1	1	\$2,646	\$2,899	\$3,367
78"	54"	1	1	\$2,647	\$2,901	\$3,370
84"	54"	1	1	\$2,647	\$2,901	\$3,370
90"	54"	1	1	\$2,650	\$2,902	\$3,374
96"	54"	1	1	\$2,650	\$2,902	\$3,374
72"	60"	1	1	\$2,646	\$2,899	\$3,367
78"	60"	1	1	\$2,647	\$2,901	\$3,370
84"	60"	1	1	\$2,647	\$2,901	\$3,370
90"	60"	1	1	\$2,650	\$2,902	\$3,374
96"	60"	1	1	\$2,650	\$2,902	\$3,374

**ORDER CODE SAMPLE**

LINE 1	TABLE	ITEM CODE	WIDTH	DEPTH	LAMINATE
		TNWTT	W96	D48	M1
LINE 1.1	POWER & DATA	POWER OPTION	FINISH / TRIM FINISH / COVER CODE	BODY FINISH / OPTION	POWER QTY
		AF2RE	SLV	D	1

**Features & Specifications**

No Charge Options  
Optional Extra

- Laminate codes - M1: 1" LPL, H1: 1" HPL, K1: 1.25" knife edge (top only)
- Base laminate is 3/4" LPL
- Wire management in each leg
- Height is 29" nominal, including levellers, including levellers
- Available in all standard laminates
- For 3" center grommet (AG30A) add option code "GC" and \$76

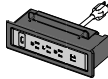
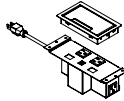
POWER & DATA	For detailed specification, cover code finishes, data and telecom options, and pricing of each electrical modules please refer to page "Power & Data Options".				
<b>AF2RE</b> 	<b>Finish:</b> Black (BLK), Silver (SLV), White (WHT), Anodized Aluminum (BAA), Stainless Steel (BSS)	<b>AF3AE</b> 	<b>Trim Finish:</b> Black (BLK), Silver (SLV), White (WHT)	<b>AU2FE</b> 	<b>Cover Code:</b> F-AL, F-S, F-B, F-W
	<b>Option (Data &amp; Telecom):</b> A, B, C, D, E, F, G, H, J, K		<b>Body Finish:</b> White (WHT), Gray (GRY), Black (BLK), Orange (ORN), Red (RED), Green (GRN), Blue (BLU)		<b>Option (Data &amp; Telecom):</b> C, K

# Wall-Mount Arced Boat Nova Table

TNWBT

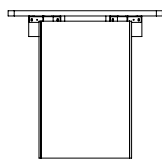
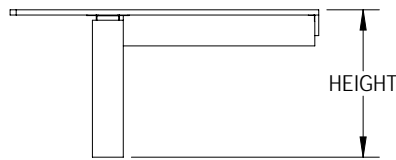
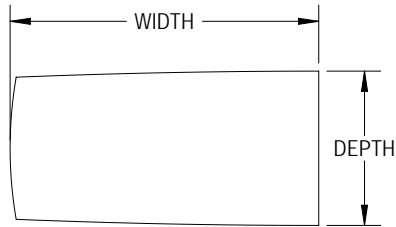
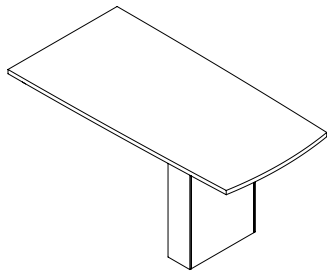

NOMINAL SIZE		TOP	POWER	LAMINATE		
WIDTH	DEPTH	SECTIONS	QUANTITY	PRICE M1	PRICE H1	PRICE K1
60"	30"	1	0	\$2,424	\$2,678	\$3,140
72"	30"	1	0	\$2,425	\$2,679	\$3,142
60"	36"	1	1	\$2,524	\$2,761	\$3,188
72"	36"	1	1	\$2,531	\$2,785	\$3,252
72"	42"	1	1	\$2,532	\$2,787	\$3,253
78"	42"	1	1	\$2,538	\$2,789	\$3,257
84"	42"	1	1	\$2,538	\$2,789	\$3,257
90"	42"	1	1	\$2,540	\$2,793	\$3,262
96"	42"	1	1	\$2,540	\$2,793	\$3,262
72"	48"	1	1	\$2,537	\$2,788	\$3,255
78"	48"	1	1	\$2,539	\$2,792	\$3,259
84"	48"	1	1	\$2,539	\$2,792	\$3,259
90"	48"	1	1	\$2,541	\$2,794	\$3,263
96"	48"	1	1	\$2,541	\$2,794	\$3,263
72"	54"	1	1	\$2,646	\$2,899	\$3,367
78"	54"	1	1	\$2,647	\$2,901	\$3,370
84"	54"	1	1	\$2,647	\$2,901	\$3,370
90"	54"	1	1	\$2,650	\$2,902	\$3,374
96"	54"	1	1	\$2,650	\$2,902	\$3,374
72"	60"	1	1	\$2,646	\$2,899	\$3,367
78"	60"	1	1	\$2,647	\$2,901	\$3,370
84"	60"	1	1	\$2,647	\$2,901	\$3,370
90"	60"	1	1	\$2,650	\$2,902	\$3,374
96"	60"	1	1	\$2,650	\$2,902	\$3,374

**ORDER CODE SAMPLE**

LINE 1	TABLE	ITEM CODE	WIDTH	DEPTH	LAMINATE	OPTION
		TNWBT	W96	D48	M1	CC
LINE 1.1	POWER & DATA	POWER OPTION	FINISH / TRIM FINISH / COVER CODE	BODY FINISH / OPTION	POWER QTY	
		AF2RE	SLV	D	1	

**Features & Specifications**

No Charge Options  
Optional Extra

- Laminate codes - M1: 1" LPL, H1: 1" HPL, K1: 1.25" knife edge (top only)
- Base laminate is 3/4" LPL
- Wire management in each leg
- Height is 29" nominal, including levellers
- Available in all standard laminates
- For 3" curved corners add option code "CC" and \$349
- For 3" center grommet (AG30A) add option code "GC" and \$76

**POWER & DATA** For detailed specification, cover code finishes, data and telecom options, and pricing of each electrical modules please refer to page "Power & Data Options".

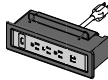
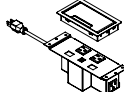
 <p><b>AF2RE</b></p>	<p><b>Finish:</b> Black (BLK), Silver (SLV), White (WHT), Anodized Aluminum (BAA), Stainless Steel (BSS)</p>	 <p><b>AF3AE</b></p>	<p><b>Trim Finish:</b> Black (BLK), Silver (SLV), White (WHT)</p>	 <p><b>AU2FE</b></p>	<p><b>Cover Code:</b> F-AL, F-S, F-B, F-W</p>
	<p><b>Option (Data &amp; Telecom):</b> A, B, C, D, E, F, G, H, J, K</p>		<p><b>Body Finish:</b> White (WHT), Gray (GRY), Black (BLK), Orange (ORN), Red (RED), Green (GRN), Blue (BLU)</p>		<p><b>Option (Data &amp; Telecom):</b> C, K</p>

PRODUCT MAP  
CONFERENCE TABLES  
MEDIA TABLES  
PARSONS TABLES  
MEETING & CASUAL TABLES  
NEST TRAINING TABLES  
www.brc.group

# Wall-Mount Trapezoid Nova Table

TNWZT

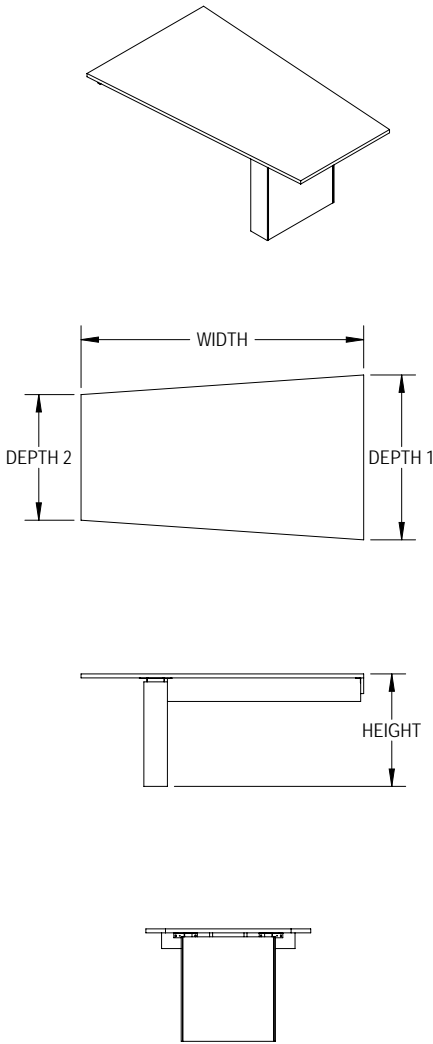

NOMINAL SIZE			TOP	POWER	LAMINATE		
WIDTH	DEPTH 1	DEPTH 2	SECTIONS	QUANTITY	PRICE M1	PRICE H1	PRICE K1
72"	42"	32"	1	1	\$2,532	\$2,787	\$3,253
78"	42"	32"	1	1	\$2,538	\$2,789	\$3,257
84"	42"	32"	1	1	\$2,538	\$2,789	\$3,257
90"	42"	32"	1	1	\$2,540	\$2,793	\$3,262
96"	42"	32"	1	1	\$2,540	\$2,793	\$3,262
72"	48"	38"	1	1	\$2,537	\$2,788	\$3,255
78"	48"	38"	1	1	\$2,539	\$2,792	\$3,259
84"	48"	38"	1	1	\$2,539	\$2,792	\$3,259
90"	48"	38"	1	1	\$2,541	\$2,794	\$3,263
96"	48"	38"	1	1	\$2,541	\$2,794	\$3,263
72"	54"	44"	1	1	\$2,646	\$2,899	\$3,367
78"	54"	44"	1	1	\$2,647	\$2,901	\$3,370
84"	54"	44"	1	1	\$2,647	\$2,901	\$3,370
90"	54"	44"	1	1	\$2,650	\$2,902	\$3,374
96"	54"	44"	1	1	\$2,650	\$2,902	\$3,374
72"	60"	50"	1	1	\$2,646	\$2,899	\$3,367
78"	60"	50"	1	1	\$2,647	\$2,901	\$3,370
84"	60"	50"	1	1	\$2,647	\$2,901	\$3,370
90"	60"	50"	1	1	\$2,650	\$2,902	\$3,374
96"	60"	50"	1	1	\$2,650	\$2,902	\$3,374

**ORDER CODE SAMPLE**

LINE 1	TABLE	ITEM CODE	WIDTH	DEPTH 1	DEPTH 2	LAMINATE	OPTION
		TNWZT	W96	D48	D38	M1	CC
LINE 1.1	POWER & DATA	POWER OPTION	FINISH / TRIM FINISH / COVER CODE	BODY FINISH / OPTION		POWER QTY	
		AF2RE	SLV	D		1	

**Features & Specifications**

No Charge Options  
Optional Extra

- Laminate codes - M1: 1" LPL, H1: 1" HPL, K1: 1.25" knife edge (top only)
- Base laminate is 3/4" LPL
- Wire management in each leg
- Height is 29" nominal, including levellers
- Available in all standard laminates
- For 3" curved corners add option code "CC" and \$349
- For 3" center grommet (AG30A) add option code "GC" and \$76

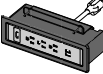
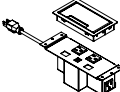
POWER & DATA	For detailed specification, cover code finishes, data and telecom options, and pricing of each electrical modules please refer to page "Power & Data Options".				
<b>AF2RE</b> 	<b>Finish:</b> Black (BLK), Silver (SLV), White (WHT), Anodized Aluminum (BAA), Stainless Steel (BSS)	<b>AF3AE</b> 	<b>Trim Finish:</b> Black (BLK), Silver (SLV), White (WHT)	<b>AU2FE</b> 	<b>Cover Code:</b> F-AL, F-S, F-B, F-W
	<b>Option (Data &amp; Telecom):</b> A, B, C, D, E, F, G, H, J, K		<b>Body Finish:</b> White (WHT), Gray (GRY), Black (BLK), Orange (ORN), Red (RED), Green (GRN), Blue (BLU)		<b>Option (Data &amp; Telecom):</b> C, K

PRODUCT MAP  
CONFERENCE TABLES  
MEDIA TABLES  
PARSONS TABLES  
MEETING & CASUAL TABLES  
NEST TRAINING TABLES  
www.brc.group

# Wall-Mount Rectangular Nova Table - Tri-Base

TNRWT

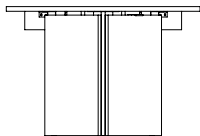
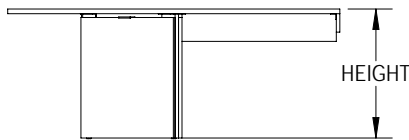
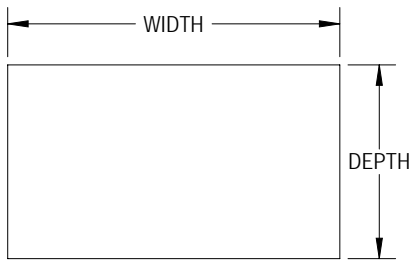
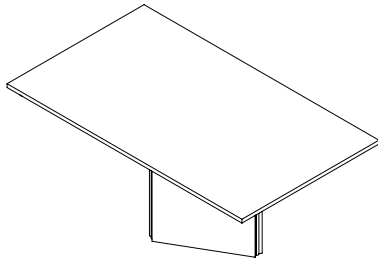

NOMINAL SIZE		TOP	POWER	LAMINATE		
WIDTH	DEPTH	SECTIONS	QUANTITY	PRICE M1	PRICE H1	PRICE K1
72"	42"	1	1	3,486	3,781	4,357
78"	42"	1	1	3,493	3,791	4,362
84"	42"	1	1	3,493	3,791	4,362
90"	42"	1	1	3,499	3,799	4,367
96"	42"	1	1	3,499	3,799	4,367
72"	48"	1	1	3,486	3,781	4,359
78"	48"	1	1	3,493	3,791	4,365
84"	48"	1	1	3,493	3,791	4,365
90"	48"	1	1	3,499	3,799	4,369
96"	48"	1	1	3,499	3,799	4,369
72"	54"	1	1	3,628	3,923	4,507
78"	54"	1	1	3,636	3,933	4,512
84"	54"	1	1	3,636	3,933	4,512
90"	54"	1	1	3,641	3,941	4,516
96"	54"	1	1	3,641	3,941	4,516
72"	60"	1	1	3,628	3,923	4,507
78"	60"	1	1	3,636	3,933	4,512
84"	60"	1	1	3,636	3,933	4,512
90"	60"	1	1	3,641	3,941	4,516
96"	60"	1	1	3,641	3,941	4,516

**ORDER CODE SAMPLE**

LINE 1	TABLE	ITEM CODE	WIDTH	DEPTH	LAMINATE	OPTION
		TNRWT	W96	D48	M1	CC
LINE 1.1	POWER & DATA	POWER OPTION	FINISH / TRIM FINISH / COVER CODE	BODY FINISH / OPTION	POWER QTY	
		AF2RE	SLV	D	1	

**Features & Specifications**

No Charge Options  
Optional Extra

- Laminate codes - M1: 1" LPL, H1: 1" HPL, K1: 1.25" knife edge (top only)
- Base laminate is 3/4" LPL
- Wire management in each leg
- Height is 29" nominal, including levellers
- Available in all standard laminates
- For 3" curved corners add option code "CC" and \$349
- For 3" center grommet (AG30A) add option code "GC" and \$76

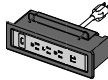
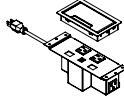
POWER & DATA	For detailed specification, cover code finishes, data and telecom options, and pricing of each electrical modules please refer to page "Power & Data Options".				
<b>AF2RE</b> 	<b>Finish:</b> Black (BLK), Silver (SLV), White (WHT), Anodized Aluminum (BAA), Stainless Steel (BSS)	<b>AF3AE</b> 	<b>Trim Finish:</b> Black (BLK), Silver (SLV), White (WHT)	<b>AU2FE</b> 	<b>Cover Code:</b> F-AL, F-S, F-B, F-W
	<b>Option (Data &amp; Telecom):</b> A, B, C, D, E, F, G, H, J, K		<b>Body Finish:</b> White (WHT), Gray (GRY), Black (BLK), Orange (ORN), Red (RED), Green (GRN), Blue (BLU)		<b>Option (Data &amp; Telecom):</b> C, K

# Wall-Mount Arc End Nova Table - Tri-Base

TNAWT

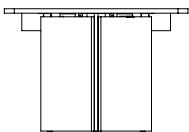
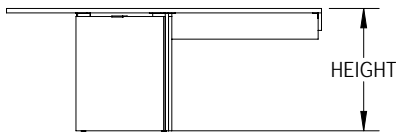
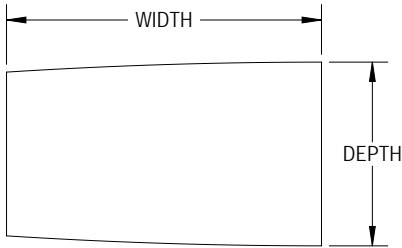
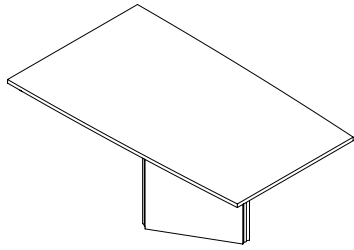

NOMINAL SIZE		TOP	POWER	LAMINATE		
WIDTH	DEPTH	SECTIONS	QUANTITY	PRICE M1	PRICE H1	PRICE K1
72"	42"	1	1	3,561	3,899	4,520
78"	42"	1	1	3,565	3,902	4,525
84"	42"	1	1	3,565	3,902	4,525
90"	42"	1	1	3,568	3,907	4,532
96"	42"	1	1	3,568	3,907	4,532
72"	48"	1	1	3,564	3,901	4,523
78"	48"	1	1	3,566	3,905	4,528
84"	48"	1	1	3,566	3,905	4,528
90"	48"	1	1	3,569	3,908	4,534
96"	48"	1	1	3,569	3,908	4,534
72"	54"	1	1	3,708	4,046	4,670
78"	54"	1	1	3,712	4,050	4,676
84"	54"	1	1	3,712	4,050	4,676
90"	54"	1	1	3,716	4,053	4,681
96"	54"	1	1	3,716	4,053	4,681
72"	60"	1	1	3,708	4,046	4,670
78"	60"	1	1	3,712	4,050	4,676
84"	60"	1	1	3,712	4,050	4,676
90"	60"	1	1	3,716	4,053	4,681
96"	60"	1	1	3,716	4,053	4,681

**ORDER CODE SAMPLE**

LINE 1	TABLE	ITEM CODE	WIDTH	DEPTH	LAMINATE	OPTION
		TNAWT	W96	D48	M1	CC
LINE 1.1	POWER & DATA	POWER OPTION	FINISH / TRIM FINISH / COVER CODE	BODY FINISH / OPTION	POWER QTY	
		AF2RE	SLV	D	1	

**Features & Specifications**

No Charge Options  
Optional Extra

- Laminate codes - M1: 1" LPL, H1: 1" HPL, K1: 1.25" knife edge (top only)
- Base laminate is 3/4" LPL
- Wire management in each leg
- Height is 29" nominal, including levellers
- Available in all standard laminates
- For 3" curved corners add option code "CC" and \$349
- For 3" center grommet (AG30A) add option code "GC" and \$76

**POWER & DATA** For detailed specification, cover code finishes, data and telecom options, and pricing of each electrical modules please refer to page "Power & Data Options".

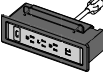
 <p><b>AF2RE</b></p>	<p><b>Finish:</b> Black (BLK), Silver (SLV), White (WHT), Anodized Aluminum (BAA), Stainless Steel (BSS)</p>	 <p><b>AF3AE</b></p>	<p><b>Trim Finish:</b> Black (BLK), Silver (SLV), White (WHT)</p>	 <p><b>AU2FE</b></p>	<p><b>Cover Code:</b> F-AL, F-S, F-B, F-W</p>
	<p><b>Option (Data &amp; Telecom):</b> A, B, C, D, E, F, G, H, J, K</p>		<p><b>Body Finish:</b> White (WHT), Gray (GRY), Black (BLK), Orange (ORN), Red (RED), Green (GRN), Blue (BLU)</p>		<p><b>Option (Data &amp; Telecom):</b> C, K</p>

# Wall-Mount Bullet End Nova Table - Tri-Base

TNTWT

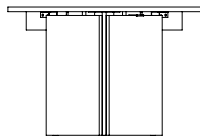
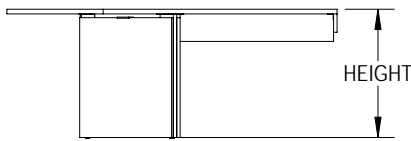
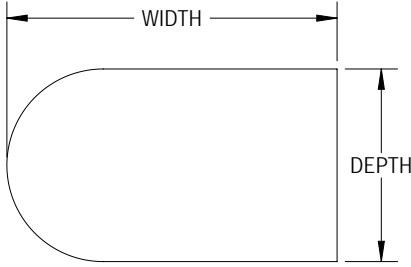
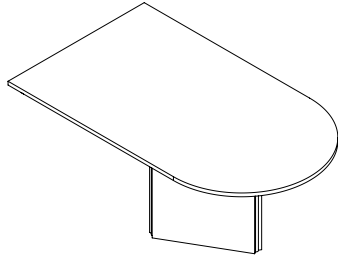

NOMINAL SIZE		TOP	POWER	LAMINATE		
WIDTH	DEPTH	SECTIONS	QUANTITY	PRICE M1	PRICE H1	PRICE K1
72"	42"	1	1	3,561	3,899	4,520
78"	42"	1	1	3,565	3,902	4,525
84"	42"	1	1	3,565	3,902	4,525
90"	42"	1	1	3,568	3,907	4,532
96"	42"	1	1	3,568	3,907	4,532
72"	48"	1	1	3,564	3,901	4,523
78"	48"	1	1	3,566	3,905	4,528
84"	48"	1	1	3,566	3,905	4,528
90"	48"	1	1	3,569	3,908	4,534
96"	48"	1	1	3,569	3,908	4,534
72"	54"	1	1	3,708	4,046	4,670
78"	54"	1	1	3,712	4,050	4,676
84"	54"	1	1	3,712	4,050	4,676
90"	54"	1	1	3,716	4,053	4,681
96"	54"	1	1	3,716	4,053	4,681
72"	60"	1	1	3,708	4,046	4,670
78"	60"	1	1	3,712	4,050	4,676
84"	60"	1	1	3,712	4,050	4,676
90"	60"	1	1	3,716	4,053	4,681
96"	60"	1	1	3,716	4,053	4,681

**ORDER CODE SAMPLE**

LINE 1	TABLE	ITEM CODE	WIDTH	DEPTH	LAMINATE
		TNTWT	W96	D48	M1
LINE 1.1	POWER & DATA	POWER OPTION	FINISH / TRIM FINISH / COVER CODE	BODY FINISH / OPTION	POWER QTY
		AF2RE	SLV	D	1

**Features & Specifications**

No Charge Options  
Optional Extra

- Laminate codes - M1: 1" LPL, H1: 1" HPL, K1: 1.25" knife edge (top only)
- Base laminate is 3/4" LPL
- Wire management in each leg
- Height is 29" nominal, including levelers
- Available in all standard laminates
- For 3" center grommet (AG30A) add option code "GC" and \$76

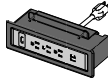
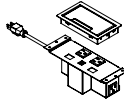
POWER & DATA	For detailed specification, cover code finishes, data and telecom options, and pricing of each electrical modules please refer to page "Power & Data Options".				
<b>AF2RE</b> 	<b>Finish:</b> Black (BLK), Silver (SLV), White (WHT), Anodized Aluminum (BAA), Stainless Steel (BSS)	<b>AF3AE</b> 	<b>Trim Finish:</b> Black (BLK), Silver (SLV), White (WHT)	<b>AU2FE</b> 	<b>Cover Code:</b> F-AL, F-S, F-B, F-W
	<b>Option (Data &amp; Telecom):</b> A, B, C, D, E, F, G, H, J, K		<b>Body Finish:</b> White (WHT), Gray (GRY), Black (BLK), Orange (ORN), Red (RED), Green (GRN), Blue (BLU)		<b>Option (Data &amp; Telecom):</b> C, K

# Wall-Mount Arced Boat Nova Table - Tri-Base

TNBWT

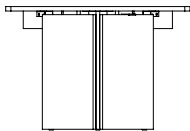
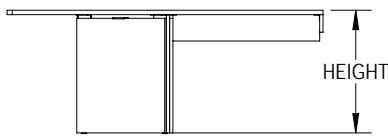
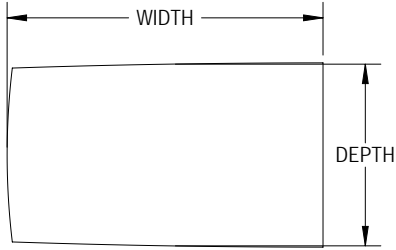
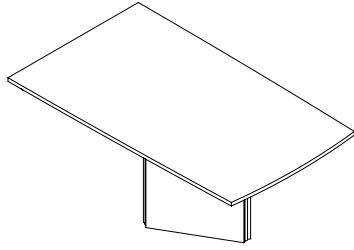

NOMINAL SIZE		TOP	POWER	LAMINATE		
WIDTH	DEPTH	SECTIONS	QUANTITY	PRICE M1	PRICE H1	PRICE K1
72"	42"	1	1	3,561	3,899	4,520
78"	42"	1	1	3,565	3,902	4,525
84"	42"	1	1	3,565	3,902	4,525
90"	42"	1	1	3,568	3,907	4,532
96"	42"	1	1	3,568	3,907	4,532
72"	48"	1	1	3,564	3,901	4,523
78"	48"	1	1	3,566	3,905	4,528
84"	48"	1	1	3,566	3,905	4,528
90"	48"	1	1	3,569	3,908	4,534
96"	48"	1	1	3,569	3,908	4,534
72"	54"	1	1	3,708	4,046	4,670
78"	54"	1	1	3,712	4,050	4,676
84"	54"	1	1	3,712	4,050	4,676
90"	54"	1	1	3,716	4,053	4,681
96"	54"	1	1	3,716	4,053	4,681
72"	60"	1	1	3,708	4,046	4,670
78"	60"	1	1	3,712	4,050	4,676
84"	60"	1	1	3,712	4,050	4,676
90"	60"	1	1	3,716	4,053	4,681
96"	60"	1	1	3,716	4,053	4,681

**ORDER CODE SAMPLE**

LINE 1	TABLE	ITEM CODE	WIDTH	DEPTH	LAMINATE	OPTION
		TNBWT	W96	D48	M1	CC
LINE 1.1	POWER & DATA	POWER OPTION	FINISH / TRIM FINISH / COVER CODE	BODY FINISH / OPTION	POWER QTY	
		AF2RE	SLV	D	1	

**Features & Specifications**

No Charge Options  
Optional Extra

- Laminate codes - M1: 1" LPL, H1: 1" HPL, K1: 1.25" knife edge (top only)
- Base laminate is 3/4" LPL
- Wire management in each leg
- Height is 29" nominal, including levellers
- Available in all standard laminates
- For 3" curved corners add option code "CC" and \$349
- For 3" center grommet (AG30A) add option code "GC" and \$76

**POWER & DATA** For detailed specification, cover code finishes, data and telecom options, and pricing of each electrical modules please refer to page "Power & Data Options".

 <p><b>AF2RE</b></p>	<p><b>Finish:</b> Black (BLK), Silver (SLV), White (WHT), Anodized Aluminum (BAA), Stainless Steel (BSS)</p>	 <p><b>AF3AE</b></p>	<p><b>Trim Finish:</b> Black (BLK), Silver (SLV), White (WHT)</p>	 <p><b>AU2FE</b></p>	<p><b>Cover Code:</b> F-AL, F-S, F-B, F-W</p>
	<p><b>Option (Data &amp; Telecom):</b> A, B, C, D, E, F, G, H, J, K</p>		<p><b>Body Finish:</b> White (WHT), Gray (GRY), Black (BLK), Orange (ORN), Red (RED), Green (GRN), Blue (BLU)</p>		<p><b>Option (Data &amp; Telecom):</b> C, K</p>

# Wall-Mount Trapezoid Nova Table - Tri-Base

TNZWT

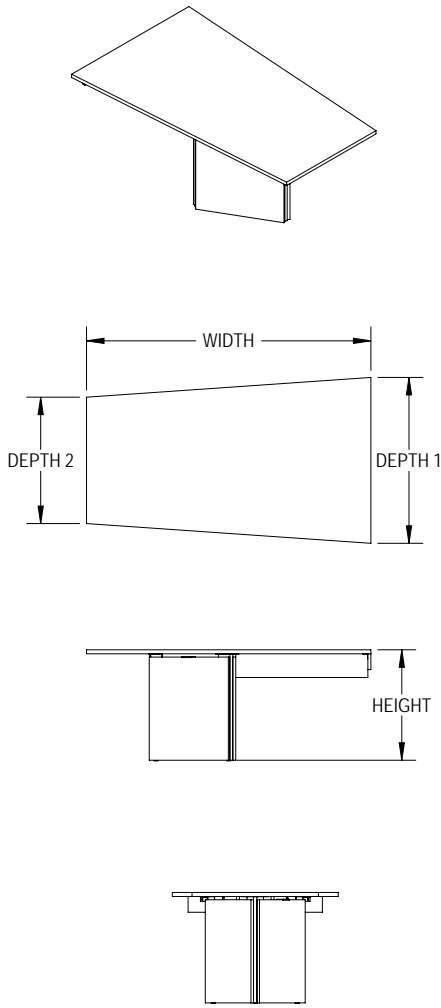

NOMINAL SIZE			TOP	POWER	LAMINATE		
WIDTH	DEPTH 1	DEPTH 2	SECTIONS	QUANTITY	PRICE M1	PRICE H1	PRICE K1
72"	42"	32"	1	1	3,561	3,899	4,520
78"	42"	32"	1	1	3,565	3,902	4,525
84"	42"	32"	1	1	3,565	3,902	4,525
90"	42"	32"	1	1	3,568	3,907	4,532
96"	42"	32"	1	1	3,568	3,907	4,532
72"	48"	38"	1	1	3,564	3,901	4,523
78"	48"	38"	1	1	3,566	3,905	4,528
84"	48"	38"	1	1	3,566	3,905	4,528
90"	48"	38"	1	1	3,569	3,908	4,534
96"	48"	38"	1	1	3,569	3,908	4,534
72"	54"	44"	1	1	3,708	4,046	4,670
78"	54"	44"	1	1	3,712	4,050	4,676
84"	54"	44"	1	1	3,712	4,050	4,676
90"	54"	44"	1	1	3,716	4,053	4,681
96"	54"	44"	1	1	3,716	4,053	4,681
72"	60"	50"	1	1	3,708	4,046	4,670
78"	60"	50"	1	1	3,712	4,050	4,676
84"	60"	50"	1	1	3,712	4,050	4,676
90"	60"	50"	1	1	3,716	4,053	4,681
96"	60"	50"	1	1	3,716	4,053	4,681

**ORDER CODE SAMPLE**

LINE 1	TABLE	ITEM CODE	WIDTH	DEPTH 1	DEPTH 2	LAMINATE	OPTION
		TNZWT	W96	D48	D38	M1	CC
LINE 1.1	POWER & DATA	POWER OPTION	FINISH / TRIM FINISH / COVER CODE	BODY FINISH / OPTION	POWER QTY		
		AF2RE	SLV	D	1		

**Features & Specifications**

No Charge Options  
Optional Extra

- Laminate codes - M1: 1" LPL, H1: 1" HPL, K1: 1.25" knife edge (top only)
- Base laminate is 3/4" LPL
- Wire management in each leg
- Height is 29" nominal, including levelers
- Available in all standard laminates
- For 3" curved corners add option code "CC" and \$349
- For 3" center grommet (AG30A) add option code "GC" and \$76

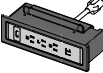
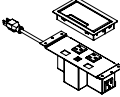
POWER & DATA	For detailed specification, cover code finishes, data and telecom options, and pricing of each electrical modules please refer to page "Power & Data Options".				
<b>AF2RE</b> 	<b>Finish:</b> Black (BLK), Silver (SLV), White (WHT), Anodized Aluminum (BAA), Stainless Steel (BSS)	<b>AF3AE</b> 	<b>Trim Finish:</b> Black (BLK), Silver (SLV), White (WHT)	<b>AU2FE</b> 	<b>Cover Code:</b> F-AL, F-S, F-B, F-W
	<b>Option (Data &amp; Telecom):</b> A, B, C, D, E, F, G, H, J, K		<b>Body Finish:</b> White (WHT), Gray (GRY), Black (BLK), Orange (ORN), Red (RED), Green (GRN), Blue (BLU)		<b>Option (Data &amp; Telecom):</b> C, K

PRODUCT MAP  
CONFERENCE TABLES  
MEDIA TABLES  
PARSONS TABLES  
MEETING & CASUAL TABLES  
NEST TRAINING TABLES  
www.brc.group

# Wall-Mount Rectangle Disc Base Table

TDRWT

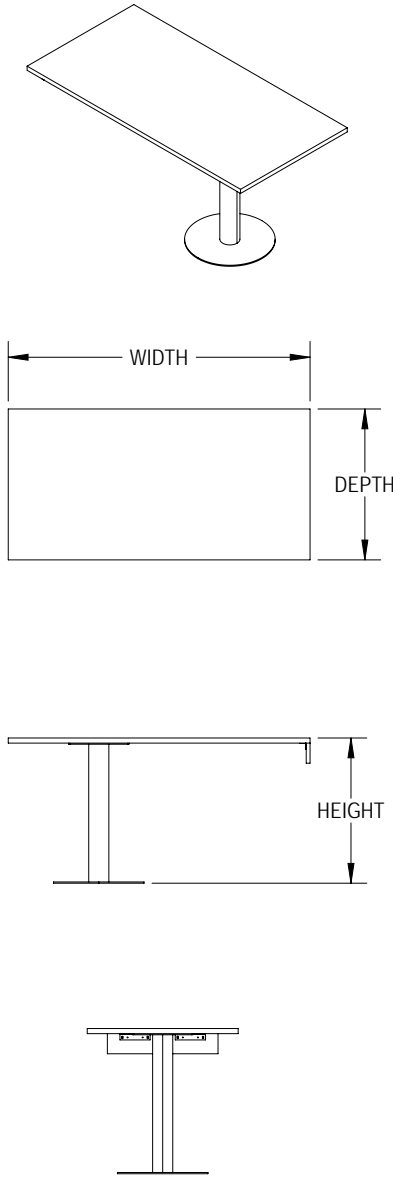

NOMINAL SIZE		POWER	LAMINATE		
WIDTH	DEPTH	QUANTITY	PRICE M1	PRICE H1	PRICE K1
60"	30"	0	\$3,194	\$3,475	\$4,099
72"	30"	0	\$3,208	\$3,491	\$4,101
60"	36"	1	\$3,220	\$3,511	\$4,026
72"	36"	1	\$3,235	\$3,529	\$4,103
72"	42"	1	\$3,646	\$3,943	\$4,516
78"	42"	1	\$3,652	\$3,951	\$4,523
84"	42"	1	\$3,652	\$3,951	\$4,523
90"	42"	1	\$3,659	\$3,961	\$4,528
96"	42"	1	\$3,659	\$3,961	\$4,528
72"	48"	1	\$3,646	\$3,943	\$4,520
78"	48"	1	\$3,652	\$3,951	\$4,525
84"	48"	1	\$3,652	\$3,951	\$4,525
90"	48"	1	\$3,659	\$3,961	\$4,529
96"	48"	1	\$3,659	\$3,961	\$4,529
72"	54"	1	\$4,276	\$4,570	\$5,153
78"	54"	1	\$4,283	\$4,580	\$5,159
84"	54"	1	\$4,283	\$4,580	\$5,159
90"	54"	1	\$4,290	\$4,589	\$5,165
96"	54"	1	\$4,290	\$4,589	\$5,165
72"	60"	1	\$5,578	\$5,875	\$6,457
78"	60"	1	\$5,585	\$5,884	\$6,461
84"	60"	1	\$5,585	\$5,884	\$6,461
90"	60"	1	\$5,592	\$5,892	\$6,467
96"	60"	1	\$5,592	\$5,892	\$6,467

**ORDER CODE SAMPLE**

LINE 1	TABLE	ITEM CODE	WIDTH	DEPTH	LAMINATE	OPTION
		TDRWT	W96	D48	M1	CC
LINE 1.1	POWER & DATA	POWER OPTION	FINISH / TRIM FINISH / COVER CODE	BODY FINISH / OPTION	POWER QTY	
		AF2RE	SLV	D	1	

**Features & Specifications**

No Charge Options  
Optional Extra

- Laminate codes - M1: 1" LPL, H1: 1" HPL, K1: 1.25" knife edge (top only)
- Metal base construction
- Height is 29" nominal, including levellers
- Available in all standard laminates
- For 3" curved corners add option code "CC" and \$349
- For wire management please refer to BRC's accessories price guide
- For 3" center grommet (AG30A) add option code "GC" and \$76

**POWER & DATA** For detailed specification, cover code finishes, data and telecom options, and pricing of each electrical modules please refer to page "Power & Data Options".

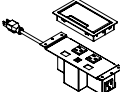
 <p><b>AF2RE</b></p>	<p><b>Finish:</b> Black (BLK), Silver (SLV), White (WHT), Anodized Aluminum (BAA), Stainless Steel (BSS)</p>	 <p><b>AF3AE</b></p>	<p><b>Trim Finish:</b> Black (BLK), Silver (SLV), White (WHT)</p>	 <p><b>AU2FE</b></p>	<p><b>Cover Code:</b> F-AL, F-S, F-B, F-W</p>
	<p><b>Option (Data &amp; Telecom):</b> A, B, C, D, E, F, G, H, J, K</p>		<p><b>Body Finish:</b> White (WHT), Gray (GRY), Black (BLK), Orange (ORN), Red (RED), Green (GRN), Blue (BLU)</p>		<p><b>Option (Data &amp; Telecom):</b> C, K</p>

# Wall-Mount Arced Disc Base Table

TDAWT

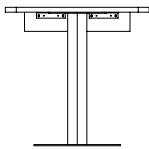
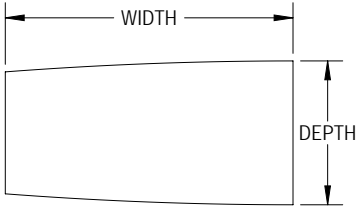
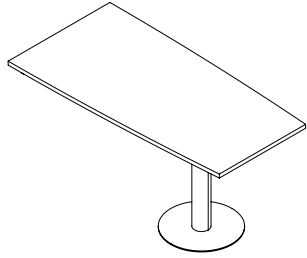

NOMINAL SIZE		POWER	LAMINATE		
WIDTH	DEPTH	QUANTITY	PRICE M1	PRICE H1	PRICE K1
60"	30"	0	\$3,306	\$3,644	\$4,260
72"	30"	0	\$3,307	\$3,645	\$4,263
60"	36"	1	\$3,295	\$3,615	\$4,182
72"	36"	1	\$3,308	\$3,646	\$4,265
72"	42"	1	\$3,722	\$4,060	\$4,681
78"	42"	1	\$3,726	\$4,063	\$4,687
84"	42"	1	\$3,726	\$4,063	\$4,687
90"	42"	1	\$3,729	\$4,068	\$4,691
96"	42"	1	\$3,729	\$4,068	\$4,691
72"	48"	1	\$3,723	\$4,061	\$4,685
78"	48"	1	\$3,727	\$4,065	\$4,689
84"	48"	1	\$3,727	\$4,065	\$4,689
90"	48"	1	\$3,730	\$4,069	\$4,694
96"	48"	1	\$3,730	\$4,069	\$4,694
72"	54"	1	\$4,356	\$4,694	\$5,316
78"	54"	1	\$4,359	\$4,698	\$5,324
84"	54"	1	\$4,359	\$4,698	\$5,324
90"	54"	1	\$4,363	\$4,700	\$5,330
96"	54"	1	\$4,363	\$4,700	\$5,330
72"	60"	1	\$5,659	\$5,998	\$6,622
78"	60"	1	\$5,663	\$6,000	\$6,626
84"	60"	1	\$5,663	\$6,000	\$6,626
90"	60"	1	\$5,665	\$6,004	\$6,632
96"	60"	1	\$5,665	\$6,004	\$6,632

**ORDER CODE SAMPLE**

LINE 1	TABLE	ITEM CODE	WIDTH	DEPTH	LAMINATE	OPTION
		TDAWT	W96	D48	M1	CC
LINE 1.1	POWER & DATA	POWER OPTION	FINISH / TRIM FINISH / COVER CODE	BODY FINISH / OPTION	POWER QTY	
		AF2RE	SLV	D	1	

**Features & Specifications**

No Charge Options  
Optional Extra

- Laminate codes - M1: 1" LPL, H1: 1" HPL, K1: 1.25" knife edge (top only)
- Metal base construction
- Height is 29" nominal, including levellers
- Available in all standard laminates
- For 3" curved corners add option code "CC" and \$349
- For wire management please refer to BRC's accessories price guide
- For 3" center grommet (AG30A) add option code "GC" and \$76

**POWER & DATA** For detailed specification, cover code finishes, data and telecom options, and pricing of each electrical modules please refer to page "Power & Data Options".

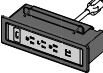
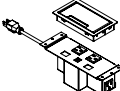
 <p><b>AF2RE</b></p>	<p><b>Finish:</b> Black (BLK), Silver (SLV), White (WHT), Anodized Aluminum (BAA), Stainless Steel (BSS)</p>	 <p><b>AF3AE</b></p>	<p><b>Trim Finish:</b> Black (BLK), Silver (SLV), White (WHT)</p>	 <p><b>AU2FE</b></p>	<p><b>Cover Code:</b> F-AL, F-S, F-B, F-W</p>
	<p><b>Option (Data &amp; Telecom):</b> A, B, C, D, E, F, G, H, J, K</p>		<p><b>Body Finish:</b> White (WHT), Gray (GRY), Black (BLK), Orange (ORN), Red (RED), Green (GRN), Blue (BLU)</p>		<p><b>Option (Data &amp; Telecom):</b> C, K</p>

# Wall-Mount Bullet End Disc Base Table

TDEWT

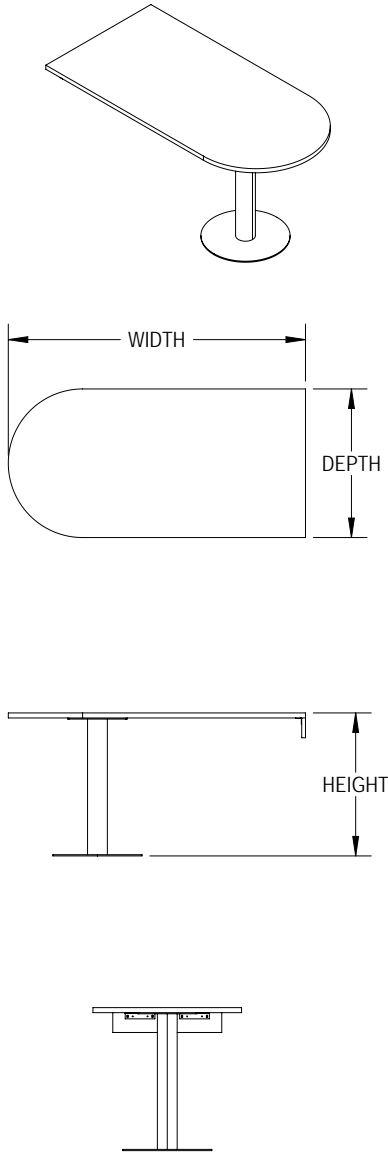

NOMINAL SIZE		POWER	LAMINATE		
WIDTH	DEPTH	QUANTITY	PRICE M1	PRICE H1	PRICE K1
60"	30"	0	\$3,306	\$3,644	\$4,260
72"	30"	0	\$3,307	\$3,645	\$4,263
60"	36"	1	\$3,295	\$3,615	\$4,182
72"	36"	1	\$3,308	\$3,646	\$4,265
72"	42"	1	\$3,722	\$4,060	\$4,681
78"	42"	1	\$3,726	\$4,063	\$4,687
84"	42"	1	\$3,726	\$4,063	\$4,687
90"	42"	1	\$3,729	\$4,068	\$4,691
96"	42"	1	\$3,729	\$4,068	\$4,691
72"	48"	1	\$3,723	\$4,061	\$4,685
78"	48"	1	\$3,727	\$4,065	\$4,689
84"	48"	1	\$3,727	\$4,065	\$4,689
90"	48"	1	\$3,730	\$4,069	\$4,694
96"	48"	1	\$3,730	\$4,069	\$4,694
72"	54"	1	\$4,356	\$4,694	\$5,316
78"	54"	1	\$4,359	\$4,698	\$5,324
84"	54"	1	\$4,359	\$4,698	\$5,324
90"	54"	1	\$4,363	\$4,700	\$5,330
96"	54"	1	\$4,363	\$4,700	\$5,330
72"	60"	1	\$5,659	\$5,998	\$6,622
78"	60"	1	\$5,663	\$6,000	\$6,626
84"	60"	1	\$5,663	\$6,000	\$6,626
90"	60"	1	\$5,665	\$6,004	\$6,632
96"	60"	1	\$5,665	\$6,004	\$6,632

**ORDER CODE SAMPLE**

LINE 1	TABLE	ITEM CODE	WIDTH	DEPTH	LAMINATE
		TDEWT	W96	D48	M1
LINE 1.1	POWER & DATA	POWER OPTION	FINISH / TRIM FINISH / COVER CODE	BODY FINISH / OPTION	POWER QTY
		AF2RE	SLV	D	1

**Features & Specifications**

No Charge Options  
Optional Extra

- Laminate codes - M1: 1" LPL, H1: 1" HPL, K1: 1.25" knife edge (top only)
- Metal base construction
- Height is 29" nominal, including levellers
- Available in all standard laminates
- For wire management please refer to BRC's accessories price guide
- For 3" center grommet (AG30A) add option code "GC" and \$76

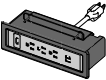
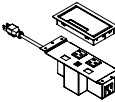
POWER & DATA					
For detailed specification, cover code finishes, data and telecom options, and pricing of each electrical modules please refer to page "Power & Data Options".					
<b>AF2RE</b> 	<b>Finish:</b> Black (BLK), Silver (SLV), White (WHT), Anodized Aluminum (BAA), Stainless Steel (BSS)	<b>AF3AE</b> 	<b>Trim Finish:</b> Black (BLK), Silver (SLV), White (WHT)	<b>AU2FE</b> 	<b>Cover Code:</b> F-AL, F-S, F-B, F-W
	<b>Option (Data &amp; Telecom):</b> A, B, C, D, E, F, G, H, J, K		<b>Body Finish:</b> White (WHT), Gray (GRY), Black (BLK), Orange (ORN), Red (RED), Green (GRN), Blue (BLU)		<b>Option (Data &amp; Telecom):</b> C, K

# Wall-Mount Boat Arced Disc Base Table

TDBWT

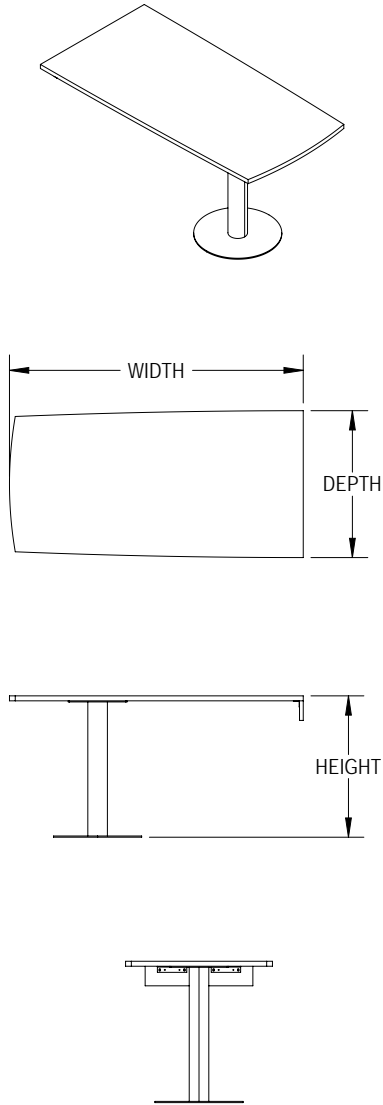

NOMINAL SIZE		POWER	LAMINATE		
WIDTH	DEPTH	QUANTITY	PRICE M1	PRICE H1	PRICE K1
60"	30"	0	\$3,306	\$3,644	\$4,260
72"	30"	0	\$3,307	\$3,645	\$4,263
60"	36"	1	\$3,295	\$3,615	\$4,182
72"	36"	1	\$3,308	\$3,646	\$4,265
72"	42"	1	\$3,722	\$4,060	\$4,681
78"	42"	1	\$3,726	\$4,063	\$4,687
84"	42"	1	\$3,726	\$4,063	\$4,687
90"	42"	1	\$3,729	\$4,068	\$4,691
96"	42"	1	\$3,729	\$4,068	\$4,691
72"	48"	1	\$3,723	\$4,061	\$4,685
78"	48"	1	\$3,727	\$4,065	\$4,689
84"	48"	1	\$3,727	\$4,065	\$4,689
90"	48"	1	\$3,730	\$4,069	\$4,694
96"	48"	1	\$3,730	\$4,069	\$4,694
72"	54"	1	\$4,356	\$4,694	\$5,316
78"	54"	1	\$4,359	\$4,698	\$5,324
84"	54"	1	\$4,359	\$4,698	\$5,324
90"	54"	1	\$4,363	\$4,700	\$5,330
96"	54"	1	\$4,363	\$4,700	\$5,330
72"	60"	1	\$5,659	\$5,998	\$6,622
78"	60"	1	\$5,663	\$6,000	\$6,626
84"	60"	1	\$5,663	\$6,000	\$6,626
90"	60"	1	\$5,665	\$6,004	\$6,632
96"	60"	1	\$5,665	\$6,004	\$6,632

**ORDER CODE SAMPLE**

LINE 1	TABLE	ITEM CODE	WIDTH	DEPTH	LAMINATE	OPTION
		TDBWT	W96	D48	M1	CC
LINE 1.1	POWER & DATA	POWER OPTION	FINISH / TRIM FINISH / COVER CODE	BODY FINISH / OPTION	POWER QTY	
		AF2RE	SLV	D	1	

**Features & Specifications**

No Charge Options  
Optional Extra

- Laminate codes - M1: 1" LPL, H1: 1" HPL, K1: 1.25" knife edge (top only)
- Metal base construction
- Height is 29" nominal, including levellers
- Available in all standard laminates
- For 3" curved corners add option code "CC" and \$349
- For wire management please refer to BRC's accessories price guide
- For 3" center grommet (AG30A) add option code "GC" and \$76

**POWER & DATA** For detailed specification, cover code finishes, data and telecom options, and pricing of each electrical modules please refer to page "Power & Data Options".

 <p><b>AF2RE</b></p>	<p><b>Finish:</b> Black (BLK), Silver (SLV), White (WHT), Anodized Aluminum (BAA), Stainless Steel (BSS)</p>	 <p><b>AF3AE</b></p>	<p><b>Trim Finish:</b> Black (BLK), Silver (SLV), White (WHT)</p>	 <p><b>AU2FE</b></p>	<p><b>Cover Code:</b> F-AL, F-S, F-B, F-W</p>
	<p><b>Option (Data &amp; Telecom):</b> A, B, C, D, E, F, G, H, J, K</p>		<p><b>Body Finish:</b> White (WHT), Gray (GRY), Black (BLK), Orange (ORN), Red (RED), Green (GRN), Blue (BLU)</p>		<p><b>Option (Data &amp; Telecom):</b> C, K</p>

PRODUCT MAP  
CONFERENCE TABLES  
MEDIA TABLES  
PARSONS TABLES  
MEETING & CASUAL TABLES  
NEST TRAINING TABLES  
www.brc.group

# Wall-Mount Trapezoid Disc Base Table

TDTWT

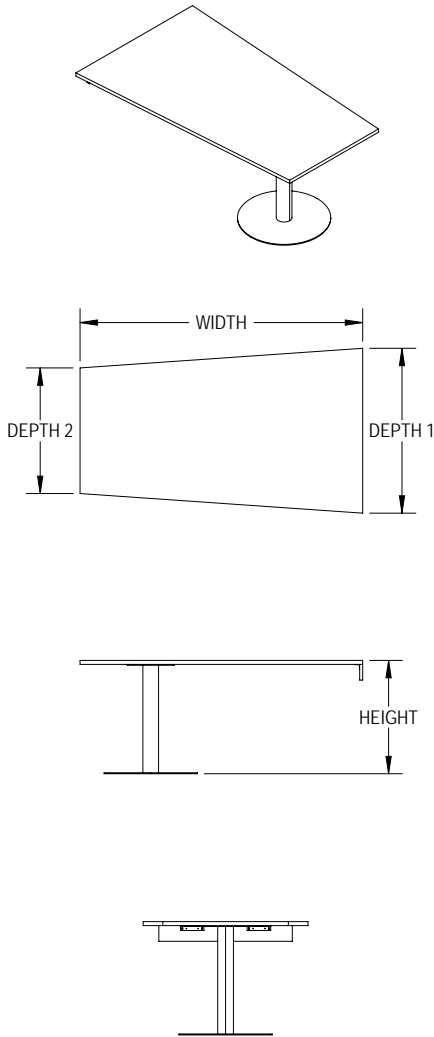

NOMINAL SIZE			POWER	LAMINATE		
WIDTH	DEPTH 1	DEPTH 2		QUANTITY	PRICE M1	PRICE H1
72"	42"	32"	0	\$3,722	\$4,060	\$4,681
78"	42"	32"	0	\$3,726	\$4,063	\$4,687
84"	42"	32"	1	\$3,726	\$4,063	\$4,687
90"	42"	32"	1	\$3,729	\$4,068	\$4,691
96"	42"	32"	1	\$3,729	\$4,068	\$4,691
72"	48"	38"	1	\$3,723	\$4,061	\$4,685
78"	48"	38"	1	\$3,727	\$4,065	\$4,689
84"	48"	38"	1	\$3,727	\$4,065	\$4,689
90"	48"	38"	1	\$3,730	\$4,069	\$4,694
96"	48"	38"	1	\$3,730	\$4,069	\$4,694
72"	54"	44"	1	\$4,356	\$4,694	\$5,316
78"	54"	44"	1	\$4,359	\$4,698	\$5,324
84"	54"	44"	1	\$4,359	\$4,698	\$5,324
90"	54"	44"	1	\$4,363	\$4,700	\$5,330
96"	54"	44"	1	\$4,363	\$4,700	\$5,330
72"	60"	50"	1	\$5,659	\$5,998	\$6,622
78"	60"	50"	1	\$5,663	\$6,000	\$6,626
84"	60"	50"	1	\$5,663	\$6,000	\$6,626
90"	60"	50"	1	\$5,665	\$6,004	\$6,632
96"	60"	50"	1	\$5,665	\$6,004	\$6,632

**ORDER CODE SAMPLE**

LINE 1	TABLE	ITEM CODE	WIDTH	DEPTH 1	DEPTH 2	LAMINATE	OPTION
		TDTWT	W96	D48	D38	M1	CC
LINE 1.1	POWER & DATA	POWER OPTION	FINISH / TRIM FINISH / COVER CODE	BODY FINISH / OPTION	POWER QTY		
		AF2RE	SLV	D	1		

**Features & Specifications**

No Charge Options  
Optional Extra

- Laminate codes - M1: 1" LPL, H1: 1" HPL, K1: 1.25" knife edge (top only)
- Metal base construction
- Height is 29" nominal, including levers
- Available in all standard laminates
- For 3" curved corners add option code "CC" and \$349
- For wire management please refer to BRC's accessories price guide
- For 3" center grommet (AG30A) add option code "GC" and \$76

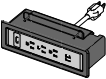
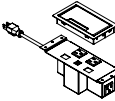
POWER & DATA	For detailed specification, cover code finishes, data and telecom options, and pricing of each electrical modules please refer to page "Power & Data Options".				
<b>AF2RE</b> 	<b>Finish:</b> Black (BLK), Silver (SLV), White (WHT), Anodized Aluminum (BAA), Stainless Steel (BSS)	<b>AF3AE</b> 	<b>Trim Finish:</b> Black (BLK), Silver (SLV), White (WHT)	<b>AU2FE</b> 	<b>Cover Code:</b> F-AL, F-S, F-B, F-W
	<b>Option (Data &amp; Telecom):</b> A, B, C, D, E, F, G, H, J, K		<b>Body Finish:</b> White (WHT), Gray (GRY), Black (BLK), Orange (ORN), Red (RED), Green (GRN), Blue (BLU)		<b>Option (Data &amp; Telecom):</b> C, K

PRODUCT MAP  
CONFERENCE TABLES  
MEDIA TABLES  
PARSONS TABLES  
MEETING & CASUAL TABLES  
NEST TRAINING TABLES  
www.brc.group

# Wall-Mount Rectangle Panel Base Table

TPRWT

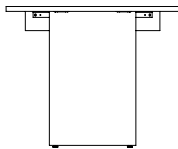
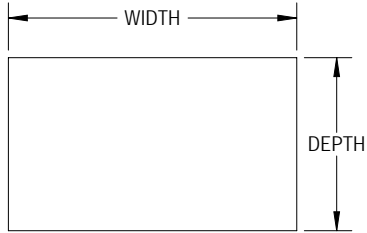
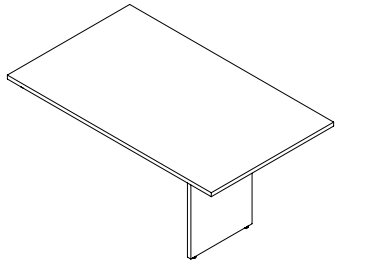

NOMINAL SIZE		POWER	LAMINATE		
WIDTH	DEPTH	QUANTITY	PRICE M1	PRICE H1	PRICE K1
60"	30"	0	\$1,419	\$1,684	\$2,279
72"	30"	0	\$1,455	\$1,727	\$2,305
60"	36"	1	\$1,444	\$1,721	\$2,212
72"	36"	1	\$1,480	\$1,761	\$2,308
72"	42"	1	\$1,480	\$1,761	\$2,310
78"	42"	1	\$1,499	\$1,783	\$2,326
84"	42"	1	\$1,733	\$2,017	\$2,562
90"	42"	1	\$1,752	\$2,038	\$2,578
96"	42"	1	\$1,763	\$2,050	\$2,590
72"	48"	1	\$1,512	\$1,793	\$2,345
78"	48"	1	\$1,530	\$1,813	\$2,360
84"	48"	1	\$1,764	\$2,047	\$2,596
90"	48"	1	\$1,783	\$2,070	\$2,613
96"	48"	1	\$1,794	\$2,082	\$2,625
72"	54"	1	\$1,545	\$1,825	\$2,379
78"	54"	1	\$1,561	\$1,845	\$2,397
84"	54"	1	\$1,798	\$2,081	\$2,631
90"	54"	1	\$1,814	\$2,101	\$2,648
96"	54"	1	\$1,826	\$2,113	\$2,659
72"	60"	1	\$1,576	\$1,858	\$2,413
78"	60"	1	\$1,593	\$1,878	\$2,428
84"	60"	1	\$1,829	\$2,113	\$2,665
90"	60"	1	\$1,848	\$2,133	\$2,680
96"	60"	1	\$1,859	\$2,144	\$2,692

**ORDER CODE SAMPLE**

LINE 1	TABLE	ITEM CODE	WIDTH	DEPTH	LAMINATE	OPTION
		TPRWT	W96	D48	M1	CC
LINE 1.1	POWER & DATA	POWER OPTION	FINISH / TRIM FINISH / COVER CODE	BODY FINISH / OPTION	POWER QTY	
		AF2RE	SLV	D	1	

**Features & Specifications**

No Charge Options  
Optional Extra

- Laminate codes - M1: 1" LPL, H1: 1" HPL, K1: 1.25" knife edge (top only)
- Base laminate is 1" LPL
- Height is 29" nominal, including levellers
- Available in all standard laminates
- For 3" curved corners add option code "CC" and \$349
- For wire management please refer to BRC's accessories price guide
- For 3" center grommet (AG30A) add option code "GC" and \$76

**POWER & DATA** For detailed specification, cover code finishes, data and telecom options, and pricing of each electrical modules please refer to page "Power & Data Options".

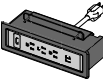
 <p><b>AF2RE</b></p>	<p><b>Finish:</b> Black (BLK), Silver (SLV), White (WHT), Anodized Aluminum (BAA), Stainless Steel (BSS)</p>	 <p><b>AF3AE</b></p>	<p><b>Trim Finish:</b> Black (BLK), Silver (SLV), White (WHT)</p>	 <p><b>AU2FE</b></p>	<p><b>Cover Code:</b> F-AL, F-S, F-B, F-W</p>
	<p><b>Option (Data &amp; Telecom):</b> A, B, C, D, E, F, G, H, J, K</p>		<p><b>Body Finish:</b> White (WHT), Gray (GRY), Black (BLK), Orange (ORN), Red (RED), Green (GRN), Blue (BLU)</p>		<p><b>Option (Data &amp; Telecom):</b> C, K</p>

# Wall-Mount Arced Boat Panel Base Table

TPBWT

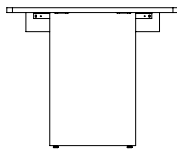
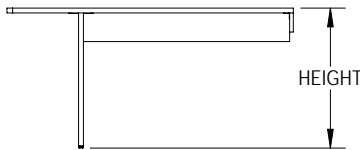
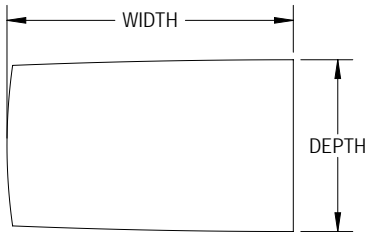
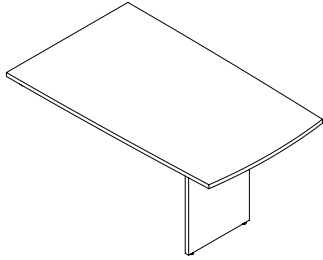

NOMINAL SIZE		POWER	LAMINATE		
WIDTH	DEPTH	QUANTITY	PRICE M1	PRICE H1	PRICE K1
60"	30"	0	\$1,525	\$1,848	\$2,435
72"	30"	0	\$1,550	\$1,871	\$2,460
60"	36"	1	\$1,516	\$1,819	\$2,360
72"	36"	1	\$1,551	\$1,873	\$2,462
72"	42"	1	\$1,553	\$1,875	\$2,465
78"	42"	1	\$1,568	\$1,889	\$2,481
84"	42"	1	\$1,802	\$2,123	\$2,718
90"	42"	1	\$1,816	\$2,139	\$2,733
96"	42"	1	\$1,829	\$2,149	\$2,746
72"	48"	1	\$1,584	\$1,909	\$2,499
78"	48"	1	\$1,601	\$1,922	\$2,517
84"	48"	1	\$1,835	\$2,157	\$2,751
90"	48"	1	\$1,851	\$2,172	\$2,769
96"	48"	1	\$1,862	\$2,184	\$2,780
72"	54"	1	\$1,621	\$1,942	\$2,537
78"	54"	1	\$1,634	\$1,957	\$2,552
84"	54"	1	\$1,871	\$2,193	\$2,788
90"	54"	1	\$1,885	\$2,207	\$2,805
96"	54"	1	\$1,896	\$2,219	\$2,818
72"	60"	1	\$1,652	\$1,975	\$2,568
78"	60"	1	\$1,667	\$1,989	\$2,583
84"	60"	1	\$1,902	\$2,223	\$2,820
90"	60"	1	\$1,916	\$2,238	\$2,837
96"	60"	1	\$1,929	\$2,249	\$2,849

**ORDER CODE SAMPLE**

LINE 1	TABLE	ITEM CODE	WIDTH	DEPTH	LAMINATE	OPTION
		TPBWT	W96	D48	M1	CC
LINE 1.1	POWER & DATA	POWER OPTION	FINISH / TRIM FINISH / COVER CODE	BODY FINISH / OPTION	POWER QTY	
		AF2RE	SLV	D	1	

**Features & Specifications**

No Charge Options  
Optional Extra

- Laminate codes - M1: 1" LPL, H1: 1" HPL, K1: 1.25" knife edge (top only)
- Base laminate is 1" LPL
- Height is 29" nominal, including levellers
- Available in all standard laminates
- For 3" curved corners add option code "CC" and \$349
- For wire management please refer to BRC's accessories price guide
- For 3" center grommet (AG30A) add option code "GC" and \$76

**POWER & DATA** For detailed specification, cover code finishes, data and telecom options, and pricing of each electrical modules please refer to page "Power & Data Options".

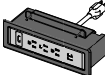
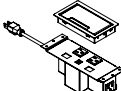
 <p><b>AF2RE</b></p>	<p><b>Finish:</b> Black (BLK), Silver (SLV), White (WHT), Anodized Aluminum (BAA), Stainless Steel (BSS)</p>	 <p><b>AF3AE</b></p>	<p><b>Trim Finish:</b> Black (BLK), Silver (SLV), White (WHT)</p>	 <p><b>AU2FE</b></p>	<p><b>Cover Code:</b> F-AL, F-S, F-B, F-W</p>
	<p><b>Option (Data &amp; Telecom):</b> A, B, C, D, E, F, G, H, J, K</p>		<p><b>Body Finish:</b> White (WHT), Gray (GRY), Black (BLK), Orange (ORN), Red (RED), Green (GRN), Blue (BLU)</p>		<p><b>Option (Data &amp; Telecom):</b> C, K</p>

# Wall-Mount Bullet End Panel Base Table

TPEWT

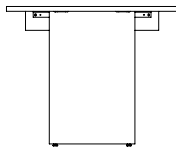
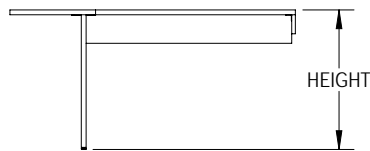
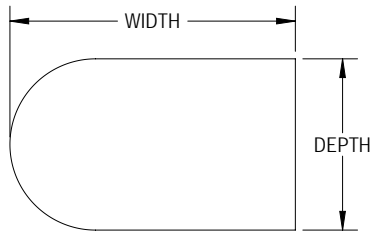
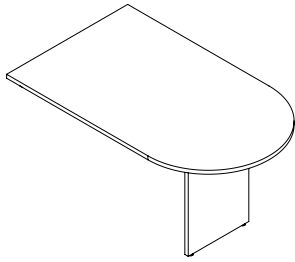

NOMINAL SIZE		POWER	LAMINATE		
WIDTH	DEPTH	QUANTITY	PRICE M1	PRICE H1	PRICE K1
60"	30"	0	\$1,525	\$1,848	\$2,435
72"	30"	0	\$1,550	\$1,871	\$2,460
60"	36"	1	\$1,516	\$1,819	\$2,360
72"	36"	1	\$1,551	\$1,873	\$2,462
72"	42"	1	\$1,553	\$1,875	\$2,465
78"	42"	1	\$1,568	\$1,889	\$2,481
84"	42"	1	\$1,802	\$2,123	\$2,718
90"	42"	1	\$1,816	\$2,139	\$2,733
96"	42"	1	\$1,829	\$2,149	\$2,746
72"	48"	1	\$1,584	\$1,909	\$2,499
78"	48"	1	\$1,601	\$1,922	\$2,517
84"	48"	1	\$1,835	\$2,157	\$2,751
90"	48"	1	\$1,851	\$2,172	\$2,769
96"	48"	1	\$1,862	\$2,184	\$2,780
72"	54"	1	\$1,621	\$1,942	\$2,537
78"	54"	1	\$1,634	\$1,957	\$2,552
84"	54"	1	\$1,871	\$2,193	\$2,788
90"	54"	1	\$1,885	\$2,207	\$2,805
96"	54"	1	\$1,896	\$2,219	\$2,818
72"	60"	1	\$1,652	\$1,975	\$2,568
78"	60"	1	\$1,667	\$1,989	\$2,583
84"	60"	1	\$1,902	\$2,223	\$2,820
90"	60"	1	\$1,916	\$2,238	\$2,837
96"	60"	1	\$1,929	\$2,249	\$2,849

**ORDER CODE SAMPLE**

LINE 1	TABLE	ITEM CODE	WIDTH	DEPTH	LAMINATE
		TPEWT	W96	D48	M1
LINE 1.1	POWER & DATA	POWER OPTION	FINISH / TRIM FINISH / COVER CODE	BODY FINISH / OPTION	POWER QTY
		AF2RE	SLV	D	1

**Features & Specifications**

No Charge Options  
Optional Extra

- Laminate codes - M1: 1" LPL, H1: 1" HPL, K1: 1.25" knife edge (top only)
- Base laminate is 1" LPL
- Height is 29" nominal, including levellers
- Available in all standard laminates
- For wire management please refer to BRC's accessories price guide
- For 3" center grommet (AG30A) add option code "GC" and \$76

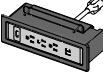
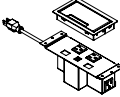
POWER & DATA	For detailed specification, cover code finishes, data and telecom options, and pricing of each electrical modules please refer to page "Power & Data Options".				
<b>AF2RE</b> 	<b>Finish:</b> Black (BLK), Silver (SLV), White (WHT), Anodized Aluminum (BAA), Stainless Steel (BSS)	<b>AF3AE</b> 	<b>Trim Finish:</b> Black (BLK), Silver (SLV), White (WHT)	<b>AU2FE</b> 	<b>Cover Code:</b> F-AL, F-S, F-B, F-W
	<b>Option (Data &amp; Telecom):</b> A, B, C, D, E, F, G, H, J, K		<b>Body Finish:</b> White (WHT), Gray (GRY), Black (BLK), Orange (ORN), Red (RED), Green (GRN), Blue (BLU)		<b>Option (Data &amp; Telecom):</b> C, K

# Bullet End Disc Base Extension Table, Seated Height

TDTET

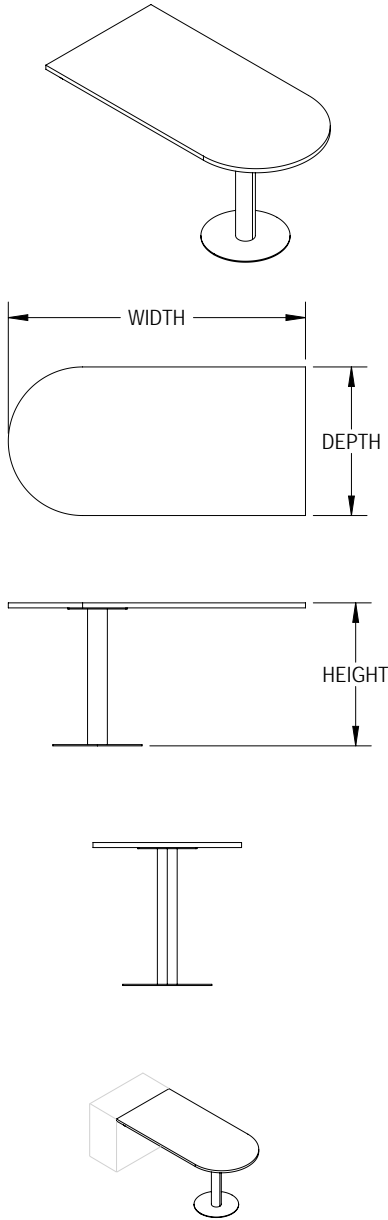

NOMINAL SIZE			LAMINATE		
WIDTH	DEPTH	HEIGHT	PRICE M1	PRICE H1	PRICE K1
72"	36"	29"	\$3,350	\$3,654	\$4,213
84"	36"	29"	\$3,354	\$3,657	\$4,219
96"	36"	29"	\$3,357	\$3,662	\$4,222
120"	36"	29"	\$3,892	\$4,246	\$4,895
144"	36"	29"	\$3,897	\$4,248	\$4,901
180"	36"	29"	\$3,900	\$4,254	\$4,905
72"	42"	29"	\$3,722	\$4,060	\$4,681
84"	42"	29"	\$3,726	\$4,063	\$4,687
96"	42"	29"	\$3,729	\$4,068	\$4,691
120"	42"	29"	\$4,324	\$4,717	\$5,438
144"	42"	29"	\$4,329	\$4,720	\$5,445
180"	42"	29"	\$4,333	\$4,726	\$5,449
72"	48"	29"	\$3,723	\$4,061	\$4,685
84"	48"	29"	\$3,727	\$4,065	\$4,689
96"	48"	29"	\$3,730	\$4,069	\$4,694
120"	48"	29"	\$4,282	\$4,671	\$5,388
144"	48"	29"	\$4,287	\$4,675	\$5,393
180"	48"	29"	\$4,290	\$4,680	\$5,399
72"	54"	29"	\$4,356	\$4,694	\$5,316
84"	54"	29"	\$4,359	\$4,698	\$5,324
96"	54"	29"	\$4,363	\$4,700	\$5,330
120"	54"	29"	\$5,010	\$5,399	\$6,114
144"	54"	29"	\$5,013	\$5,403	\$6,123
180"	54"	29"	\$5,018	\$5,405	\$6,130
72"	60"	29"	\$5,659	\$5,998	\$6,622
84"	60"	29"	\$5,663	\$6,000	\$6,626
96"	60"	29"	\$5,665	\$6,004	\$6,632
120"	60"	29"	\$6,508	\$6,898	\$7,616
144"	60"	29"	\$6,513	\$6,900	\$7,620
180"	60"	29"	\$6,515	\$6,905	\$7,627

**ORDER CODE SAMPLE**

LINE 1	TABLE	ITEM CODE	WIDTH	DEPTH	HEIGHT	LAMINATE
		TDTET	W96	D48	H29	M1

**Features & Specifications**

**No Charge Options**

- Laminate codes - M1: 1" LPL, H1: 1" HPL, K1: 1.25" knife edge (top only)
- Metal base construction with 1" of levelling
- Includes V under surface support bars where applicable
- Includes flush plates
- 108" Wide top and larger is in two sections with seam
- Available in all standard laminates

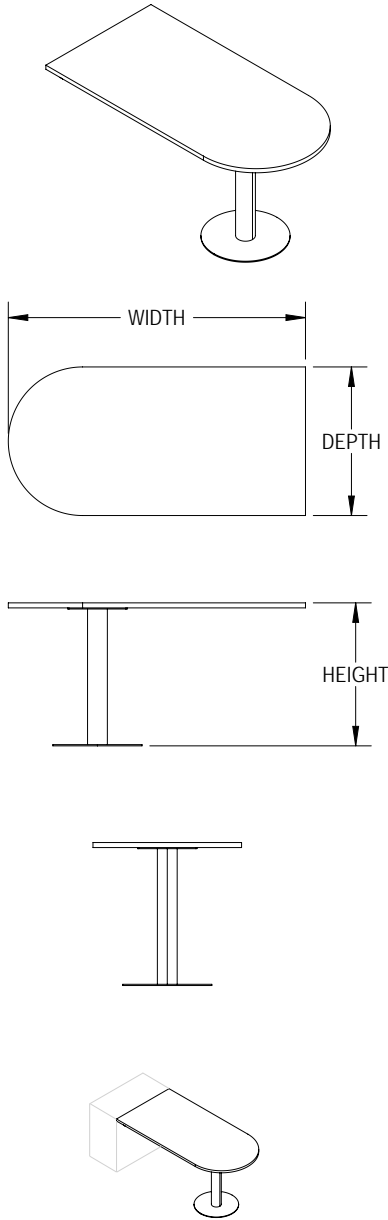

NOMINAL SIZE			LAMINATE		
WIDTH	DEPTH	HEIGHT	PRICE M1	PRICE H1	PRICE K1
72"	36"	36"	\$3,520	\$3,840	\$4,427
84"	36"	36"	\$3,524	\$3,843	\$4,434
96"	36"	36"	\$3,528	\$3,848	\$4,437
120"	36"	36"	\$4,090	\$4,462	\$5,144
144"	36"	36"	\$4,095	\$4,464	\$5,150
180"	36"	36"	\$4,098	\$4,471	\$5,154
72"	42"	36"	\$3,912	\$4,267	\$4,919
84"	42"	36"	\$3,916	\$4,270	\$4,926
96"	42"	36"	\$3,919	\$4,275	\$4,930
120"	42"	36"	\$4,544	\$4,956	\$5,714
144"	42"	36"	\$4,549	\$4,959	\$5,722
180"	42"	36"	\$4,554	\$4,967	\$5,726
72"	48"	36"	\$3,913	\$4,268	\$4,924
84"	48"	36"	\$3,917	\$4,272	\$4,928
96"	48"	36"	\$3,920	\$4,276	\$4,933
120"	48"	36"	\$4,500	\$4,908	\$5,662
144"	48"	36"	\$4,505	\$4,912	\$5,667
180"	48"	36"	\$4,508	\$4,917	\$5,673
72"	54"	36"	\$4,577	\$4,933	\$5,586
84"	54"	36"	\$4,580	\$4,937	\$5,595
96"	54"	36"	\$4,585	\$4,939	\$5,601
120"	54"	36"	\$5,265	\$5,673	\$6,424
144"	54"	36"	\$5,268	\$5,678	\$6,434
180"	54"	36"	\$5,273	\$5,680	\$6,442
72"	60"	36"	\$5,947	\$6,302	\$6,958
84"	60"	36"	\$5,951	\$6,304	\$6,962
96"	60"	36"	\$5,953	\$6,309	\$6,968
120"	60"	36"	\$6,838	\$7,248	\$8,003
144"	60"	36"	\$6,843	\$7,250	\$8,007
180"	60"	36"	\$6,845	\$7,255	\$8,014

ORDER CODE SAMPLE

LINE 1	TABLE	ITEM CODE	WIDTH	DEPTH	HEIGHT	LAMINATE
		TDTCT	W96	D48	H36	M1

Features & Specifications

No Charge Options

- Laminate codes - M1: 1" LPL, H1: 1" HPL, K1: 1.25" knife edge (top only)
- Metal base construction with 1" of levelling
- Includes V under surface support bars where applicable
- Includes flush plates
- 108" Wide top and larger is in two sections with seam
- Available in all standard laminates

# Bullet End Disc Base Extension Table, Bar Height

TDTBT

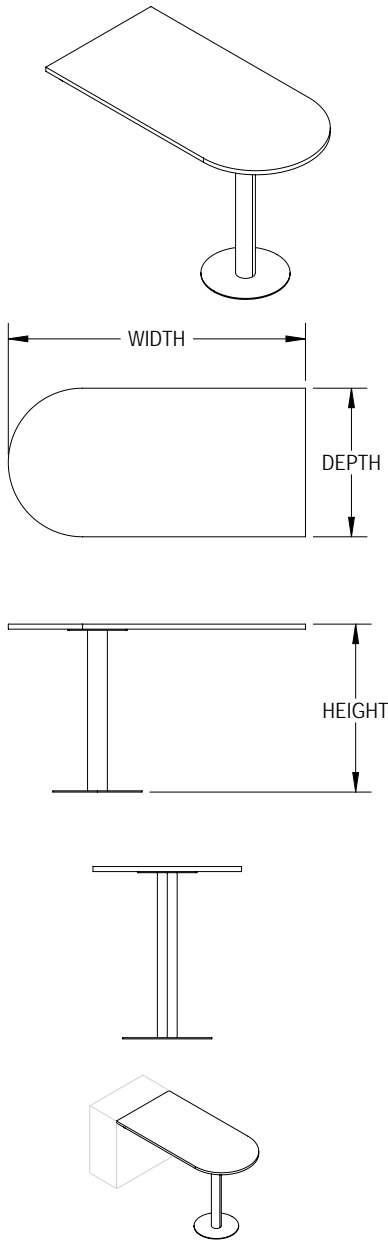

NOMINAL SIZE			LAMINATE		
WIDTH	DEPTH	HEIGHT	PRICE M1	PRICE H1	PRICE K1
72"	36"	42"	\$3,699	\$4,035	\$4,652
84"	36"	42"	\$3,704	\$4,039	\$4,659
96"	36"	42"	\$3,708	\$4,044	\$4,662
120"	36"	42"	\$4,298	\$4,689	\$5,405
144"	36"	42"	\$4,303	\$4,691	\$5,411
180"	36"	42"	\$4,307	\$4,698	\$5,416
72"	42"	42"	\$4,111	\$4,484	\$5,169
84"	42"	42"	\$4,115	\$4,487	\$5,177
96"	42"	42"	\$4,118	\$4,492	\$5,181
120"	42"	42"	\$4,775	\$5,207	\$6,004
144"	42"	42"	\$4,780	\$5,211	\$6,013
180"	42"	42"	\$4,785	\$5,220	\$6,017
72"	48"	42"	\$4,112	\$4,485	\$5,175
84"	48"	42"	\$4,116	\$4,489	\$5,179
96"	48"	42"	\$4,119	\$4,493	\$5,184
120"	48"	42"	\$4,729	\$5,157	\$5,950
144"	48"	42"	\$4,734	\$5,161	\$5,955
180"	48"	42"	\$4,737	\$5,166	\$5,961
72"	54"	42"	\$4,810	\$5,184	\$5,870
84"	54"	42"	\$4,813	\$5,188	\$5,879
96"	54"	42"	\$4,818	\$5,190	\$5,886
120"	54"	42"	\$5,532	\$5,961	\$6,750
144"	54"	42"	\$5,535	\$5,966	\$6,760
180"	54"	42"	\$5,541	\$5,968	\$6,770
72"	60"	42"	\$6,249	\$6,622	\$7,311
84"	60"	42"	\$6,253	\$6,624	\$7,316
96"	60"	42"	\$6,255	\$6,629	\$7,322
120"	60"	42"	\$7,185	\$7,616	\$8,410
144"	60"	42"	\$7,191	\$7,618	\$8,414
180"	60"	42"	\$7,193	\$7,623	\$8,421

**ORDER CODE SAMPLE**

LINE 1	TABLE	ITEM CODE	WIDTH	DEPTH	HEIGHT	LAMINATE
		TDTBT	W96	D48	H42	M1

**Features & Specifications**

**No Charge Options**

- Laminate codes - M1: 1" LPL, H1: 1" HPL, K1: 1.25" knife edge (top only)
- Metal base construction with 1" of levelling
- Includes V under surface support bars where applicable
- Includes flush plates
- 108" Wide top and larger is in two sections with seam
- Available in all standard laminates

# Media Tables









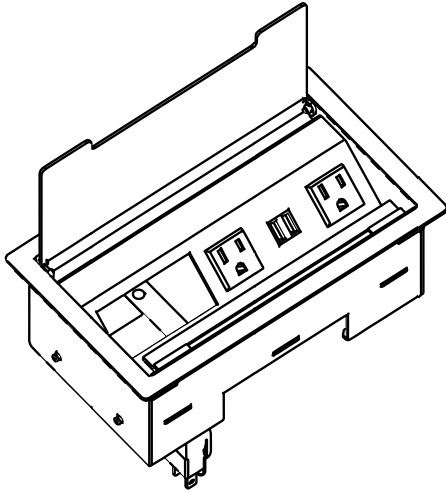



Meetings and presentations made easy. BRC's Media Tables are available in a large selection of sizes to fit every office space. A large back panel allows for sturdy mounting of extra wide monitors or TV screens. Easy access integrated wire management ensures that all the cables stay hidden and organized. Available with several standard electric and data options for easy ordering in addition to endless custom possibilities.

# Power & Data Options: Media Tables

## AF2RE: Interact G2 Power Module

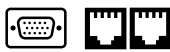

AF2RE	FINISH	
	PRICE (BLACK, SILVER, WHITE)	PRICE (ANODIZED ALUMINUM, STAINLESS STEEL)
FEATURES & SPECIFICATIONS		
<ul style="list-style-type: none"> <li>• Two power outlets on top</li> <li>• Additional power outlet on bottom for daisy chaining</li> <li>• Two USB ports</li> <li>• Hinged lid with brush gasket</li> <li>• 144" Black corded plug</li> <li>• Finish options: black, silver or white, Brushed anodized aluminum, brushed stainless steel</li> <li>• Product ships with blank plate unless additional options below are selected when ordering</li> </ul>	1,221	1,921

OPTION	FEATURE(S)	PRICE
A	 HDMI	ADD 363
B	 RJ45 CAT6	ADD 225
C	 (2) RJ45 CAT6	ADD 447
D	 (3) RJ45 CAT6	ADD 670
E	 RJ11 CAT3, RJ45 CAT6, USB	ADD 752
F	 RJ11 CAT3, RJ45 CAT6	ADD 337
G	 RJ11 CAT3, (2) RJ45 CAT6	ADD 558
H	 (3) RJ45 CAT5E	ADD 670
J	 VGA, (2) RJ45 CAT6	ADD 713
K	 VGA, RJ45 CAT6, STEREO 3.5	ADD 603

### ORDER CODE SAMPLE

LINE 1	TABLE	ITEM CODE	WIDTH	DEPTH	LAMINATE	OPTION
		TMR TT	W96	D48	M1	CC
LINE 1.1	POWER & DATA	POWER OPTION	FINISH / TRIM FINISH / COVER CODE	BODY FINISH / OPTION	POWER QTY	
		AF2RE	SILVER	D	1	

# Power & Data Options: Media Tables

## AF3AE: Trio Flush Mount

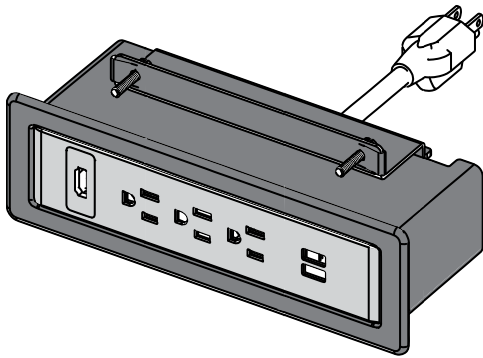

### AF3AE

FEATURES & SPECIFICATIONS	PRICE
<ul style="list-style-type: none"> <li>• Triple outlet</li> <li>• Two USB ports</li> <li>• 72" Corded plug</li> <li>• Finish options: Trim: black, silver or white Body: white, grey, black, orange, red, green, blue</li> </ul>	688

#### ORDER CODE SAMPLE

LINE 1	TABLE	ITEM CODE	WIDTH	DEPTH	LAMINATE	OPTION
		TMRTT	W96	D48	M1	CC
LINE 1.1	POWER & DATA	POWER OPTION	FINISH / TRIM FINISH / COVER CODE	BODY FINISH / OPTION	POWER QTY	
				AF3AE	SILVER	BLUE

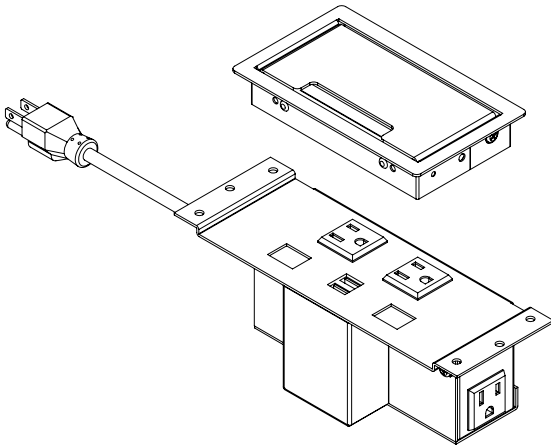

# Power & Data Options: Media Tables

## AU2FE: Vila Undermount



AU2FE	
FEATURES & SPECIFICATIONS	PRICE
<ul style="list-style-type: none"> <li>• Two power outlets</li> <li>• Two USB charging ports</li> <li>• 72" Black corded plug</li> <li>• Base finish options: black or silver</li> <li>• Optional data, video and stereo options as per below</li> <li>• Select cover grommet to complete product</li> </ul>	814

COVER		
MODEL	FINISH	PRICE
F-AL	BRUSHED ALUMINUM	ADD 516
F-S	SILVER PAINT	ADD 259
F-B	BLACK PAINT	ADD 259
F-W	GLOSS WHITE PAINT	ADD 259

OPTION	FEATURE(S)	PRICE
C	 (2) RJ45 CAT6	ADD 469
K	 VGA, RJ45 CAT6, STEREO 3.5	ADD 776

### ORDER CODE SAMPLE

LINE 1	TABLE	ITEM CODE	WIDTH	DEPTH	LAMINATE	OPTION
		TMR TT	W96	D48	M1	CC
LINE 1.1	POWER & DATA	POWER OPTION	FINISH / TRIM FINISH / COVER CODE	BODY FINISH / OPTION	POWER QTY	
		AU2FE	F-S	K	1	

# Wire Management & Power & Data Location: Media Tables

## Wire Management

Wire management for media tables can be accommodated through the back panel and the front base. Both have removable panels for easy wire access and routing. Wire managers (AWMCA) are included with tables that are ordered with power modules. Additional items, such as power bars, are not included but can be ordered separately, if required, using the Accessories Price Guide on BRC's website.

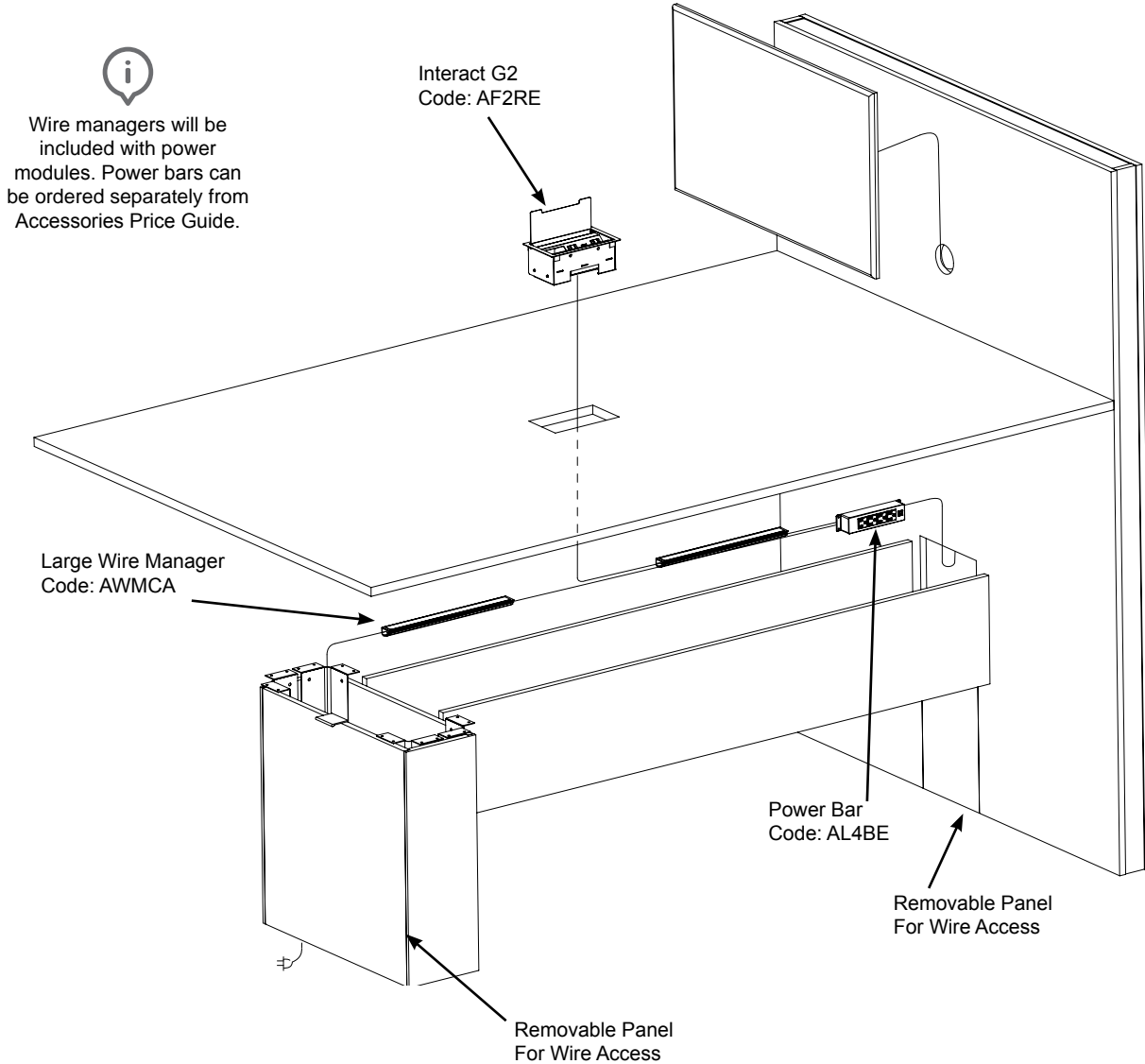

## Power Locations

By default, electrical modules, when specified from this price guide, are located as per below. If one electrical module is specified it will be located on the center. If there are two specified, they will be distanced equally in the center.

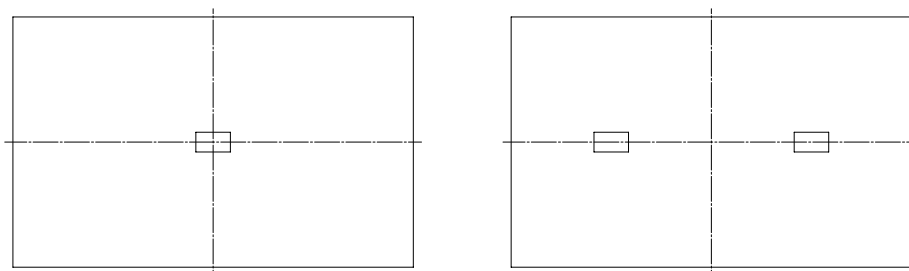

# Rectangle Media Table, Seated Height

TMRTT

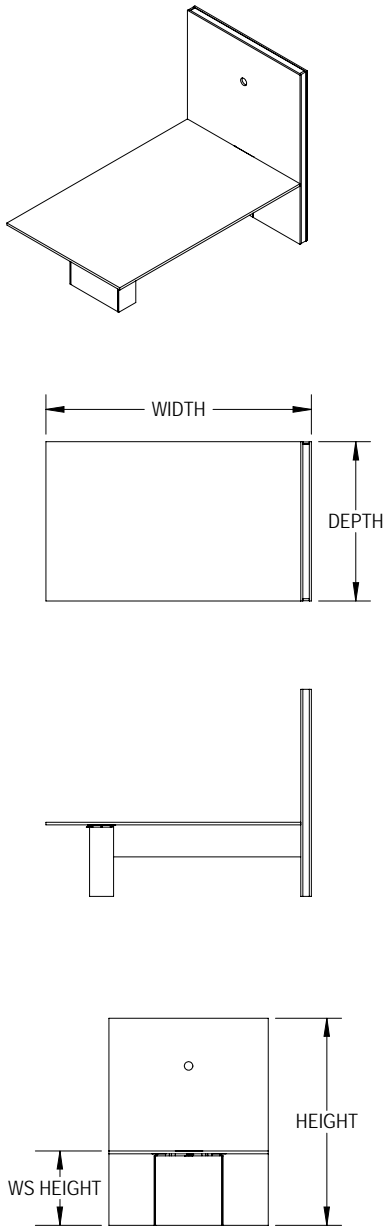

NOMINAL SIZE				POWER	LAMINATE		
WIDTH	DEPTH	WS HEIGHT	HEIGHT	QUANTITY	PRICE M1	PRICE H1	PRICE K1
60"	48"	29"	66"	1	\$2,190	\$2,510	\$3,100
72"	48"	29"	66"	1, 2	\$2,305	\$2,642	\$3,263
84"	48"	29"	66"	1, 2	\$2,313	\$2,650	\$3,274
96"	48"	29"	66"	1, 2	\$2,319	\$2,658	\$3,283
120"	48"	29"	66"	1, 2	\$2,551	\$2,924	\$3,612
60"	60"	29"	66"	1	\$2,283	\$2,604	\$3,195
72"	60"	29"	66"	1, 2	\$2,403	\$2,741	\$3,363
84"	60"	29"	66"	1, 2	\$2,409	\$2,747	\$3,373
96"	60"	29"	66"	1, 2	\$2,417	\$2,754	\$3,383
120"	60"	29"	66"	1, 2	\$2,659	\$3,030	\$3,722
60"	48"	29"	72"	1	\$2,190	\$2,511	\$3,100
72"	48"	29"	72"	1, 2	\$2,305	\$2,643	\$3,263
84"	48"	29"	72"	1, 2	\$2,313	\$2,650	\$3,274
96"	48"	29"	72"	1, 2	\$2,319	\$2,659	\$3,283
120"	48"	29"	72"	1, 2	\$2,551	\$2,925	\$3,612
60"	48"	29"	72"	1	\$2,283	\$2,604	\$3,195
72"	60"	29"	72"	1, 2	\$2,403	\$2,741	\$3,363
84"	60"	29"	72"	1, 2	\$2,410	\$2,748	\$3,374
96"	60"	29"	72"	1, 2	\$2,417	\$2,754	\$3,384
120"	60"	29"	72"	1, 2	\$2,659	\$3,030	\$3,723
60"	48"	29"	78"	1	\$2,191	\$2,511	\$3,100
72"	48"	29"	78"	1, 2	\$2,306	\$2,643	\$3,263
84"	48"	29"	78"	1, 2	\$2,313	\$2,650	\$3,275
96"	48"	29"	78"	1, 2	\$2,320	\$2,659	\$3,284
120"	48"	29"	78"	1, 2	\$2,552	\$2,925	\$3,613
60"	48"	29"	78"	1	\$2,283	\$2,605	\$3,196
72"	60"	29"	78"	1, 2	\$2,403	\$2,742	\$3,364
84"	60"	29"	78"	1, 2	\$2,410	\$2,748	\$3,374
96"	60"	29"	78"	1, 2	\$2,417	\$2,756	\$3,384
120"	60"	29"	78"	1, 2	\$2,659	\$3,032	\$3,723

**ORDER CODE SAMPLE**

LINE 1	TABLE	ITEM CODE	WIDTH	DEPTH	WS HEIGHT	HEIGHT	LAMINATE	OPTION
		TMRTT	W96	D42	WS29	H72	M1	TV
LINE 1.1	POWER & DATA	POWER OPTION	FINISH / TRIM FINISH / COVER CODE		BODY FINISH / OPTION	POWER QTY		
		AF2RE	SLV		D	1		

**Features & Specifications**

No Charge Options  
Optional Extra

- Laminate codes - M1: 1" LPL, H1: 1" HPL, K1: 1.25" knife edge (top only)
- All laminates except for worksurface are 3/4" LPL
- Wire management through the back panel and front base
- Worksurface Height is 29" nominal, including levellers
- 120" Width worksurfaces will be in 2 sections and have seam & include 2 bases
- Available in all standard laminates
- For back panel TV/Monitor mount, add code 'TV' and \$325

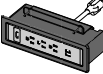
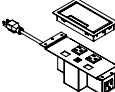
POWER & DATA	For detailed specification, cover code finishes, data and telecom options, and pricing of each electrical modules please refer to page "Power & Data Options".				
<b>AF2RE</b> 	<b>Finish:</b> Black (BLK), Silver (SLV), White (WHT), Anodized Aluminum (BAA), Stainless Steel (BSS)	<b>AF3AE</b> 	<b>Trim Finish:</b> Black (BLK), Silver (SLV), White (WHT)	<b>AU2FE</b> 	<b>Cover Code:</b> F-AL, F-S, F-B, F-W
	<b>Option (Data &amp; Telecom):</b> A, B, C, D, E, F, G, H, J, K		<b>Body Finish:</b> White (WHT), Gray (GRY), Black (BLK), Orange (ORN), Red (RED), Green (GRN), Blue (BLU)		<b>Option (Data &amp; Telecom):</b> C, K

PRODUCT MAP  
CONFERENCE TABLES  
MEDIA TABLES  
PARSONS TABLES  
MEETING & CASUAL TABLES  
NEST TRAINING TABLES  
www.brc.group

# Rectangle Media Table, Counter Height

TMRCT

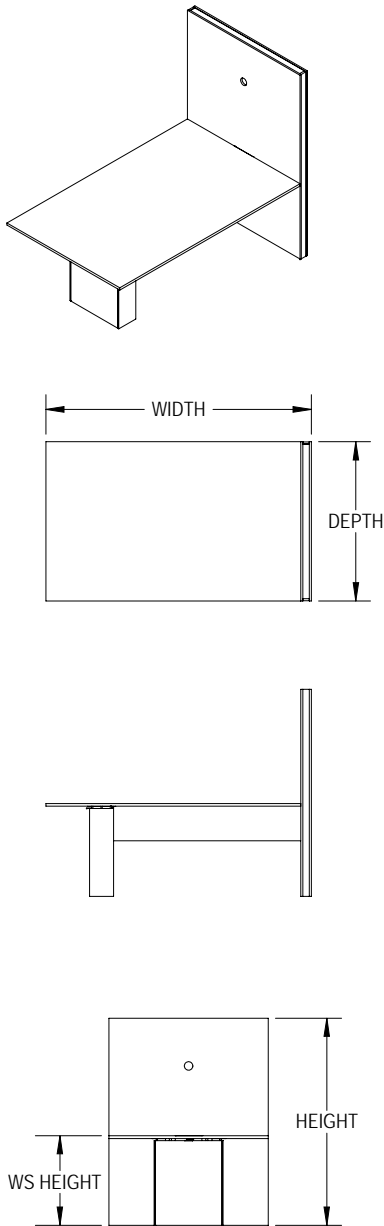

NOMINAL SIZE				POWER	LAMINATE		
WIDTH	DEPTH	WS HEIGHT	HEIGHT	QUANTITY	PRICE M1	PRICE H1	PRICE K1
60"	48"	36"	66"	1	\$2,519	\$2,887	\$3,565
72"	48"	36"	66"	1, 2	\$2,651	\$3,039	\$3,753
84"	48"	36"	66"	1, 2	\$2,660	\$3,048	\$3,766
96"	48"	36"	66"	1, 2	\$2,667	\$3,057	\$3,776
120"	48"	36"	66"	1, 2	\$2,934	\$3,363	\$4,154
60"	60"	36"	66"	1	\$2,626	\$2,995	\$3,675
72"	60"	36"	66"	1, 2	\$2,764	\$3,153	\$3,868
84"	60"	36"	66"	1, 2	\$2,771	\$3,160	\$3,879
96"	60"	36"	66"	1, 2	\$2,780	\$3,168	\$3,891
120"	60"	36"	66"	1, 2	\$3,058	\$3,485	\$4,281
60"	48"	36"	72"	1	\$2,519	\$2,888	\$3,565
72"	48"	36"	72"	1, 2	\$2,651	\$3,040	\$3,753
84"	48"	36"	72"	1, 2	\$2,660	\$3,048	\$3,766
96"	48"	36"	72"	1, 2	\$2,667	\$3,058	\$3,776
120"	48"	36"	72"	1, 2	\$2,934	\$3,364	\$4,154
60"	48"	36"	72"	1	\$2,626	\$2,995	\$3,675
72"	60"	36"	72"	1, 2	\$2,764	\$3,153	\$3,868
84"	60"	36"	72"	1, 2	\$2,772	\$3,161	\$3,881
96"	60"	36"	72"	1, 2	\$2,780	\$3,168	\$3,892
120"	60"	36"	72"	1, 2	\$3,058	\$3,485	\$4,282
60"	48"	36"	78"	1	\$2,520	\$2,888	\$3,565
72"	48"	36"	78"	1, 2	\$2,652	\$3,040	\$3,753
84"	48"	36"	78"	1, 2	\$2,660	\$3,048	\$3,767
96"	48"	36"	78"	1, 2	\$2,668	\$3,058	\$3,777
120"	48"	36"	78"	1, 2	\$2,935	\$3,364	\$4,155
60"	48"	36"	78"	1	\$2,626	\$2,996	\$3,676
72"	60"	36"	78"	1, 2	\$2,764	\$3,154	\$3,869
84"	60"	36"	78"	1, 2	\$2,772	\$3,161	\$3,881
96"	60"	36"	78"	1, 2	\$2,780	\$3,170	\$3,892
120"	60"	36"	78"	1, 2	\$3,058	\$3,487	\$4,282

**ORDER CODE SAMPLE**

LINE 1	TABLE	ITEM CODE	WIDTH	DEPTH	WS HEIGHT	HEIGHT	LAMINATE	OPTION
		TMRCT	W96	D42	WS36	H72	M1	TV
LINE 1.1	POWER & DATA	POWER OPTION	FINISH / TRIM FINISH / COVER CODE		BODY FINISH / OPTION	POWER QTY		
		AF2RE	SLV		D	1		

**Features & Specifications**

No Charge Options  
Optional Extra

- Laminate codes - M1: 1" LPL, H1: 1" HPL, K1: 1.25" knife edge (top only)
- All laminates except for worksurface are 3/4" LPL
- Wire management through the back panel and front base
- Worksurface Height is 36" nominal, including levellers
- 120" Width worksurfaces will be in 2 sections and have seam & include 2 bases
- Available in all standard laminates
- For back panel TV/Monitor mount, add code 'TV' and \$325

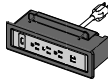
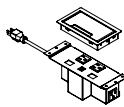
POWER & DATA	For detailed specification, cover code finishes, data and telecom options, and pricing of each electrical modules please refer to page "Power & Data Options".				
<b>AF2RE</b> 	<b>Finish:</b> Black (BLK), Silver (SLV), White (WHT), Anodized Aluminum (BAA), Stainless Steel (BSS)	<b>AF3AE</b> 	<b>Trim Finish:</b> Black (BLK), Silver (SLV), White (WHT)	<b>AU2FE</b> 	<b>Cover Code:</b> F-AL, F-S, F-B, F-W
	<b>Option (Data &amp; Telecom):</b> A, B, C, D, E, F, G, H, J, K		<b>Body Finish:</b> White (WHT), Gray (GRY), Black (BLK), Orange (ORN), Red (RED), Green (GRN), Blue (BLU)		<b>Option (Data &amp; Telecom):</b> C, K

# Rectangle Media Table, Bar Height

TMRBT

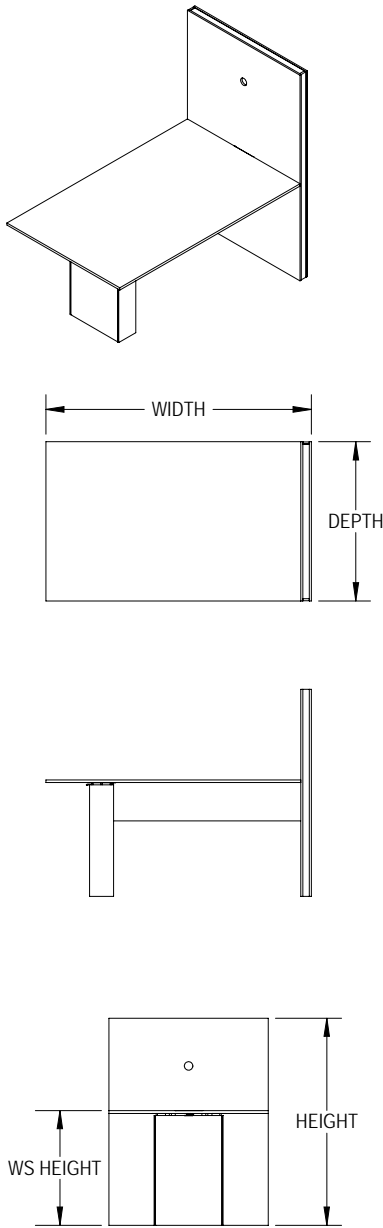

NOMINAL SIZE				POWER	LAMINATE		
WIDTH	DEPTH	WS HEIGHT	HEIGHT	QUANTITY	PRICE M1	PRICE H1	PRICE K1
60"	48"	42"	72"	1	\$2,897	\$3,322	\$4,100
72"	48"	42"	72"	1, 2	\$3,049	\$3,496	\$4,316
84"	48"	42"	72"	1, 2	\$3,059	\$3,506	\$4,331
96"	48"	42"	72"	1, 2	\$3,068	\$3,517	\$4,343
120"	48"	42"	72"	1, 2	\$3,375	\$3,869	\$4,778
60"	48"	42"	72"	1	\$3,020	\$3,445	\$4,227
72"	60"	42"	72"	1, 2	\$3,179	\$3,626	\$4,449
84"	60"	42"	72"	1, 2	\$3,188	\$3,636	\$4,464
96"	60"	42"	72"	1, 2	\$3,197	\$3,644	\$4,476
120"	60"	42"	72"	1, 2	\$3,517	\$4,008	\$4,925
60"	48"	42"	78"	1	\$2,898	\$3,322	\$4,100
72"	48"	42"	78"	1, 2	\$3,050	\$3,496	\$4,316
84"	48"	42"	78"	1, 2	\$3,059	\$3,506	\$4,333
96"	48"	42"	78"	1, 2	\$3,069	\$3,517	\$4,344
120"	48"	42"	78"	1, 2	\$3,376	\$3,869	\$4,779
60"	48"	42"	78"	1	\$3,020	\$3,446	\$4,228
72"	60"	42"	78"	1, 2	\$3,179	\$3,628	\$4,450
84"	60"	42"	78"	1, 2	\$3,188	\$3,636	\$4,464
96"	60"	42"	78"	1, 2	\$3,197	\$3,646	\$4,476
120"	60"	42"	78"	1, 2	\$3,517	\$4,011	\$4,925

**ORDER CODE SAMPLE**

LINE 1	TABLE	ITEM CODE	WIDTH	DEPTH	WS HEIGHT	HEIGHT	LAMINATE	OPTION
		TMRBT	W96	D42	WS36	H72	M1	TV
LINE 1.1	POWER & DATA	POWER OPTION	FINISH / TRIM FINISH / COVER CODE		BODY FINISH / OPTION	POWER QTY		
		AF2RE	SLV		D	1		

**Features & Specifications**

No Charge Options  
Optional Extra

- Laminate codes - M1: 1" LPL, H1: 1" HPL, K1: 1.25" knife edge (top only)
- All laminates except for worksurface are 3/4" LPL
- Wire management through the back panel and front base
- Worksurface Height is 42" nominal, including levellers
- 120" Width worksurfaces will be in 2 sections and have seam & include 2 bases
- Available in all standard laminates
- For back panel TV/Monitor mount, add code 'TV' and \$325

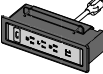
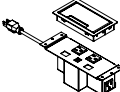
POWER & DATA	For detailed specification, cover code finishes, data and telecom options, and pricing of each electrical modules please refer to page "Power & Data Options".				
<b>AF2RE</b> 	<b>Finish:</b> Black (BLK), Silver (SLV), White (WHT), Anodized Aluminum (BAA), Stainless Steel (BSS)	<b>AF3AE</b> 	<b>Trim Finish:</b> Black (BLK), Silver (SLV), White (WHT)	<b>AU2FE</b> 	<b>Cover Code:</b> F-AL, F-S, F-B, F-W
	<b>Option (Data &amp; Telecom):</b> A, B, C, D, E, F, G, H, J, K		<b>Body Finish:</b> White (WHT), Gray (GRY), Black (BLK), Orange (ORN), Red (RED), Green (GRN), Blue (BLU)		<b>Option (Data &amp; Telecom):</b> C, K

# Bullet End Media Table, Seated Height

TMBET

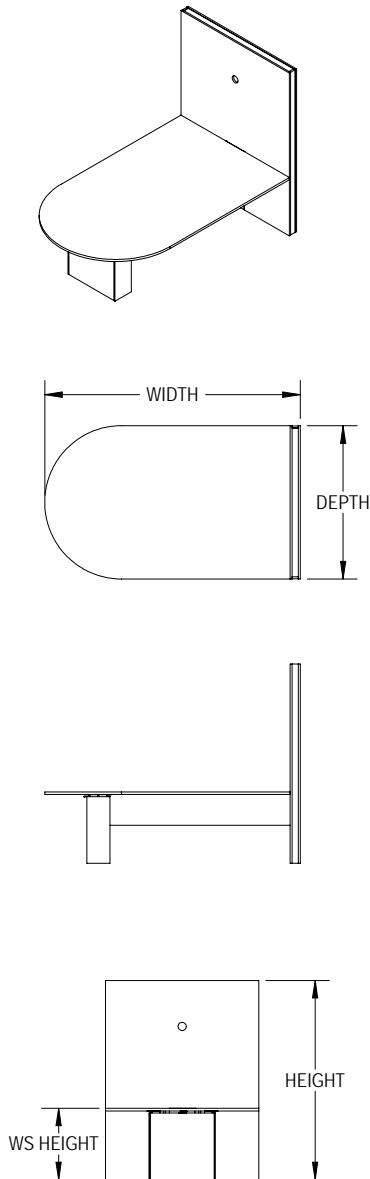

NOMINAL SIZE				POWER	LAMINATE		
WIDTH	DEPTH	WS HEIGHT	HEIGHT	QUANTITY	PRICE M1	PRICE H1	PRICE K1
60"	48"	29"	66"	1	\$2,190	\$2,510	\$3,100
72"	48"	29"	66"	1, 2	\$2,305	\$2,642	\$3,263
84"	48"	29"	66"	1, 2	\$2,313	\$2,650	\$3,274
96"	48"	29"	66"	1, 2	\$2,319	\$2,658	\$3,283
120"	48"	29"	66"	1, 2	\$2,551	\$2,924	\$3,612
60"	60"	29"	66"	1	\$2,283	\$2,604	\$3,195
72"	60"	29"	66"	1, 2	\$2,403	\$2,741	\$3,363
84"	60"	29"	66"	1, 2	\$2,409	\$2,747	\$3,373
96"	60"	29"	66"	1, 2	\$2,417	\$2,754	\$3,383
120"	60"	29"	66"	1, 2	\$2,659	\$3,030	\$3,722
60"	48"	29"	72"	1	\$2,190	\$2,511	\$3,100
72"	48"	29"	72"	1, 2	\$2,305	\$2,643	\$3,263
84"	48"	29"	72"	1, 2	\$2,313	\$2,650	\$3,274
96"	48"	29"	72"	1, 2	\$2,319	\$2,659	\$3,283
120"	48"	29"	72"	1, 2	\$2,551	\$2,925	\$3,612
60"	48"	29"	72"	1	\$2,283	\$2,604	\$3,195
72"	60"	29"	72"	1, 2	\$2,403	\$2,741	\$3,363
84"	60"	29"	72"	1, 2	\$2,410	\$2,748	\$3,374
96"	60"	29"	72"	1, 2	\$2,417	\$2,754	\$3,384
120"	60"	29"	72"	1, 2	\$2,659	\$3,030	\$3,723
60"	48"	29"	78"	1	\$2,191	\$2,511	\$3,100
72"	48"	29"	78"	1, 2	\$2,306	\$2,643	\$3,263
84"	48"	29"	78"	1, 2	\$2,313	\$2,650	\$3,275
96"	48"	29"	78"	1, 2	\$2,320	\$2,659	\$3,284
120"	48"	29"	78"	1, 2	\$2,552	\$2,925	\$3,613
60"	48"	29"	78"	1	\$2,283	\$2,605	\$3,196
72"	60"	29"	78"	1, 2	\$2,403	\$2,742	\$3,364
84"	60"	29"	78"	1, 2	\$2,410	\$2,748	\$3,374
96"	60"	29"	78"	1, 2	\$2,417	\$2,756	\$3,384
120"	60"	29"	78"	1, 2	\$2,659	\$3,032	\$3,723

**ORDER CODE SAMPLE**

LINE 1	TABLE	ITEM CODE	WIDTH	DEPTH	WS HEIGHT	HEIGHT	LAMINATE	OPTION
		TMBET	W96	D42	WS29	H72	M1	TV
LINE 1.1	POWER & DATA	POWER OPTION	FINISH / TRIM FINISH / COVER CODE		BODY FINISH / OPTION	POWER QTY		
		AF2RE	SLV		D	1		

**Features & Specifications**

No Charge Options  
Optional Extra

- Laminate codes - M1: 1" LPL, H1: 1" HPL, K1: 1.25" knife edge (top only)
- All laminates except for worksurface are 3/4" LPL
- Wire management through the back panel and front base
- Worksurface Height is 29" nominal, including levellers
- 120" Width worksurfaces will be in 2 sections and have seam & include 2 bases
- Available in all standard laminates
- For back panel TV/Monitor mount, add code 'TV' and \$325

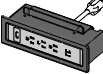
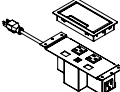
POWER & DATA	For detailed specification, cover code finishes, data and telecom options, and pricing of each electrical modules please refer to page "Power & Data Options".				
<b>AF2RE</b> 	<b>Finish:</b> Black (BLK), Silver (SLV), White (WHT), Anodized Aluminum (BAA), Stainless Steel (BSS)  <b>Option (Data &amp; Telecom):</b> A, B, C, D, E, F, G, H, J, K	<b>AF3AE</b> 	<b>Trim Finish:</b> Black (BLK), Silver (SLV), White (WHT)  <b>Body Finish:</b> White (WHT), Gray (GRY), Black (BLK), Orange (ORN), Red (RED), Green (GRN), Blue (BLU)	<b>AU2FE</b> 	<b>Cover Code:</b> F-AL, F-S, F-B, F-W  <b>Option (Data &amp; Telecom):</b> C, K

PRODUCT MAP  
CONFERENCE TABLES  
MEDIA TABLES  
PARSONS TABLES  
MEETING & CASUAL TABLES  
NEST TRAINING TABLES  
www.brc.group

# Bullet End Media Table, Counter Height

TMBCT

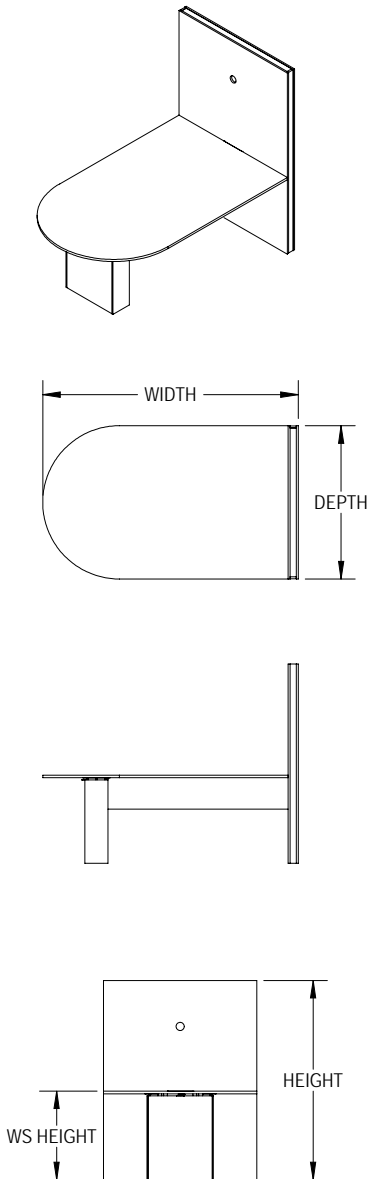

NOMINAL SIZE				POWER	LAMINATE		
WIDTH	DEPTH	WS HEIGHT	HEIGHT	QUANTITY	PRICE M1	PRICE H1	PRICE K1
60"	48"	36"	66"	1	\$2,519	\$2,887	\$3,565
72"	48"	36"	66"	1, 2	\$2,651	\$3,039	\$3,753
84"	48"	36"	66"	1, 2	\$2,660	\$3,048	\$3,766
96"	48"	36"	66"	1, 2	\$2,667	\$3,057	\$3,776
120"	48"	36"	66"	1, 2	\$2,934	\$3,363	\$4,154
60"	60"	36"	66"	1	\$2,626	\$2,995	\$3,675
72"	60"	36"	66"	1, 2	\$2,764	\$3,153	\$3,868
84"	60"	36"	66"	1, 2	\$2,771	\$3,160	\$3,879
96"	60"	36"	66"	1, 2	\$2,780	\$3,168	\$3,891
120"	60"	36"	66"	1, 2	\$3,058	\$3,485	\$4,281
60"	48"	36"	72"	1	\$2,519	\$2,888	\$3,565
72"	48"	36"	72"	1, 2	\$2,651	\$3,040	\$3,753
84"	48"	36"	72"	1, 2	\$2,660	\$3,048	\$3,766
96"	48"	36"	72"	1, 2	\$2,667	\$3,058	\$3,776
120"	48"	36"	72"	1, 2	\$2,934	\$3,364	\$4,154
60"	48"	36"	72"	1	\$2,626	\$2,995	\$3,675
72"	60"	36"	72"	1, 2	\$2,764	\$3,153	\$3,868
84"	60"	36"	72"	1, 2	\$2,772	\$3,161	\$3,881
96"	60"	36"	72"	1, 2	\$2,780	\$3,168	\$3,892
120"	60"	36"	72"	1, 2	\$3,058	\$3,485	\$4,282
60"	48"	36"	78"	1	\$2,520	\$2,888	\$3,565
72"	48"	36"	78"	1, 2	\$2,652	\$3,040	\$3,753
84"	48"	36"	78"	1, 2	\$2,660	\$3,048	\$3,767
96"	48"	36"	78"	1, 2	\$2,668	\$3,058	\$3,777
120"	48"	36"	78"	1, 2	\$2,935	\$3,364	\$4,155
60"	48"	36"	78"	1	\$2,626	\$2,996	\$3,676
72"	60"	36"	78"	1, 2	\$2,764	\$3,154	\$3,869
84"	60"	36"	78"	1, 2	\$2,772	\$3,161	\$3,881
96"	60"	36"	78"	1, 2	\$2,780	\$3,170	\$3,892
120"	60"	36"	78"	1, 2	\$3,058	\$3,487	\$4,282

**ORDER CODE SAMPLE**

LINE 1	TABLE	ITEM CODE	WIDTH	DEPTH	WS HEIGHT	HEIGHT	LAMINATE	OPTION
		TMBCT	W96	D42	WS36	H72	M1	TV
LINE 1.1	POWER & DATA	POWER OPTION	FINISH / TRIM FINISH / COVER CODE		BODY FINISH / OPTION	POWER QTY		
		AF2RE	SLV		D	1		

**Features & Specifications**

No Charge Options  
Optional Extra

- Laminate codes - M1: 1" LPL, H1: 1" HPL, K1: 1.25" knife edge (top only)
- All laminates except for worksurface are 3/4" LPL
- Wire management through the back panel and front base
- Worksurface Height is 36" nominal, including levellers
- 120" Width worksurfaces will be in 2 sections and have seam & include 2 bases
- Available in all standard laminates
- For back panel TV/Monitor mount, add code 'TV' and \$325

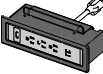
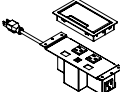
POWER & DATA	For detailed specification, cover code finishes, data and telecom options, and pricing of each electrical modules please refer to page "Power & Data Options".			
<b>AF2RE</b>  <b>Finish:</b> Black (BLK), Silver (SLV), White (WHT), Anodized Aluminum (BAA), Stainless Steel (BSS) <b>Option (Data &amp; Telecom):</b> A, B, C, D, E, F, G, H, J, K	<b>AF3AE</b>  <b>Trim Finish:</b> Black (BLK), Silver (SLV), White (WHT) <b>Body Finish:</b> White (WHT), Gray (GRY), Black (BLK), Orange (ORN), Red (RED), Green (GRN), Blue (BLU)	<b>AU2FE</b>  <b>Cover Code:</b> F-AL, F-S, F-B, F-W <b>Option (Data &amp; Telecom):</b> C, K		

# Bullet End Media Table, Bar Height

TMBBT

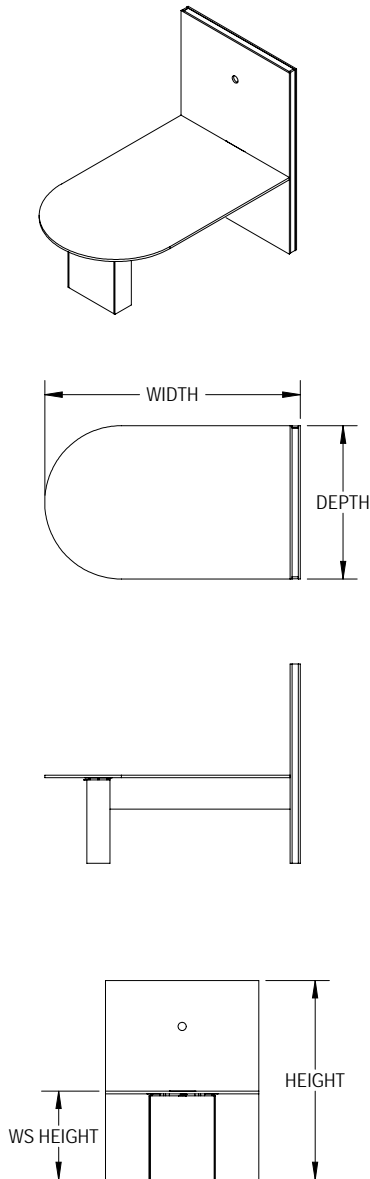

NOMINAL SIZE				POWER	LAMINATE		
WIDTH	DEPTH	WS HEIGHT	HEIGHT	QUANTITY	PRICE M1	PRICE H1	PRICE K1
60"	48"	42"	72"	1	\$2,897	\$3,322	\$4,100
72"	48"	42"	72"	1, 2	\$3,049	\$3,496	\$4,316
84"	48"	42"	72"	1, 2	\$3,059	\$3,506	\$4,331
96"	48"	42"	72"	1, 2	\$3,068	\$3,517	\$4,343
120"	48"	42"	72"	1, 2	\$3,375	\$3,869	\$4,778
60"	48"	42"	72"	1	\$3,020	\$3,445	\$4,227
72"	60"	42"	72"	1, 2	\$3,179	\$3,626	\$4,449
84"	60"	42"	72"	1, 2	\$3,188	\$3,636	\$4,464
96"	60"	42"	72"	1, 2	\$3,197	\$3,644	\$4,476
120"	60"	42"	72"	1, 2	\$3,517	\$4,008	\$4,925
60"	48"	42"	78"	1	\$2,898	\$3,322	\$4,100
72"	48"	42"	78"	1, 2	\$3,050	\$3,496	\$4,316
84"	48"	42"	78"	1, 2	\$3,059	\$3,506	\$4,333
96"	48"	42"	78"	1, 2	\$3,069	\$3,517	\$4,344
120"	48"	42"	78"	1, 2	\$3,376	\$3,869	\$4,779
60"	48"	42"	78"	1	\$3,020	\$3,446	\$4,228
72"	60"	42"	78"	1, 2	\$3,179	\$3,628	\$4,450
84"	60"	42"	78"	1, 2	\$3,188	\$3,636	\$4,464
96"	60"	42"	78"	1, 2	\$3,197	\$3,646	\$4,476
120"	60"	42"	78"	1, 2	\$3,517	\$4,011	\$4,925

**ORDER CODE SAMPLE**

LINE 1	TABLE	ITEM CODE	WIDTH	DEPTH	WS HEIGHT	HEIGHT	LAMINATE	OPTION
		TMBBT	W96	D42	WS42	H72	M1	TV
LINE 1.1	POWER & DATA	POWER OPTION	FINISH / TRIM FINISH / COVER CODE		BODY FINISH / OPTION	POWER QTY		
		AF2RE	SLV		D	1		

**Features & Specifications**

No Charge Options  
Optional Extra

- Laminate codes - M1: 1" LPL, H1: 1" HPL, K1: 1.25" knife edge (top only)
- All laminates except for worksurface are 3/4" LPL
- Wire management through the back panel and front base
- Worksurface Height is 42" nominal, including levellers
- 120" Width worksurfaces will be in 2 sections and have seam & include 2 bases
- Available in all standard laminates
- For back panel TV/Monitor mount, add code 'TV' and \$325

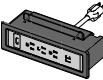
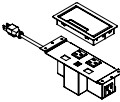
POWER & DATA	For detailed specification, cover code finishes, data and telecom options, and pricing of each electrical modules please refer to page "Power & Data Options".				
<b>AF2RE</b> 	<b>Finish:</b> Black (BLK), Silver (SLV), White (WHT), Anodized Aluminum (BAA), Stainless Steel (BSS)	<b>AF3AE</b> 	<b>Trim Finish:</b> Black (BLK), Silver (SLV), White (WHT)	<b>AU2FE</b> 	<b>Cover Code:</b> F-AL, F-S, F-B, F-W
	<b>Option (Data &amp; Telecom):</b> A, B, C, D, E, F, G, H, J, K		<b>Body Finish:</b> White (WHT), Gray (GRY), Black (BLK), Orange (ORN), Red (RED), Green (GRN), Blue (BLU)		<b>Option (Data &amp; Telecom):</b> C, K

# Trapezoid Media Table, Seated Height

TMTZT

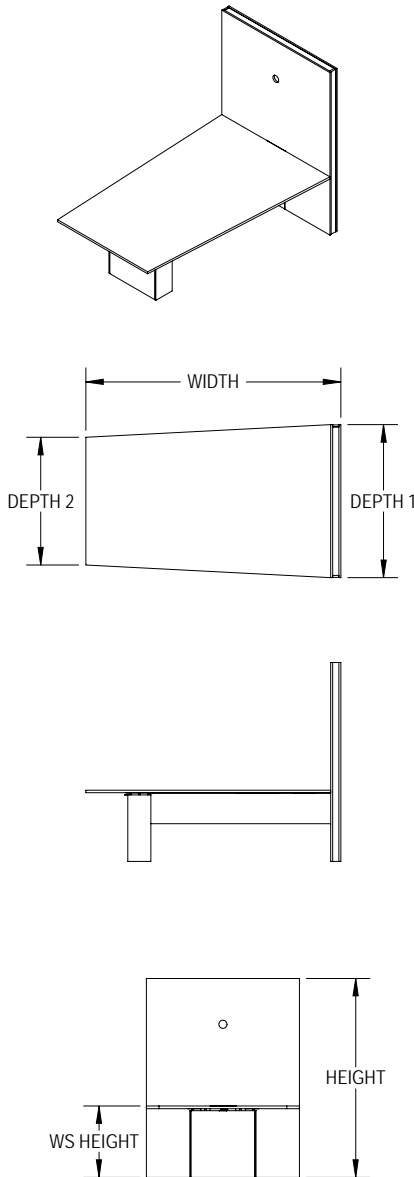

NOMINAL SIZE					POWER	LAMINATE		
WIDTH	DEPTH 1	DEPTH 2	WS HEIGHT	HEIGHT	QTY	PRICE M1	PRICE H1	PRICE K1
60"	48"	25"	29"	66"	1	\$2,190	\$2,510	\$3,100
72"	48"	25"	29"	66"	1, 2	\$2,305	\$2,642	\$3,263
84"	48"	25"	29"	66"	1, 2	\$2,313	\$2,650	\$3,274
96"	48"	25"	29"	66"	1, 2	\$2,319	\$2,658	\$3,283
120"	48"	25"	29"	66"	1, 2	\$2,667	\$3,057	\$3,776
60"	60"	48"	29"	66"	1	\$2,283	\$2,604	\$3,195
72"	60"	48"	29"	66"	1, 2	\$2,403	\$2,741	\$3,363
84"	60"	48"	29"	66"	1, 2	\$2,409	\$2,747	\$3,373
96"	60"	48"	29"	66"	1, 2	\$2,417	\$2,754	\$3,383
120"	60"	48"	29"	66"	1, 2	\$2,780	\$3,168	\$3,891
60"	48"	25"	29"	72"	1	\$2,190	\$2,511	\$3,100
72"	48"	25"	29"	72"	1, 2	\$2,305	\$2,643	\$3,263
84"	48"	25"	29"	72"	1, 2	\$2,313	\$2,650	\$3,274
96"	48"	25"	29"	72"	1, 2	\$2,319	\$2,659	\$3,283
120"	48"	25"	29"	72"	1, 2	\$2,667	\$3,058	\$3,776
60"	60"	48"	29"	72"	1	\$2,283	\$2,604	\$3,195
72"	60"	48"	29"	72"	1, 2	\$2,403	\$2,741	\$3,363
84"	60"	48"	29"	72"	1, 2	\$2,410	\$2,748	\$3,374
96"	60"	48"	29"	72"	1, 2	\$2,417	\$2,754	\$3,384
120"	60"	48"	29"	72"	1, 2	\$2,780	\$3,168	\$3,892
60"	48"	25"	29"	72"	1	\$2,191	\$2,511	\$3,100
72"	48"	25"	29"	78"	1, 2	\$2,306	\$2,643	\$3,263
84"	48"	25"	29"	78"	1, 2	\$2,313	\$2,650	\$3,275
96"	48"	25"	29"	78"	1, 2	\$2,320	\$2,659	\$3,284
120"	48"	25"	29"	78"	1, 2	\$2,668	\$3,058	\$3,777
60"	60"	48"	29"	78"	1	\$2,283	\$2,605	\$3,196
72"	60"	48"	29"	78"	1, 2	\$2,403	\$2,742	\$3,364
84"	60"	48"	29"	78"	1, 2	\$2,410	\$2,748	\$3,374
96"	60"	48"	29"	78"	1, 2	\$2,417	\$2,756	\$3,384
120"	60"	48"	29"	78"	1, 2	\$2,780	\$3,170	\$3,892

**ORDER CODE SAMPLE**

LINE 1	TABLE	ITEM CODE	WIDTH	DEPTH 1	DEPTH 2	WS HEIGHT	HEIGHT	LAMINATE	OPTION
		TMTZT	W96	D54	D44	WS29	H72	M1	TV
LINE 1.1	POWER & DATA	POWER OPTION	FINISH / TRIM FINISH / COVER CODE		BODY FINISH / OPTION		POWER QTY		
		AF2RE	SLV		D		1		

**Features & Specifications**

No Charge Options  
Optional Extra

- Laminate codes - M1: 1" LPL, H1: 1" HPL, K1: 1.25" knife edge (top only)
- All laminates except for worksurface are 3/4" LPL
- Wire management through the back panel and front base
- Worksurface Height is 29" nominal, including levellers
- 120" Width worksurfaces will be in 2 sections and have seam & include 2 bases
- Available in all standard laminates
- For back panel TV/Monitor mount, add code 'TV' and \$325

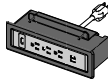
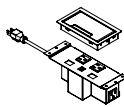
POWER & DATA	For detailed specification, cover code finishes, data and telecom options, and pricing of each electrical modules please refer to page "Power & Data Options".				
<b>AF2RE</b> 	<b>Finish:</b> Black (BLK), Silver (SLV), White (WHT), Anodized Aluminum (BAA), Stainless Steel (BSS)	<b>AF3AE</b> 	<b>Trim Finish:</b> Black (BLK), Silver (SLV), White (WHT)	<b>AU2FE</b> 	<b>Cover Code:</b> F-AL, F-S, F-B, F-W
	<b>Option (Data &amp; Telecom):</b> A, B, C, D, E, F, G, H, J, K		<b>Body Finish:</b> White (WHT), Gray (GRY), Black (BLK), Orange (ORN), Red (RED), Green (GRN), Blue (BLU)		<b>Option (Data &amp; Telecom):</b> C, K

PRODUCT MAP  
CONFERENCE TABLES  
MEDIA TABLES  
PARSONS TABLES  
MEETING & CASUAL TABLES  
NEST TRAINING TABLES  
www.brc.group

# Trapezoid Media Table, Counter Height

TMTCT

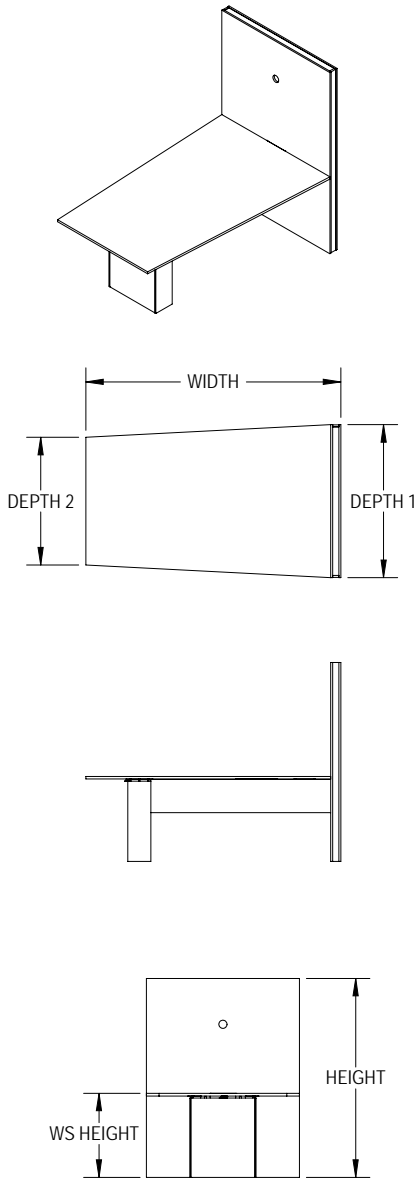

NOMINAL SIZE					POWER	LAMINATE		
WIDTH	DEPTH 1	DEPTH 2	WS HEIGHT	HEIGHT	QTY	PRICE M1	PRICE H1	PRICE K1
60"	48"	25"	36"	66"	1	\$2,409	\$2,761	\$3,411
72"	48"	25"	36"	66"	1, 2	\$2,536	\$2,907	\$3,590
84"	48"	25"	36"	66"	1, 2	\$2,545	\$2,916	\$3,602
96"	48"	25"	36"	66"	1, 2	\$2,551	\$2,924	\$3,612
120"	48"	25"	36"	66"	1, 2	\$2,934	\$3,363	\$4,154
60"	60"	48"	36"	66"	1	\$2,512	\$2,865	\$3,515
72"	60"	48"	36"	66"	1, 2	\$2,644	\$3,016	\$3,700
84"	60"	48"	36"	66"	1, 2	\$2,650	\$3,022	\$3,711
96"	60"	48"	36"	66"	1, 2	\$2,659	\$3,030	\$3,722
120"	60"	48"	36"	66"	1, 2	\$3,059	\$3,485	\$4,281
60"	48"	25"	36"	72"	1	\$2,409	\$2,763	\$3,411
72"	48"	25"	36"	72"	1, 2	\$2,536	\$2,908	\$3,590
84"	48"	25"	36"	72"	1, 2	\$2,545	\$2,916	\$3,602
96"	48"	25"	36"	72"	1, 2	\$2,551	\$2,925	\$3,612
120"	48"	25"	36"	72"	1, 2	\$2,934	\$3,364	\$4,154
60"	60"	48"	36"	72"	1	\$2,512	\$2,865	\$3,515
72"	60"	48"	36"	72"	1, 2	\$2,644	\$3,016	\$3,700
84"	60"	48"	36"	72"	1, 2	\$2,651	\$3,023	\$3,712
96"	60"	48"	36"	72"	1, 2	\$2,659	\$3,030	\$3,723
120"	60"	48"	36"	72"	1, 2	\$3,059	\$3,485	\$4,282
60"	48"	25"	36"	72"	1	\$2,411	\$2,763	\$3,411
72"	48"	25"	36"	78"	1, 2	\$2,537	\$2,908	\$3,590
84"	48"	25"	36"	78"	1, 2	\$2,545	\$2,916	\$3,603
96"	48"	25"	36"	78"	1, 2	\$2,552	\$2,925	\$3,613
120"	48"	25"	36"	78"	1, 2	\$2,935	\$3,364	\$4,155
60"	60"	48"	36"	78"	1	\$2,512	\$2,866	\$3,516
72"	60"	48"	36"	78"	1, 2	\$2,644	\$3,017	\$3,701
84"	60"	48"	36"	78"	1, 2	\$2,651	\$3,023	\$3,712
96"	60"	48"	36"	78"	1, 2	\$2,659	\$3,032	\$3,723
120"	60"	48"	36"	78"	1, 2	\$3,059	\$3,488	\$4,282

**ORDER CODE SAMPLE**

LINE 1	TABLE	ITEM CODE	WIDTH	DEPTH 1	DEPTH 2	WS HEIGHT	HEIGHT	LAMINATE	OPTION
		TMTCT	W96	D54	D44	WS36	H72	M1	TV
LINE 1.1	POWER & DATA	POWER OPTION	FINISH / TRIM FINISH / COVER CODE		BODY FINISH / OPTION	POWER QTY			
		AF2RE	SLV		D	1			

**Features & Specifications**

No Charge Options  
Optional Extra

- Laminate codes - M1: 1" LPL, H1: 1" HPL, K1: 1.25" knife edge (top only)
- All laminates except for worksurface are 3/4" LPL
- Wire management through the back panel and front base
- Worksurface Height is 36" nominal, including levellers
- 120" Width worksurfaces will be in 2 sections and have seam & include 2 bases
- Available in all standard laminates
- For back panel TV/Monitor mount, add code 'TV' and \$325

<b>POWER &amp; DATA</b>	For detailed specification, cover code finishes, data and telecom options, and pricing of each electrical modules please refer to page "Power & Data Options".			
<b>AF2RE</b> 	<b>Finish:</b> Black (BLK), Silver (SLV), White (WHT), Anodized Aluminum (BAA), Stainless Steel (BSS)  <b>Option (Data &amp; Telecom):</b> A, B, C, D, E, F, G, H, J, K	<b>AF3AE</b> 	<b>Trim Finish:</b> Black (BLK), Silver (SLV), White (WHT)  <b>Body Finish:</b> White (WHT), Gray (GRY), Black (BLK), Orange (ORN), Red (RED), Green (GRN), Blue (BLU)	<b>AU2FE</b> 
				<b>Cover Code:</b> F-AL, F-S, F-B, F-W  <b>Option (Data &amp; Telecom):</b> C, K

PRODUCT MAP  
CONFERENCE TABLES  
MEDIA TABLES  
PARSONS TABLES  
MEETING & CASUAL TABLES  
NEST TRAINING TABLES  
www.brc.group

# Trapezoid Media Table, Bar Height

TMTBT

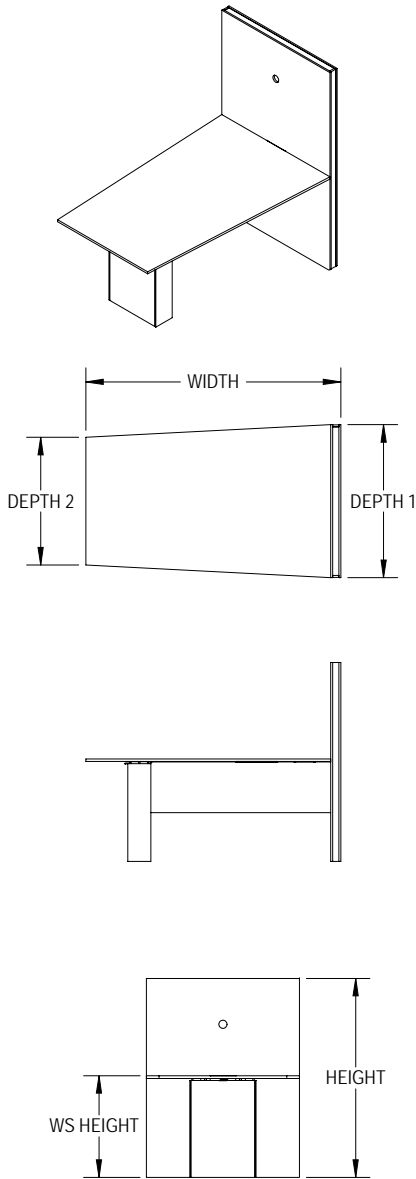

NOMINAL SIZE					POWER QTY	LAMINATE		
WIDTH	DEPTH 1	DEPTH 2	WS HEIGHT	HEIGHT		PRICE M1	PRICE H1	PRICE K1
60"	48"	25"	42"	72"	1	\$2,409	\$2,763	\$3,411
72"	48"	25"	42"	72"	1, 2	\$2,536	\$2,908	\$3,590
84"	48"	25"	42"	72"	1, 2	\$2,545	\$2,916	\$3,602
96"	48"	25"	42"	72"	1, 2	\$2,551	\$2,925	\$3,612
120"	48"	25"	42"	72"	1, 2	\$2,934	\$3,364	\$4,154
60"	60"	48"	42"	72"	1	\$2,512	\$2,865	\$3,515
72"	60"	48"	42"	72"	1, 2	\$2,644	\$3,016	\$3,700
84"	60"	48"	42"	72"	1, 2	\$2,651	\$3,023	\$3,712
96"	60"	48"	42"	72"	1, 2	\$2,659	\$3,030	\$3,723
120"	60"	48"	42"	72"	1, 2	\$3,059	\$3,485	\$4,282
60"	48"	25"	42"	72"	1	\$2,411	\$2,763	\$3,411
72"	48"	25"	42"	78"	1, 2	\$2,537	\$2,908	\$3,590
84"	48"	25"	42"	78"	1, 2	\$2,545	\$2,916	\$3,603
96"	48"	25"	42"	78"	1, 2	\$2,552	\$2,925	\$3,613
120"	48"	25"	42"	78"	1, 2	\$2,935	\$3,364	\$4,155
60"	60"	48"	42"	78"	1	\$2,512	\$2,866	\$3,516
72"	60"	48"	42"	78"	1, 2	\$2,644	\$3,017	\$3,701
84"	60"	48"	42"	78"	1, 2	\$2,651	\$3,023	\$3,712
96"	60"	48"	42"	78"	1, 2	\$2,659	\$3,032	\$3,723
120"	60"	48"	42"	78"	1, 2	\$3,059	\$3,488	\$4,282

**ORDER CODE SAMPLE**

LINE 1	TABLE	ITEM CODE	WIDTH	DEPTH 1	DEPTH 2	WS HEIGHT	HEIGHT	LAMINATE	OPTION
		TMTBT	W96	D54	D44	WS42	H72	M1	TV
LINE 1.1	POWER & DATA	POWER OPTION	FINISH / TRIM FINISH / COVER CODE		BODY FINISH / OPTION	POWER QTY			
		AF2RE	SLV		D	1			

**Features & Specifications**

No Charge Options  
Optional Extra

- Laminate codes - M1: 1" LPL, H1: 1" HPL, K1: 1.25" knife edge (top only)
- All laminates except for worksurface are 3/4" LPL
- Wire management through the back panel and front base
- Worksurface Height is 42" nominal, including levellers
- 120" Width worksurfaces will be in 2 sections and have seam & include 2 bases
- Available in all standard laminates
- For back panel TV/Monitor mount, add code 'TV' and \$325

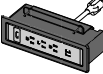
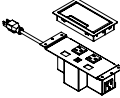
POWER & DATA	For detailed specification, cover code finishes, data and telecom options, and pricing of each electrical modules please refer to page "Power & Data Options".				
<b>AF2RE</b> 	<b>Finish:</b> Black (BLK), Silver (SLV), White (WHT), Anodized Aluminum (BAA), Stainless Steel (BSS)	<b>AF3AE</b> 	<b>Trim Finish:</b> Black (BLK), Silver (SLV), White (WHT)	<b>AU2FE</b> 	<b>Cover Code:</b> F-AL, F-S, F-B, F-W
	<b>Option (Data &amp; Telecom):</b> A, B, C, D, E, F, G, H, J, K		<b>Body Finish:</b> White (WHT), Gray (GRY), Black (BLK), Orange (ORN), Red (RED), Green (GRN), Blue (BLU)		<b>Option (Data &amp; Telecom):</b> C, K

# Parsons Table



Great touchdown areas start with great furniture and BRC delivers with its Parsons Table. Available in all BRC standard laminates including our antibacterial options that are perfect for communal spaces. Unique under mount power options provide a clean worksurface for users while providing data and electrics needed for today's electronics. Integrated wire management keeps it looking clean and organized.

# Power Options: Parsons Tables

**AU2AE: 210 Undermount**

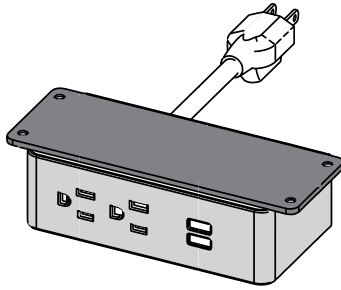

AU2AE	
FEATURES & SPECIFICATIONS	PRICE
<ul style="list-style-type: none"> <li>• Double outlet</li> <li>• Two USB ports</li> <li>• 72" Corded plug</li> <li>• Finish options: Trim: black, silver or white Body: white, grey, black, orange, red, green, blue</li> </ul>	573

**AF2AE: Duo Flush Mount**

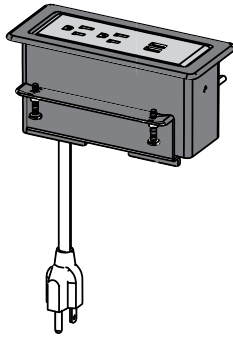

AF2AE	
FEATURES & SPECIFICATIONS	PRICE
<ul style="list-style-type: none"> <li>• Double outlet</li> <li>• Two USB ports</li> <li>• 72" Corded plug</li> <li>• Finish options: Trim: black, silver or white Body: white, grey, black, orange, red, green, blue</li> </ul>	583

**AT1FE: Top Mount Tilting**

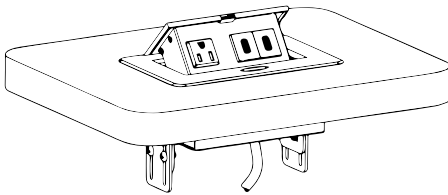

AT1FE	
FEATURES & SPECIFICATIONS	PRICE
<ul style="list-style-type: none"> <li>• Single outlet</li> <li>• 2 USB charging ports with separate power adapter</li> <li>• Push button tilting mechanism</li> <li>• 96" black power cable</li> <li>• Finish options: silver only</li> </ul>	520

**ORDER CODE SAMPLE**

LINE 1	TABLE	ITEM CODE	WIDTH	DEPTH	HEIGHT	LAMINATE
		TPART	W96	D48	H42	M1
LINE 1.1	POWER & DATA	POWER OPTION	FINISH / TRIM FINISH / COVER CODE	BODY FINISH / OPTION	POWER QTY	
		AU2AE	SLV	BLK	1	

# Wire Management: Parsons Tables

## Wire Management for AF2AE & AT1FE Power Modules

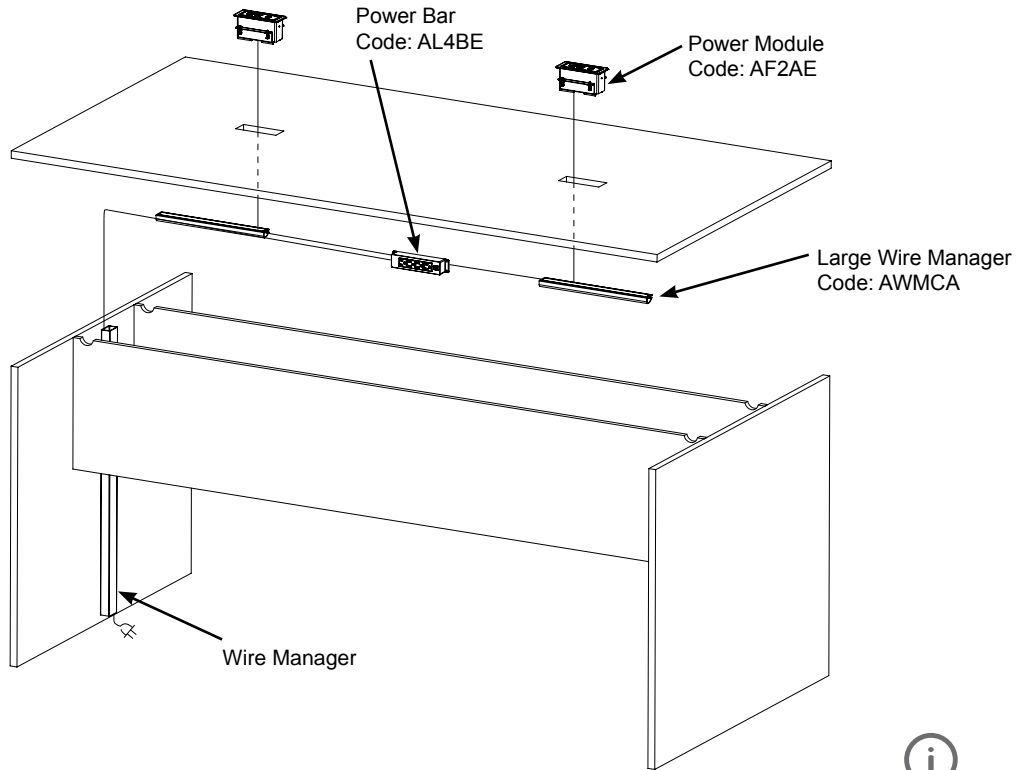

## Wire Management for AU2AE Power Module

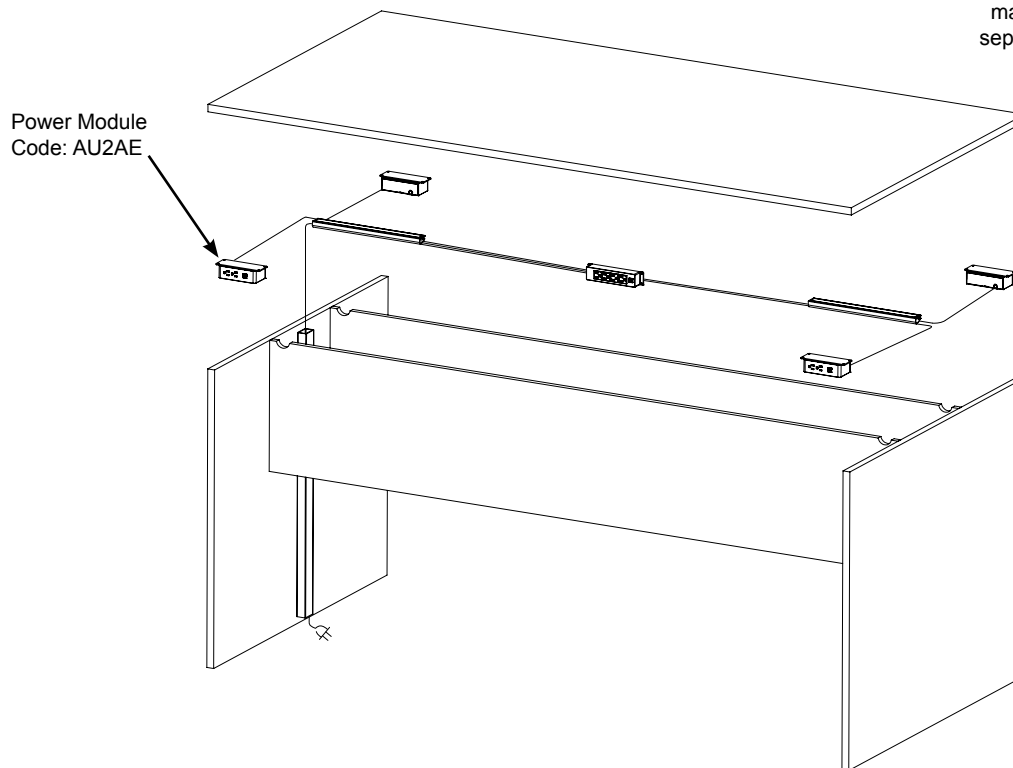

Horizontal wire managers (AWMCA) are included with power modules. Power bars and other vertical wire managers can be ordered separately from Accessories Price Guide.

# Power Location: Parsons Tables

## AF2AE & AT1FE

When power modules AF2AE and AT1FE are specified, the default location for one, two, three or four modules is shown below:

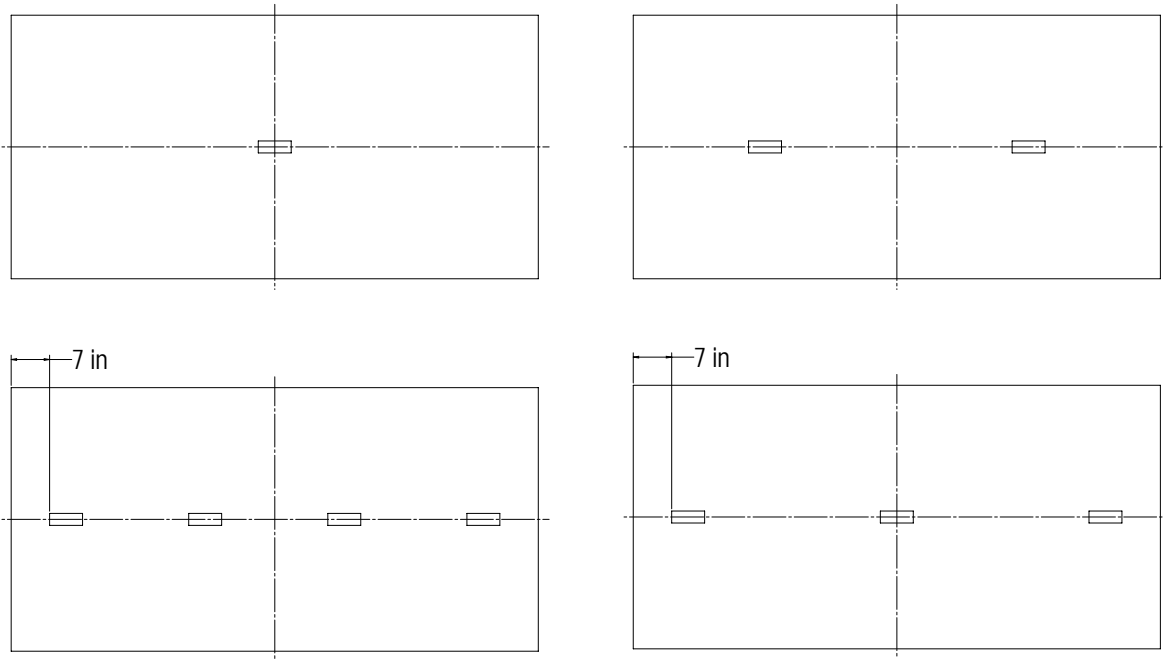

## AU2AE

When power module AU2AE is specified, the recommended location for one, two, three or four modules is shown below. These undersurface modules do not have pilot holes in the worksurface for mounting and therefore can be placed at any point under the surface as required.

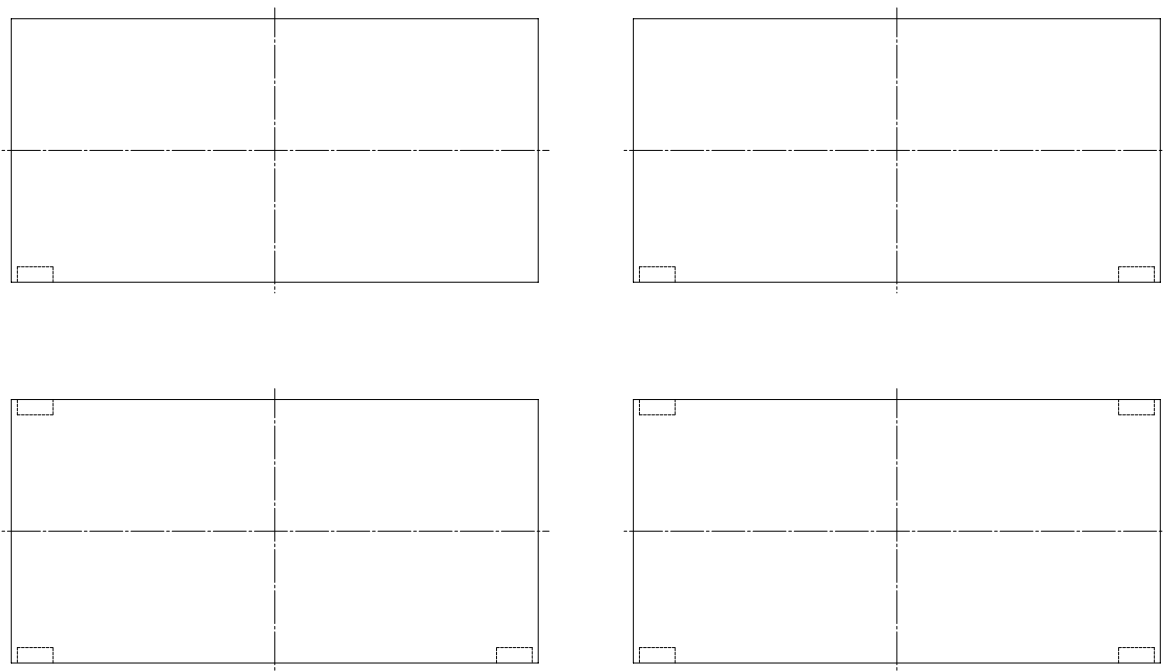

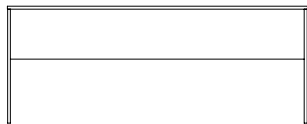
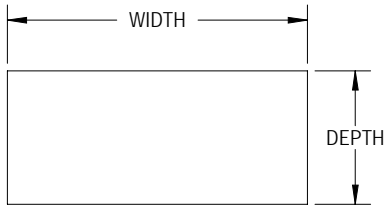
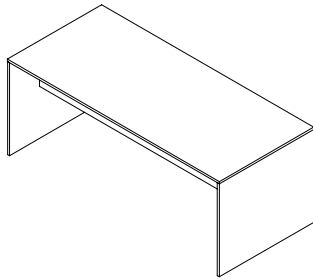

NOMINAL SIZE			POWER	LAMINATE	
WIDTH	DEPTH	HEIGHT	QUANTITY	PRICE M1	PRICE H1
48"	36"	29"	1, 2, 3, 4	\$1,073	\$1,581
60"	36"	29"	1, 2, 3, 4	\$1,097	\$1,617
72"	36"	29"	1, 2, 3, 4	\$1,124	\$1,698
84"	36"	29"	1, 2, 3, 4	\$1,257	\$1,824
96"	36"	29"	1, 2, 3, 4	\$1,288	\$1,854
48"	42"	29"	1, 2, 3, 4	\$1,081	\$1,587
60"	42"	29"	1, 2, 3, 4	\$1,105	\$1,620
72"	42"	29"	1, 2, 3, 4	\$1,130	\$1,704
84"	42"	29"	1, 2, 3, 4	\$1,261	\$1,833
96"	42"	29"	1, 2, 3, 4	\$1,295	\$1,861
48"	48"	29"	1, 2, 3, 4	\$907	\$1,326
60"	48"	29"	1, 2, 3, 4	\$1,108	\$1,624
72"	48"	29"	1, 2, 3, 4	\$1,135	\$1,711
84"	48"	29"	1, 2, 3, 4	\$1,266	\$1,839
96"	48"	29"	1, 2, 3, 4	\$1,298	\$1,868
48"	36"	36"	1, 2, 3, 4	\$1,082	\$1,590
60"	36"	36"	1, 2, 3, 4	\$1,107	\$1,622
72"	36"	36"	1, 2, 3, 4	\$1,133	\$1,704
84"	36"	36"	1, 2, 3, 4	\$1,264	\$1,833
96"	36"	36"	1, 2, 3, 4	\$1,297	\$1,861
48"	42"	36"	1, 2, 3, 4	\$1,087	\$1,594
60"	42"	36"	1, 2, 3, 4	\$1,112	\$1,629
72"	42"	36"	1, 2, 3, 4	\$1,137	\$1,713
84"	42"	36"	1, 2, 3, 4	\$1,270	\$1,841
96"	42"	36"	1, 2, 3, 4	\$1,301	\$1,870
48"	48"	36"	1, 2, 3, 4	\$917	\$1,336
60"	48"	36"	1, 2, 3, 4	\$1,117	\$1,633
72"	48"	36"	1, 2, 3, 4	\$1,144	\$1,722
84"	48"	36"	1, 2, 3, 4	\$1,275	\$1,849
96"	48"	36"	1, 2, 3, 4	\$1,308	\$1,876
48"	36"	42"	1, 2, 3, 4	\$1,087	\$1,594
60"	36"	42"	1, 2, 3, 4	\$1,112	\$1,629
72"	36"	42"	1, 2, 3, 4	\$1,137	\$1,710
84"	36"	42"	1, 2, 3, 4	\$1,270	\$1,838
96"	36"	42"	1, 2, 3, 4	\$1,301	\$1,866
48"	42"	42"	1, 2, 3, 4	\$1,094	\$1,601
60"	42"	42"	1, 2, 3, 4	\$1,118	\$1,634
72"	42"	42"	1, 2, 3, 4	\$1,144	\$1,721
84"	42"	42"	1, 2, 3, 4	\$1,276	\$1,848
96"	42"	42"	1, 2, 3, 4	\$1,309	\$1,875
48"	48"	42"	1, 2, 3, 4	\$926	\$1,344
60"	48"	42"	1, 2, 3, 4	\$1,124	\$1,643
72"	48"	42"	1, 2, 3, 4	\$1,152	\$1,730
84"	48"	42"	1, 2, 3, 4	\$1,284	\$1,858
96"	48"	42"	1, 2, 3, 4	\$1,315	\$1,885



ORDER CODE SAMPLE

LINE 1	TABLE	ITEM CODE	WIDTH	DEPTH	HEIGHT	LAMINATE
		TPART	W96	D48	H42	M1
LINE 1.1	POWER & DATA	POWER OPTION	FINISH / TRIM FINISH / COVER CODE	BODY FINISH / OPTION	POWER QTY	
		AU2AE	SLV	BLK	1	

Features & Specifications

No Charge Options

- Laminate codes - M1: 1" LPL, H1: 1" HPL (top only)
- All 1" LPL construction, except for modesties
- Includes twin modesties for wire management
- Available in all standard laminates

POWER	For detailed specification, cover code finishes, data and telecom options, and pricing of each electrical modules please refer to page "Power & Data Options".				
<b>AU2AE</b> 	<b>Trim Finish:</b> Black (BLK), Silver (SLV), White (WHT)	<b>AF2AE</b> 	<b>Trim Finish:</b> Black (BLK), Silver (SLV), White (WHT)	<b>AT1FE</b> 	<b>Finish:</b> Silver (SLV) Only
	<b>Body Finish:</b> White (WHT), Gray (GRY), Black (BLK), Orange (ORN), Red (RED), Green (GRN), Blue (BLU)		<b>Body Finish:</b> White (WHT), Gray (GRY), Black (BLK), Orange (ORN), Red (RED), Green (GRN), Blue (BLU)		

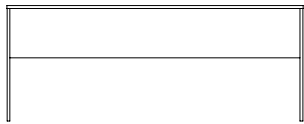
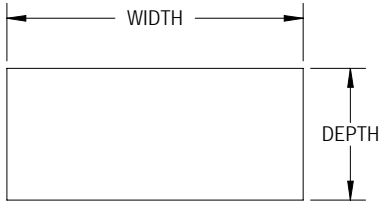
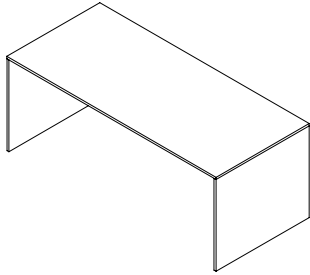

NOMINAL SIZE			LAMINATE	
WIDTH	DEPTH	HEIGHT	PRICE M1	PRICE H1
48"	36"	29"	\$937	\$1,445
60"	36"	29"	\$962	\$1,480
72"	36"	29"	\$988	\$1,561
84"	36"	29"	\$1,120	\$1,688
96"	36"	29"	\$1,152	\$1,719
48"	42"	29"	\$944	\$1,451
60"	42"	29"	\$968	\$1,483
72"	42"	29"	\$994	\$1,568
84"	42"	29"	\$1,125	\$1,697
96"	42"	29"	\$1,158	\$1,724
48"	48"	29"	\$772	\$1,189
60"	48"	29"	\$972	\$1,489
72"	48"	29"	\$998	\$1,576
84"	48"	29"	\$1,130	\$1,702
96"	48"	29"	\$1,162	\$1,732
48"	36"	36"	\$945	\$1,453
60"	36"	36"	\$971	\$1,487
72"	36"	36"	\$996	\$1,568
84"	36"	36"	\$1,128	\$1,697
96"	36"	36"	\$1,160	\$1,724
48"	42"	36"	\$952	\$1,458
60"	42"	36"	\$976	\$1,492
72"	42"	36"	\$1,002	\$1,578
84"	42"	36"	\$1,134	\$1,705
96"	42"	36"	\$1,166	\$1,733
48"	48"	36"	\$781	\$1,199
60"	48"	36"	\$981	\$1,497
72"	48"	36"	\$1,007	\$1,586
84"	48"	36"	\$1,138	\$1,712
96"	48"	36"	\$1,172	\$1,740
48"	36"	42"	\$952	\$1,458
60"	36"	42"	\$976	\$1,492
72"	36"	42"	\$1,002	\$1,573
84"	36"	42"	\$1,134	\$1,701
96"	36"	42"	\$1,166	\$1,731
48"	42"	42"	\$957	\$1,465
60"	42"	42"	\$982	\$1,499
72"	42"	42"	\$1,007	\$1,584
84"	42"	42"	\$1,140	\$1,711
96"	42"	42"	\$1,173	\$1,739
48"	48"	42"	\$790	\$1,208
60"	48"	42"	\$988	\$1,507
72"	48"	42"	\$1,016	\$1,593
84"	48"	42"	\$1,147	\$1,721
96"	48"	42"	\$1,179	\$1,749

ORDER CODE SAMPLE

LINE 1	TABLE	ITEM CODE	WIDTH	DEPTH	HEIGHT	LAMINATE
		TPRLT	W96	D48	H42	M1

Features & Specifications

No Charge Options

- Laminate codes - M1: 1" LPL, H1: 1" HPL (top only)
- All 1" LPL construction, except for modesty
- Includes single center modesty only
- Available in all standard laminates

# Integrated Parsons Table

TPRPT

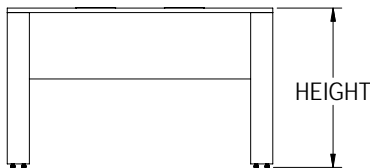
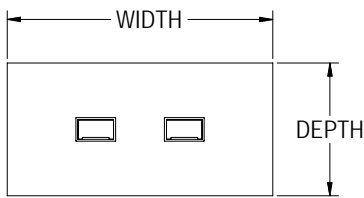
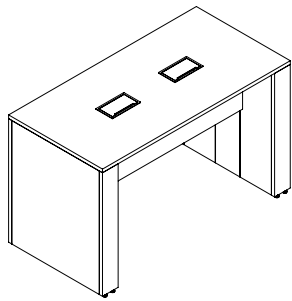

Shown with optional power & data

NOMINAL SIZE			POWER	LAMINATE	
WIDTH	DEPTH	HEIGHT	QUANTITY	PRICE M1	PRICE H1
48"	30"	29"	1 or 2	\$2,011	\$2,962
60"	30"	29"	1 or 2	\$2,057	\$3,030
72"	30"	29"	1 or 2	\$2,107	\$3,182
84"	30"	29"	1 or 2	\$2,355	\$3,417
96"	30"	29"	1 or 2	\$2,413	\$3,474
48"	36"	29"	1 or 2	\$2,093	\$3,083
60"	36"	29"	1 or 2	\$2,140	\$3,154
72"	36"	29"	1 or 2	\$2,192	\$3,312
84"	36"	29"	1 or 2	\$2,452	\$3,557
96"	36"	29"	1 or 2	\$2,512	\$3,616
48"	48"	29"	1 or 2	\$1,769	\$2,586
60"	48"	29"	1 or 2	\$2,161	\$3,167
72"	48"	29"	1 or 2	\$2,214	\$3,337
84"	48"	29"	1 or 2	\$2,469	\$3,587
96"	48"	29"	1 or 2	\$2,532	\$3,643
48"	30"	36"	1 or 2	\$2,027	\$2,979
60"	30"	36"	1 or 2	\$2,074	\$3,038
72"	30"	36"	1 or 2	\$2,123	\$3,192
84"	30"	36"	1 or 2	\$2,368	\$3,434
96"	30"	36"	1 or 2	\$2,431	\$3,486
48"	36"	36"	1 or 2	\$2,110	\$3,101
60"	36"	36"	1 or 2	\$2,159	\$3,163
72"	36"	36"	1 or 2	\$2,210	\$3,323
84"	36"	36"	1 or 2	\$2,465	\$3,575
96"	36"	36"	1 or 2	\$2,530	\$3,629
48"	48"	36"	1 or 2	\$1,789	\$2,606
60"	48"	36"	1 or 2	\$2,179	\$3,185
72"	48"	36"	1 or 2	\$2,231	\$3,358
84"	48"	36"	1 or 2	\$2,487	\$3,606
96"	48"	36"	1 or 2	\$2,551	\$3,659
48"	30"	42"	1 or 2	\$2,037	\$2,987
60"	30"	42"	1 or 2	\$2,084	\$3,052
72"	30"	42"	1 or 2	\$2,131	\$3,204
84"	30"	42"	1 or 2	\$2,380	\$3,444
96"	30"	42"	1 or 2	\$2,438	\$3,496
48"	36"	42"	1 or 2	\$2,120	\$3,109
60"	36"	42"	1 or 2	\$2,169	\$3,177
72"	36"	42"	1 or 2	\$2,218	\$3,335
84"	36"	42"	1 or 2	\$2,477	\$3,585
96"	36"	42"	1 or 2	\$2,537	\$3,639
48"	48"	42"	1 or 2	\$1,806	\$2,621
60"	48"	42"	1 or 2	\$2,192	\$3,204
72"	48"	42"	1 or 2	\$2,247	\$3,374
84"	48"	42"	1 or 2	\$2,504	\$3,624
96"	48"	42"	1 or 2	\$2,565	\$3,676

**ORDER CODE SAMPLE**

LINE 1	TABLE	ITEM CODE	WIDTH	DEPTH	HEIGHT	LAMINATE
		TPRPT	W96	D48	H42	M1
LINE 1.1	POWER & DATA	POWER OPTION	FINISH / TRIM FINISH / COVER CODE	BODY FINISH / OPTION	POWER QTY	
		AF2RE	SLV	B	1	

**Features & Specifications**

**No Charge Options**

- Laminate codes - M1: 1" LPL, H1: 1" HPL (top only)
- All 1" LPL construction, except for modesties
- Includes twin modesties & removable panel gables for wire management
- Gables are 5" thick
- Available in all standard laminates

**POWER & DATA** For detailed specification, cover code finishes, data and telecom options, and pricing of each electrical modules please refer to page "Power & Data Options".

	<p><b>AF2RE</b></p> <p><b>Finish:</b> Black (BLK), Silver (SLV), White (WHT), Anodized Aluminum (BAA), Stainless Steel (BSS)</p>
	<p><b>Option (Data &amp; Telecom):</b> A, B, C, D, E, F, G, H, J, K</p>

# Tiered Parsons Table

TPNTT

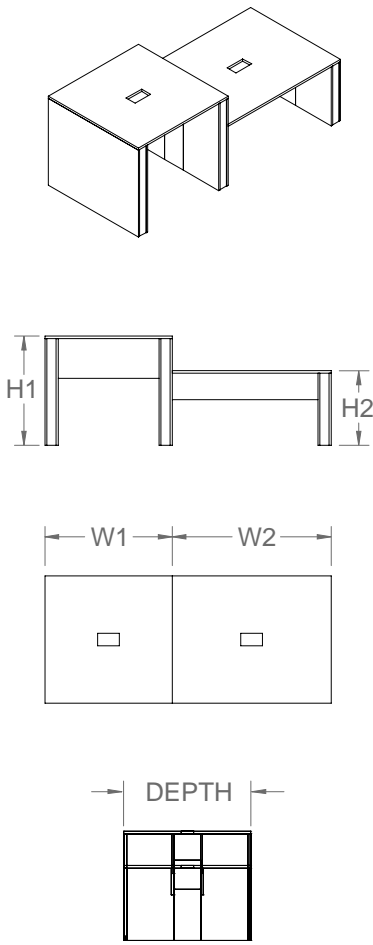

Shown with optional power & data

NOMINAL SIZE					POWER	LAMINATE	
W1	W2	DEPTH	H1	H2	QUANTITY	PRICE M1	PRICE H1
36"	60"	36"	36"	29"	H1 and/or H2	\$2,617	\$3,854
48"	60"	36"	36"	29"	H1 and/or H2	\$2,740	\$4,140
54"	60"	36"	36"	29"	H1 and/or H2	\$3,065	\$4,447
36"	72"	36"	36"	29"	H1 and/or H2	\$2,748	\$4,047
48"	72"	36"	36"	29"	H1 and/or H2	\$2,877	\$4,347
54"	72"	36"	36"	29"	H1 and/or H2	\$3,219	\$4,670
36"	96"	36"	36"	29"	H1 and/or H2	\$2,886	\$4,250
48"	96"	36"	36"	29"	H1 and/or H2	\$3,021	\$4,565
54"	96"	36"	36"	29"	H1 and/or H2	\$3,380	\$4,904
66"	96"	36"	36"	29"	H1 and/or H2	\$3,549	\$5,150
36"	60"	48"	36"	29"	H1 and/or H2	\$3,272	\$4,818
48"	60"	48"	36"	29"	H1 and/or H2	\$3,425	\$5,175
54"	60"	48"	36"	29"	H1 and/or H2	\$3,832	\$5,559
36"	72"	48"	36"	29"	H1 and/or H2	\$3,435	\$5,059
48"	72"	48"	36"	29"	H1 and/or H2	\$3,597	\$5,434
54"	72"	48"	36"	29"	H1 and/or H2	\$4,024	\$5,838
36"	96"	48"	36"	29"	H1 and/or H2	\$3,608	\$5,313
48"	96"	48"	36"	29"	H1 and/or H2	\$3,777	\$5,707
54"	96"	48"	36"	29"	H1 and/or H2	\$4,225	\$6,130
66"	96"	48"	36"	29"	H1 and/or H2	\$4,437	\$6,438
36"	60"	36"	42"	29"	H1 and/or H2	\$3,272	\$4,818
48"	60"	36"	42"	29"	H1 and/or H2	\$3,425	\$5,175
54"	60"	36"	42"	29"	H1 and/or H2	\$3,832	\$5,559
36"	72"	36"	42"	29"	H1 and/or H2	\$3,435	\$5,059
48"	72"	36"	42"	29"	H1 and/or H2	\$3,597	\$5,434
54"	72"	36"	42"	29"	H1 and/or H2	\$4,024	\$5,838
36"	96"	36"	42"	29"	H1 and/or H2	\$3,608	\$5,313
48"	96"	36"	42"	29"	H1 and/or H2	\$3,777	\$5,707
54"	96"	36"	42"	29"	H1 and/or H2	\$4,225	\$6,130
66"	96"	36"	42"	29"	H1 and/or H2	\$4,437	\$6,438
36"	60"	48"	42"	29"	H1 and/or H2	\$4,090	\$6,023
48"	60"	48"	42"	29"	H1 and/or H2	\$4,282	\$6,469
54"	60"	48"	42"	29"	H1 and/or H2	\$4,790	\$6,949
36"	72"	48"	42"	29"	H1 and/or H2	\$4,294	\$6,324
48"	72"	48"	42"	29"	H1 and/or H2	\$4,497	\$6,793
54"	72"	48"	42"	29"	H1 and/or H2	\$5,030	\$7,298
36"	96"	48"	42"	29"	H1 and/or H2	\$4,510	\$6,642
48"	96"	48"	42"	29"	H1 and/or H2	\$4,722	\$7,134
54"	96"	48"	42"	29"	H1 and/or H2	\$5,282	\$7,663
66"	96"	48"	42"	29"	H1 and/or H2	\$5,547	\$8,048

**ORDER CODE SAMPLE**

LINE 1	TABLE	ITEM CODE	W1	W2	DEPTH	H1	H2	LAMINATE
		TPNTT	W1-48	W2-72	D36	H1-42	H2-29	M1
LINE 1.1	POWER & DATA	POWER OPTION	FINISH	OPTION	POWER QTY			
		AF2RE	SLV	B	H1 H2			

**Features & Specifications**

**No Charge Options**

- Laminate codes - M1: 1" LPL, H1: 1" HPL (top only)
- All 1" LPL construction, except for modesties
- Includes twin modesties & removable panel gables for wire management
- Gables are 5" thick
- Available in all standard laminates

<b>POWER &amp; DATA</b>	For detailed specification, cover code finishes, data and telecom options, and pricing of each electrical modules please refer to page "Power & Data Options".
<b>AF2RE</b>	<b>Finish:</b> Black (BLK), Silver (SLV), White (WHT), Anodized Aluminum (BAA), Stainless Steel (BSS)
	<b>Option (Data &amp; Telecom):</b> A, B, C, D, E, F, G, H, J, K

# Console Table

TCONT

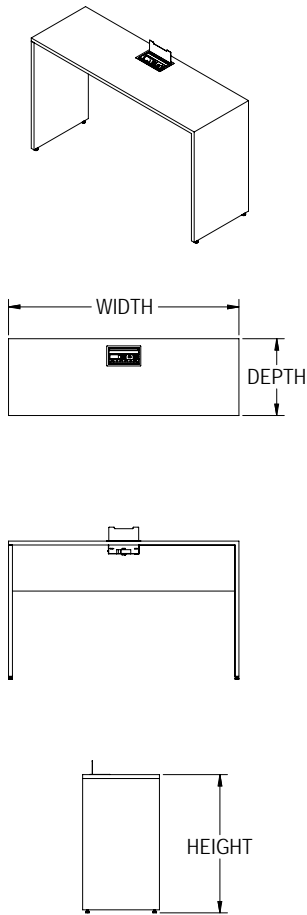

Shown with optional power & data

NOMINAL SIZE			LAMINATE	
WIDTH	DEPTH	HEIGHT	PRICE M1	PRICE H1
48"	12"	29"	\$844	\$1,301
54"	12"	29"	\$844	\$1,301
60"	12"	29"	\$861	\$1,328
66"	12"	29"	\$861	\$1,328
72"	12"	29"	\$879	\$1,355
48"	20"	29"	\$887	\$1,367
54"	20"	29"	\$887	\$1,367
60"	20"	29"	\$905	\$1,395
66"	20"	29"	\$905	\$1,395
72"	20"	29"	\$923	\$1,423
48"	12"	36"	\$887	\$1,367
54"	12"	36"	\$887	\$1,367
60"	12"	36"	\$905	\$1,395
66"	12"	36"	\$905	\$1,395
72"	12"	36"	\$923	\$1,423
48"	20"	36"	\$932	\$1,436
54"	20"	36"	\$932	\$1,436
60"	20"	36"	\$951	\$1,465
66"	20"	36"	\$951	\$1,465
72"	20"	36"	\$970	\$1,495
48"	12"	42"	\$932	\$1,436
54"	12"	42"	\$932	\$1,436
60"	12"	42"	\$951	\$1,465
66"	12"	42"	\$951	\$1,465
72"	12"	42"	\$970	\$1,495
48"	20"	42"	\$979	\$1,508
54"	20"	42"	\$979	\$1,508
60"	20"	42"	\$999	\$1,539
66"	20"	42"	\$999	\$1,539
72"	20"	42"	\$1,019	\$1,570

**ORDER CODE SAMPLE**

LINE 1	TABLE	ITEM CODE	WIDTH	DEPTH	HEIGHT	LAMINATE
		TCONT	W96	D48	H42	M1
LINE 1.1	POWER & DATA	POWER OPTION	FINISH / TRIM FINISH / COVER CODE	BODY FINISH / OPTION		
		AF2RE	SLV	E		

**Features & Specifications**

**No Charge Options**

- Laminate codes - M1: 1" LPL, H1: 1" HPL (top only)
- All 1" LPL construction, except for modesties
- Includes one power module when optioned
- Available in all standard laminates

**POWER & DATA**

For detailed specification, cover code finishes, data and telecom options, and pricing of each electrical modules please refer to page "Power & Data Options".

**AF2RE**



**Finish:** Black (BLK), Silver (SLV), White (WHT), Anodized Aluminum (BAA), Stainless Steel (BSS)

**Option (Data & Telecom):** A, B, C, D, E, F, G, H, J, K

# Meeting and Casual Tables



Designed for a wide range of use, BRC's Casual Meeting Tables offer a vast array of top and base options to suit any environment. From small meeting rooms to temporary single workstations to lunchroom tables, we've got it covered.

# Power Options: Meeting and Casual Tables

**AF2AE: Duo Flush Mount**

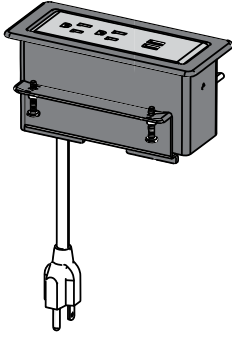

AF2AE	
FEATURES & SPECIFICATIONS	PRICE
<ul style="list-style-type: none"> <li>• Double outlet</li> <li>• Two USB ports</li> <li>• 72" Corded plug</li> <li>• Finish options: Trim: black, silver or white Body: white, grey, black, orange, red, green, blue</li> </ul>	583

**AT1FE: Top Mount Tilting**

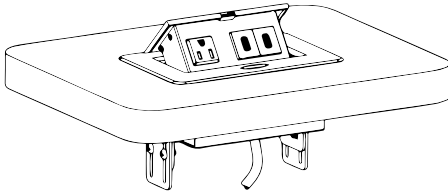

AT1FE	
FEATURES & SPECIFICATIONS	PRICE
<ul style="list-style-type: none"> <li>• Single outlet</li> <li>• 2 USB charging ports with separate power adapter</li> <li>• Push button tilting mechanism</li> <li>• 96" black power cable</li> <li>• Finish options: silver only</li> </ul>	520

**ORDER CODE SAMPLE**







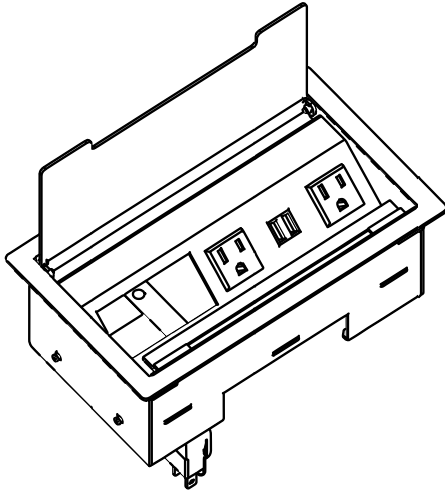



LINE 1	TABLE	ITEM CODE	WIDTH	DEPTH	LAMINATE	OPTION
		TMTLT	W60	D24	M1	CC CSC
LINE 1.1	POWER & DATA	POWER OPTION	FINISH / TRIM FINISH / COVER CODE	BODY FINISH / OPTION	POWER QTY	
		AF2AE	BLK	WHT	1	

# Power & Data Options: Meeting and Casual Tables

## AF2RE: Interact G2 Power Module



AF2RE	FINISH	
	PRICE (BLACK, SILVER, WHITE)	PRICE (ANODIZED ALUMINUM, STAINLESS STEEL)
FEATURES & SPECIFICATIONS		
<ul style="list-style-type: none"> <li>• Two power outlets on top</li> <li>• Additional power outlet on bottom for daisy chaining</li> <li>• Two USB ports</li> <li>• Hinged lid with brush gasket</li> <li>• 144" Black corded plug</li> <li>• Finish options: black, silver or white, Brushed anodized aluminum, brushed stainless steel</li> <li>• Product ships with blank plate unless additional options below are selected when ordering</li> </ul>	1,221	1,921

OPTION	FEATURE(S)	PRICE
A	 HDMI	ADD 345
B	 RJ45 CAT6	ADD 214
C	 (2) RJ45 CAT6	ADD 426
D	 (3) RJ45 CAT6	ADD 637
E	 RJ11 CAT3, RJ45 CAT6, USB	ADD 715
F	 RJ11 CAT3, RJ45 CAT6	ADD 319
G	 RJ11 CAT3, (2) RJ45 CAT6	ADD 531
H	 (3) RJ45 CAT5E	ADD 637
J	 VGA, (2) RJ45 CAT6	ADD 680
K	 VGA, RJ45 CAT6, STEREO 3.5	ADD 573

### ORDER CODE SAMPLE

LINE 1	TABLE	ITEM CODE	WIDTH	DEPTH	LAMINATE	OPTION
		TFRTT	W276	D48	M1	CC
LINE 1.1	POWER & DATA	POWER OPTION	FINISH / TRIM FINISH / COVER CODE	BODY FINISH / OPTION	POWER QTY	
		AF2RE	SILVER	D	1	

# Wire Management & Power & Data Location: Casual Tables

## Wire Management

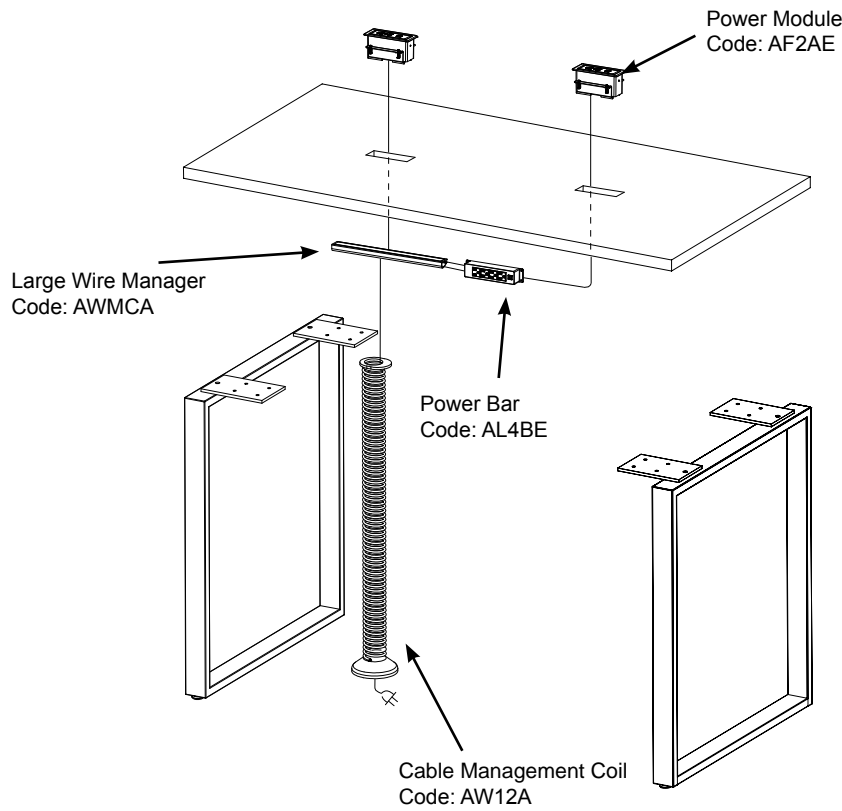

Wire managers will be included with any purchase of power modules. Cable management coils & power bars can be ordered separately from Accessories Price Guide.

## Power Locations

By default, electrical modules, when specified from this price guide, are located as per below. If one electrical module is specified it will be located on the center. If there are two specified, they will be distanced equally in the center.

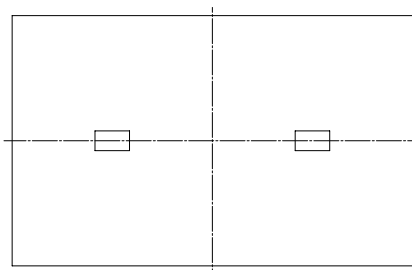
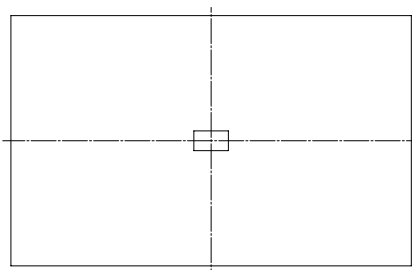

# Square & Rectangular Occasional Table

TCOFT

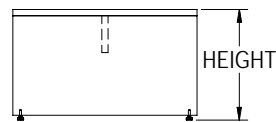
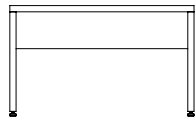
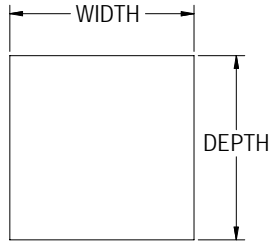
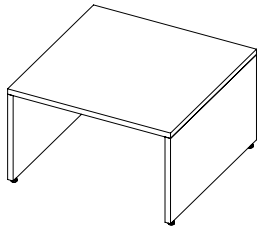

NOMINAL SIZE			LAMINATE	
WIDTH	DEPTH	HEIGHT	PRICE M1	PRICE H1
18"	18"	18"	427	564
24"	18"	18"	438	578
30"	18"	18"	449	593
36"	18"	18"	460	607
42"	18"	18"	471	621
48"	18"	18"	481	635
24"	24"	18"	453	597
30"	24"	18"	467	616
36"	24"	18"	481	635
42"	24"	18"	496	654
48"	24"	18"	510	673
30"	30"	18"	485	640
36"	30"	18"	503	664
42"	30"	18"	521	688
48"	30"	18"	539	711
36"	36"	18"	525	692
42"	36"	18"	546	721
48"	36"	18"	568	749
36"	42"	18"	546	721
42"	42"	18"	571	754
48"	42"	18"	597	788
48"	48"	18"	625	826

**ORDER CODE SAMPLE**

LINE 1	TABLE	ITEM CODE	WIDTH	DEPTH	HEIGHT	LAMINATE
		TCOFT	W24	D24	18"	M1

**Features & Specifications**

- 3/4" LPL Construction
- Laminate codes - M1: 1" LPL, H1: 1" HPL (top only)

**No Charge Options**

- Available in all standard laminates and metal finishes

PRODUCT MAP  
CONFERENCE TABLES  
MEDIA TABLES  
PARSONS TABLES  
MEETING & CASUAL TABLES  
NEST TRAINING TABLES  
www.brc.group

# Round Occasional Table

TCFRT

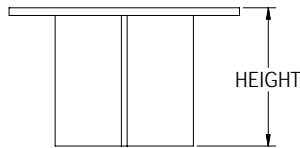
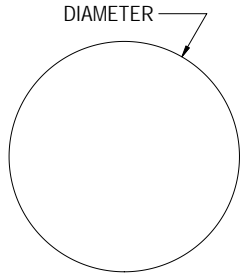
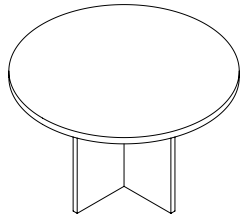

NOMINAL SIZE		LAMINATE	
WIDTH	HEIGHT	PRICE <i>M1</i>	PRICE <i>H1</i>
18"	18"	572	709
24"	18"	598	742
30"	18"	630	785
36"	18"	670	837
42"	18"	716	899
48"	18"	770	971

**ORDER CODE SAMPLE**

LINE 1	TABLE	ITEM CODE	DIAMETER	HEIGHT	LAMINATE
		TCFRT	D24	H18	<i>M1</i>

**Features & Specifications**

- 3/4" LPL Construction
- Laminate codes - M1: 1" LPL, H1: 1" HPL (top only)

**No Charge Options**

- Available in all standard laminates and metal finishes

PRODUCT MAP

CONFERENCE TABLES

MEDIA TABLES

PARSONS TABLES

MEETING & CASUAL TABLES

NEST TRAINING TABLES

www.bic.group

# Star Base, Round Top Meeting & Casual Table

TMDCT

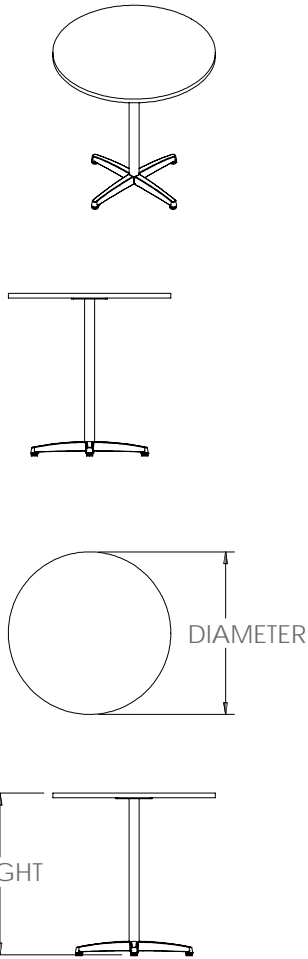

NOMINAL SIZE		LAMINATE		
DIAMETER	HEIGHT	PRICE M1	PRICE H1	PRICE K1
24"	18"	\$1,600	\$1,719	\$1,926
30"	18"	\$1,830	\$2,036	\$2,405
36"	18"	\$1,897	\$2,154	\$2,611
42"	18"	\$2,101	\$2,358	\$2,823
48"	18"	\$2,134	\$2,410	\$2,895
24"	29"	\$1,684	\$1,809	\$2,027
30"	29"	\$1,926	\$2,143	\$2,531
36"	29"	\$1,996	\$2,267	\$2,748
42"	29"	\$2,211	\$2,482	\$2,971
48"	29"	\$2,246	\$2,536	\$3,047
24"	36"	\$1,684	\$1,990	\$2,230
30"	36"	\$1,926	\$2,358	\$2,785
36"	36"	\$1,996	\$2,494	\$3,023
42"	36"	\$2,211	\$2,731	\$3,269
48"	36"	\$2,246	\$2,790	\$3,352
24"	42"	\$2,092	\$2,216	\$2,435
30"	42"	\$2,334	\$2,551	\$2,936
36"	42"	\$2,404	\$2,673	\$3,155
42"	42"	\$2,617	\$2,890	\$3,376
48"	42"	\$2,653	\$2,941	\$3,454

**ORDER CODE SAMPLE**

LINE 1	TABLE	ITEM CODE	DIAMETER	HEIGHT	LAMINATE
		TMDCT	D24	H29	M1

**Features & Specifications**

- Laminate codes - M1: 1" LPL, H1: 1" HPL, K1: 1.25" knife edge (top only)
- Includes levellers
- Metal base construction

**No Charge Options**

- Available in all standard laminates and metal finishes

# Star Base, Square Top Meeting & Casual Table

TMSDT

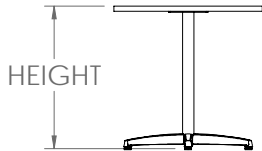
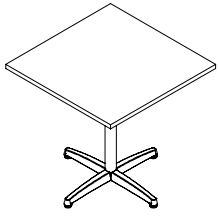

NOMINAL SIZE		LAMINATE		
WIDTH	HEIGHT	PRICE M1	PRICE H1	PRICE K1
24"	18"	\$1,437	\$1,553	\$1,763
30"	18"	\$1,687	\$1,892	\$2,261
36"	18"	\$1,775	\$1,984	\$2,354
42"	18"	\$1,782	\$1,992	\$2,370
24"	29"	\$1,494	\$1,616	\$1,837
30"	29"	\$1,757	\$1,973	\$2,361
36"	29"	\$1,850	\$2,070	\$2,459
42"	29"	\$1,857	\$2,078	\$2,476
24"	42"	\$1,900	\$2,023	\$2,242
30"	42"	\$2,163	\$2,381	\$2,767
36"	42"	\$2,256	\$2,477	\$2,867
42"	42"	\$2,263	\$2,485	\$2,881

**ORDER CODE SAMPLE**

LINE 1	TABLE	ITEM CODE	WIDTH	HEIGHT	LAMINATE	OPTION
		TMXST	W24	H29	M1	CC CSR

**Features & Specifications**

- Laminate codes - M1: 1" LPL, H1: 1" HPL, K1: 1.25" knife edge (top only)
- Metal base construction

**No Charge Options**

- Available in all standard laminates and metal finishes

**Optional Extra**

- For 3" curved corners add option code "CC" and \$349

PRODUCT MAP  
CONFERENCE TABLES  
MEDIA TABLES  
PARSONS TABLES  
MEETING & CASUAL TABLES  
NEST TRAINING TABLES  
www.brc.group

# Flat Base Large Meeting & Casual Table

TMSBT

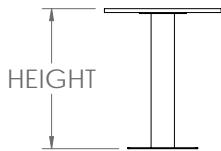
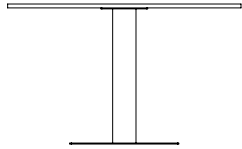
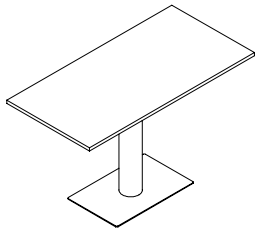

NOMINAL SIZE			LAMINATE		
WIDTH	DEPTH	HEIGHT	PRICE M1	PRICE H1	PRICE K1
48"	30"	29"	\$1,977	\$2,176	\$2,442
60"	30"	29"	\$2,331	\$2,611	\$3,234
66"	30"	29"	\$2,338	\$2,620	\$3,234
72"	30"	29"	\$2,347	\$2,632	\$3,238
48"	36"	29"	\$2,428	\$2,713	\$3,220
60"	36"	29"	\$2,589	\$2,879	\$3,394
66"	36"	29"	\$2,594	\$2,887	\$3,409
72"	36"	29"	\$2,604	\$2,899	\$3,472
60"	42"	29"	\$2,202	\$2,602	\$2,902
66"	42"	29"	\$2,207	\$2,607	\$2,907
72"	42"	29"	\$2,213	\$2,613	\$2,913
48"	30"	36"	\$2,175	\$2,394	\$2,687
60"	30"	36"	\$2,565	\$2,873	\$3,558
66"	30"	36"	\$2,572	\$2,883	\$3,558
72"	30"	36"	\$2,582	\$2,896	\$3,562
48"	36"	36"	\$2,671	\$2,985	\$3,543
60"	36"	36"	\$2,848	\$3,167	\$3,734
66"	36"	36"	\$2,854	\$3,176	\$3,750
72"	36"	36"	\$2,865	\$3,189	\$3,820
60"	42"	36"	\$2,423	\$2,863	\$3,193
66"	42"	36"	\$2,428	\$2,868	\$3,198
72"	42"	36"	\$2,435	\$2,875	\$3,205
48"	30"	42"	\$2,373	\$2,612	\$2,931
60"	30"	42"	\$2,798	\$3,134	\$3,881
66"	30"	42"	\$2,806	\$3,144	\$3,881
72"	30"	42"	\$2,817	\$3,159	\$3,886
48"	36"	42"	\$2,914	\$3,256	\$3,864
60"	36"	42"	\$3,107	\$3,455	\$4,073
66"	36"	42"	\$3,113	\$3,465	\$4,091
72"	36"	42"	\$3,125	\$3,479	\$4,167
60"	42"	42"	\$2,643	\$3,123	\$3,483
66"	42"	42"	\$2,649	\$3,129	\$3,489
72"	42"	42"	\$2,656	\$3,136	\$3,496

**ORDER CODE SAMPLE**

LINE 1	TABLE	ITEM CODE	WIDTH	DEPTH	HEIGHT	LAMINATE	OPTION
		TMTLT	W60	D24	H42	M1	CC
LINE 1.1	POWER & DATA	POWER OPTION	FINISH / TRIM FINISH / COVER CODE	OPTION			
		AF2RE	BLK	B			

**Features & Specifications**

No Charge Options  
Optional Extra

- Laminate codes - M1: 1" LPL, H1: 1" HPL, K1: 1.25" knife edge (top only)
- Metal base construction
- Includes levellers
- Optional power is located offset from the center of table
- Available in all standard laminates and metal finishes
- For 3" curved corners add option code "CC" and \$349

**POWER & DATA** For detailed specification, cover code finishes, data and telecom options, and pricing of each electrical modules please refer to page "Power & Data Options".

	<p><b>AF2RE</b></p> <p><b>Finish:</b> Black (BLK), Silver (SLV), White (WHT), Anodized Aluminum (BAA), Stainless Steel (BSS)</p>
	<p><b>Option (Data &amp; Telecom):</b> A, B, C, D, E, F, G, H, J, K</p>

# Flat Base Small Meeting & Casual Table

TMFST

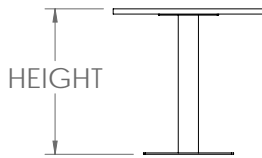
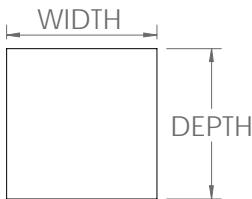
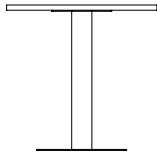
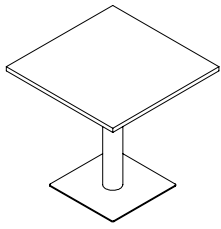

NOMINAL SIZE			LAMINATE		
WIDTH	DEPTH	HEIGHT	PRICE M1	PRICE H1	PRICE K1
18"	18"	18"	\$1,582	\$1,741	\$1,954
24"	24"	18"	\$1,865	\$2,089	\$2,588
30"	30"	18"	\$1,871	\$2,096	\$2,588
36"	36"	18"	\$1,878	\$2,106	\$2,591
18"	18"	29"	\$1,662	\$1,829	\$2,052
24"	24"	29"	\$1,959	\$2,194	\$2,718
30"	30"	29"	\$1,965	\$2,201	\$2,718
36"	36"	29"	\$1,972	\$2,212	\$2,721
18"	18"	36"	\$1,746	\$1,921	\$2,155
24"	24"	36"	\$2,057	\$2,304	\$2,854
30"	30"	36"	\$2,064	\$2,312	\$2,854
36"	36"	36"	\$2,071	\$2,323	\$2,858
18"	30"	42"	\$1,834	\$2,018	\$2,263
24"	30"	42"	\$2,160	\$2,420	\$2,997
30"	30"	42"	\$2,168	\$2,428	\$2,997
36"	36"	42"	\$2,175	\$2,440	\$3,001

**ORDER CODE SAMPLE**

LINE 1	TABLE	ITEM CODE	WIDTH	DEPTH	HEIGHT	LAMINATE	OPTION
		TMFST	W24	D24	H42	M1	CC
LINE 1.1	POWER & DATA	POWER OPTION	FINISH / TRIM FINISH / COVER CODE	OPTION			
		AF2RE	BLK	B			

**Features & Specifications**

No Charge Options  
Optional Extra

- Laminate codes - M1: 1" LPL, H1: 1" HPL, K1: 1.25" knife edge (top only)
- Metal base construction
- Includes levellers
- Optional power is located offset from the center of table
- Available in all standard laminates and metal finishes
- For 3" curved corners add option code "CC" and \$349

**POWER & DATA** For detailed specification, cover code finishes, data and telecom options, and pricing of each electrical modules please refer to page "Power & Data Options".

 <p><b>AF2RE</b></p>	<p><b>Finish:</b> Black (BLK), Silver (SLV), White (WHT), Anodized Aluminum (BAA), Stainless Steel (BSS)</p>
	<p><b>Option (Data &amp; Telecom):</b> A, B, C, D, E, F, G, H, J, K</p>

PRODUCT MAP  
CONFERENCE TABLES  
MEDIA TABLES  
PARSONS TABLES  
MEETING & CASUAL TABLES  
NEST TRAINING TABLES  
www.brc.group

# Disc Base, Round Top Meeting & Casual Table

TMDRT

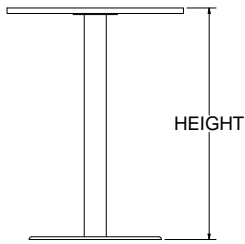
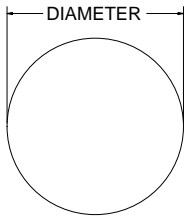
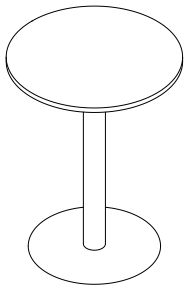

NOMINAL SIZE		LAMINATE		
DIAMETER	HEIGHT	PRICE M1	PRICE H1	PRICE K1
24"	18"	\$1,600	\$1,719	\$1,926
30"	18"	\$1,830	\$2,036	\$2,405
36"	18"	\$1,897	\$2,154	\$2,611
42"	18"	\$2,101	\$2,358	\$2,823
48"	18"	\$2,134	\$2,410	\$2,895
24"	29"	\$1,684	\$1,809	\$2,027
30"	29"	\$1,926	\$2,143	\$2,531
36"	29"	\$1,996	\$2,267	\$2,748
42"	29"	\$2,211	\$2,482	\$2,971
48"	29"	\$2,246	\$2,536	\$3,047
24"	42"	\$2,092	\$2,216	\$2,435
30"	42"	\$2,334	\$2,551	\$2,936
36"	42"	\$2,404	\$2,673	\$3,155
42"	42"	\$2,617	\$2,890	\$3,376
48"	42"	\$2,653	\$2,941	\$3,454

**ORDER CODE SAMPLE**

LINE 1	TABLE	ITEM CODE	DIAMETER	HEIGHT	LAMINATE	OPTION
		TMDRT	D24	H29	M1	LV

**Features & Specifications**

- Laminate codes - M1: 1" LPL, H1: 1" HPL, K1: 1.25" knife edge (top only)
- Metal base construction

**No Charge Options**

- Available in all standard laminates and metal finishes

**Optional Extra**

- For levelling option add option code "LV" and \$158

PRODUCT MAP  
CONFERENCE TABLES  
MEDIA TABLES  
PARSONS TABLES  
MEETING & CASUAL TABLES  
NEST TRAINING TABLES  
www.brc.group

# Disc Base, Square Top Meeting & Casual Table

TMDST

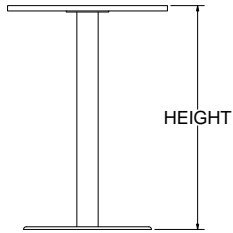
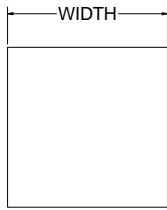
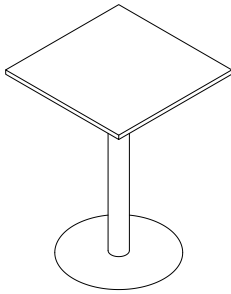

NOMINAL SIZE		LAMINATE		
WIDTH	HEIGHT	PRICE M1	PRICE H1	PRICE K1
24"	18"	\$1,539	\$1,655	\$1,863
30"	18"	\$1,767	\$1,974	\$2,341
36"	18"	\$1,773	\$1,981	\$2,354
42"	18"	\$1,976	\$2,187	\$2,563
48"	18"	\$2,008	\$2,231	\$2,630
24"	29"	\$1,619	\$1,742	\$1,961
30"	29"	\$1,860	\$2,077	\$2,464
36"	29"	\$1,866	\$2,085	\$2,477
42"	29"	\$2,080	\$2,302	\$2,697
48"	29"	\$2,113	\$2,348	\$2,768
24"	42"	\$2,026	\$2,149	\$2,367
30"	42"	\$2,267	\$2,485	\$2,870
36"	42"	\$2,273	\$2,492	\$2,884
42"	42"	\$2,487	\$2,709	\$3,104
48"	42"	\$2,519	\$2,754	\$3,175

**ORDER CODE SAMPLE**

LINE 1	TABLE	ITEM CODE	WIDTH	HEIGHT	LAMINATE	OPTION
		TMDST	W24	H29	M1	CC LV

**Features & Specifications**

- Laminate codes - M1: 1" LPL, H1: 1" HPL, K1: 1.25" knife edge (top only)
- Metal base construction

**No Charge Options**

- Available in all standard laminates and metal finishes

**Optional Extra**

- For 3" curved corners add option code "CC" and \$349
- For levelling option add option code "LV" and \$158

PRODUCT MAP  
CONFERENCE TABLES  
MEDIA TABLES  
PARSONS TABLES  
MEETING & CASUAL TABLES  
NEST TRAINING TABLES  
www.brc.group

# Tubular X Base, Round Top Meeting & Casual Table TMXRT

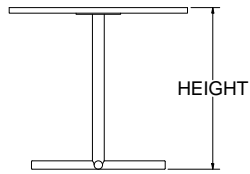
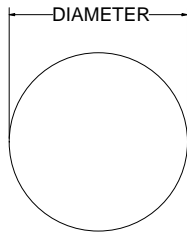

NOMINAL SIZE		LAMINATE		
DIAMETER	HEIGHT	PRICE M1	PRICE H1	PRICE K1
24"	18"	\$1,152	\$1,268	\$1,475
30"	18"	\$1,400	\$1,607	\$1,975
36"	18"	\$1,466	\$1,723	\$2,181
42"	18"	\$1,556	\$1,816	\$2,278
24"	29"	\$1,212	\$1,334	\$1,552
30"	29"	\$1,473	\$1,691	\$2,078
36"	29"	\$1,543	\$1,813	\$2,295
42"	29"	\$1,637	\$1,911	\$2,397
24"	42"	\$1,618	\$1,740	\$1,957
30"	42"	\$1,881	\$2,098	\$2,485
36"	42"	\$1,951	\$2,220	\$2,702
42"	42"	\$2,045	\$2,318	\$2,804

## ORDER CODE SAMPLE

LINE 1	TABLE	ITEM CODE	DIAMETER	HEIGHT	LAMINATE	OPTION
		TMXRT	D24	H29	M1	CSR

### Features & Specifications

- Laminate codes - M1: 1" LPL, H1: 1" HPL, K1: 1.25" knife edge (top only)
- Metal base construction

### No Charge Options

- Available in all standard laminates and metal finishes

### Optional Extra

- For hard wheel casters add option code "CSC" and \$110
- For soft wheel casters add option code "CSR" and \$166

# Tubular X Base, Square Top Meeting & Casual Table TMXST

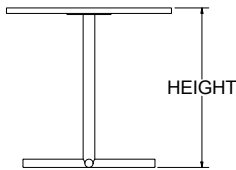
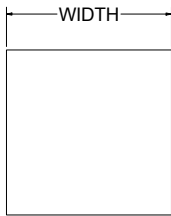
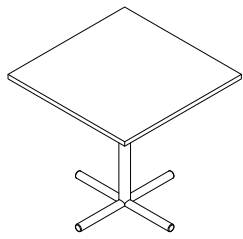

NOMINAL SIZE		LAMINATE		
WIDTH	HEIGHT	PRICE M1	PRICE H1	PRICE K1
24"	18"	\$1,087	\$1,203	\$1,413
30"	18"	\$1,337	\$1,542	\$1,911
36"	18"	\$1,425	\$1,634	\$2,004
42"	18"	\$1,432	\$1,642	\$2,020
24"	29"	\$1,144	\$1,266	\$1,487
30"	29"	\$1,407	\$1,623	\$2,011
36"	29"	\$1,500	\$1,720	\$2,109
42"	29"	\$1,507	\$1,728	\$2,126
24"	42"	\$1,550	\$1,673	\$1,892
30"	42"	\$1,813	\$2,031	\$2,417
36"	42"	\$1,906	\$2,127	\$2,517
42"	42"	\$1,913	\$2,135	\$2,531

## ORDER CODE SAMPLE

LINE 1	TABLE	ITEM CODE	WIDTH	HEIGHT	LAMINATE	OPTION
		TMXST	W24	H29	M1	CC CSR

### Features & Specifications

- Laminate codes - M1: 1" LPL, H1: 1" HPL, K1: 1.25" knife edge (top only)
- Metal base construction

### No Charge Options

- Available in all standard laminates and metal finishes

### Optional Extra

- For 3" curved corners add option code "CC" and \$349
- For hard wheel casters add option code "CSC" and \$110
- For soft wheel casters add option code "CSR" and \$166

# Tubular T Base Meeting & Casual Table

TMTLT

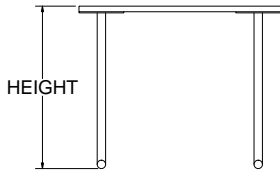
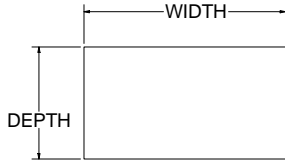
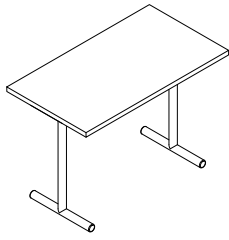

NOMINAL SIZE		POWER	LAMINATE		
WIDTH	DEPTH	QUANTITY	PRICE M1	PRICE H1	PRICE K1
36"	20"	1, 2	\$1,391	\$1,545	\$1,813
48"	20"	1, 2	\$1,405	\$1,563	\$1,842
60"	20"	1, 2	\$1,684	\$1,895	\$2,267
66"	20"	1, 2	\$1,693	\$1,903	\$2,280
72"	20"	1, 2	\$1,699	\$1,913	\$2,294
36"	24"	1, 2	\$1,415	\$1,569	\$1,844
42"	24"	1, 2	\$1,420	\$1,578	\$1,858
48"	24"	1, 2	\$1,428	\$1,589	\$1,872
60"	24"	1, 2	\$1,707	\$1,919	\$2,295
66"	24"	1, 2	\$1,713	\$1,927	\$2,310
72"	24"	1, 2	\$1,721	\$1,937	\$2,323
36"	30"	1, 2	\$1,538	\$1,730	\$2,008
42"	30"	1, 2	\$1,545	\$1,740	\$2,014
48"	30"	1, 2	\$1,552	\$1,751	\$2,017
60"	30"	1, 2	\$1,906	\$2,186	\$2,809
66"	30"	1, 2	\$1,913	\$2,195	\$2,809
72"	30"	1, 2	\$1,922	\$2,207	\$2,813
36"	36"	1, 2	\$1,834	\$2,054	\$2,446
42"	36"	1, 2	\$1,996	\$2,270	\$2,770
48"	36"	1, 2	\$2,003	\$2,288	\$2,795
60"	36"	1, 2	\$2,164	\$2,454	\$2,969
66"	36"	1, 2	\$2,169	\$2,462	\$2,984
72"	36"	1, 2	\$2,179	\$2,474	\$3,047
84"	36"	1, 2	\$2,185	\$2,482	\$3,052
96"	36"	1, 2	\$2,192	\$2,491	\$3,056
60"	42"	1, 2	\$1,777	\$2,177	\$2,477
66"	42"	1, 2	\$1,782	\$2,182	\$2,482
72"	42"	1, 2	\$1,788	\$2,188	\$2,488
84"	42"	1, 2	\$1,798	\$2,198	\$2,498
96"	42"	1, 2	\$1,883	\$2,283	\$2,583

**ORDER CODE SAMPLE**

LINE 1	TABLE	ITEM CODE	WIDTH	DEPTH	LAMINATE	OPTION
		TMTLT	W60	D24	M1	CC CSC
LINE 1.1	POWER & DATA	POWER OPTION	FINISH / TRIM FINISH / COVER CODE	BODY FINISH / OPTION	POWER QTY	
		AF2AE	BLK	WHT	1	

**Features & Specifications**

- Laminate codes - M1: 1" LPL, H1: 1" HPL, K1: 1.25" knife edge (top only)
- Metal base construction
- Height is 29" nominal, including levellers
- Tables with 60" width and above have anti deflection bar
- Available in all standard laminates and metal finishes
- For 3" curved corners add option code "CC" and \$349
- For hard wheel casters add option code "CSC" and \$110
- For soft wheel casters add option code "CSR" and \$166

No Charge Options  
Optional Extra

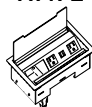
<b>POWER</b>	For detailed specification, cover code finishes, data and telecom options, and pricing of each electrical modules please refer to page "Power & Data Options".		
<b>AF2AE</b> 	<b>Trim Finish:</b> Black (BLK), Silver (SLV), White (WHT)		<b>AT1FE</b> 
	<b>Body Finish:</b> White (WHT), Gray (GRY), Black (BLK), Orange (ORN), Red (RED), Green (GRN), Blue (BLU)		

PRODUCT MAP  
CONFERENCE TABLES  
MEDIA TABLES  
PARSONS TABLES  
MEETING & CASUAL TABLES  
NEST TRAINING TABLES  
www.brc.group

# Tapered Post Leg Meeting & Casual Table

TMTPT

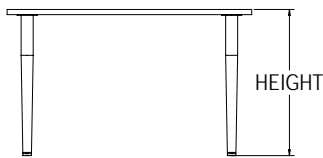
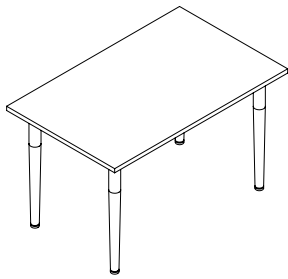

NOMINAL SIZE		LAMINATE	
WIDTH	DEPTH	PRICE M1	PRICE H1
36"	24"	\$1,098	\$1,254
42"	24"	\$1,107	\$1,264
48"	24"	\$1,113	\$1,273
60"	24"	\$1,247	\$1,459
66"	24"	\$1,254	\$1,468
72"	24"	\$1,260	\$1,478
36"	30"	\$1,199	\$1,394
42"	30"	\$1,207	\$1,404
48"	30"	\$1,214	\$1,414
60"	30"	\$1,420	\$1,701
66"	30"	\$1,428	\$1,710
72"	30"	\$1,436	\$1,721
36"	36"	\$1,267	\$1,488
42"	36"	\$1,428	\$1,702
48"	36"	\$1,436	\$1,720
60"	36"	\$1,448	\$1,737
66"	36"	\$1,455	\$1,748
72"	36"	\$1,462	\$1,758
84"	36"	\$1,468	\$1,768
96"	36"	\$1,475	\$1,777
60"	42"	\$1,448	\$1,737
66"	42"	\$1,455	\$1,748
72"	42"	\$1,462	\$1,758
84"	42"	\$1,468	\$1,768
96"	42"	\$1,475	\$1,777
60"	48"	\$1,448	\$1,737
66"	48"	\$1,455	\$1,748
72"	48"	\$1,462	\$1,758
84"	48"	\$1,468	\$1,768
96"	48"	\$1,475	\$1,777

**ORDER CODE SAMPLE**

LINE 1	TABLE	ITEM CODE	WIDTH	DEPTH	LAMINATE	OPTION
		TMTPT	W60	D24	M1	CC
LINE 1.1	POWER & DATA	POWER OPTION	FINISH / TRIM FINISH / COVER CODE	BODY FINISH / OPTION	POWER QTY	
		AF2AE	BLK	WHT	1	

**Features & Specifications**

No Charge Options  
Optional Extra

- Laminate codes - M1: 1" LPL, H1: 1" HPL, K1: 1.25" knife edge (top only)
- Metal base construction
- Height is 29" nominal, including lellers
- 72" & 84" include anti deflection bar; 96" includes 6 legs
- Available in all standard laminates and metal finishes
- For 3" curved corners add option code "CC" and \$349
- Casters not available on this base

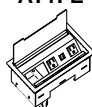
<b>POWER</b>	For detailed specification, cover code finishes, data and telecom options, and pricing of each electrical modules please refer to page "Power & Data Options".		
 <b>AF2AE</b>	Trim Finish: Black (BLK), Silver (SLV), White (WHT)		 <b>AT1FE</b> Finish: Silver (SLV) Only
	Body Finish: White (WHT), Gray (GRY), Black (BLK), Orange (ORN), Red (RED), Green (GRN), Blue (BLU)		

# Post Leg Meeting & Casual Table

TMPLT

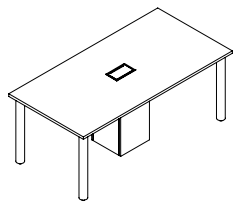
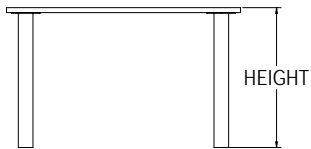
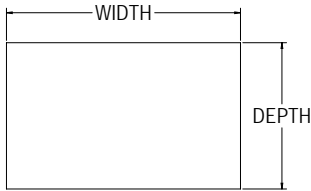
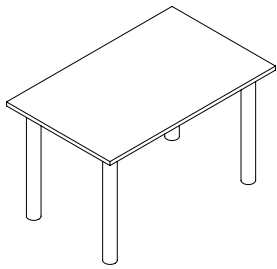

Shown with optional power & laminate pedestal wire enclosure

NOMINAL SIZE		LAMINATE	
WIDTH	DEPTH	PRICE M1	PRICE H1
36"	24"	\$765	\$920
42"	24"	\$773	\$930
48"	24"	\$779	\$938
60"	24"	\$913	\$1,124
66"	24"	\$920	\$1,135
72"	24"	\$927	\$1,143
36"	30"	\$866	\$1,059
42"	30"	\$874	\$1,068
48"	30"	\$880	\$1,079
60"	30"	\$1,087	\$1,366
66"	30"	\$1,094	\$1,376
72"	30"	\$1,101	\$1,386
36"	36"	\$933	\$1,152
42"	36"	\$1,094	\$1,368
48"	36"	\$1,098	\$1,386
60"	36"	\$1,113	\$1,402
66"	36"	\$1,119	\$1,412
72"	36"	\$1,128	\$1,422
84"	36"	\$1,135	\$1,432
96"	36"	\$1,142	\$1,441
60"	42"	\$1,113	\$1,402
66"	42"	\$1,119	\$1,412
72"	42"	\$1,128	\$1,422
84"	42"	\$1,135	\$1,432
96"	42"	\$1,142	\$1,441
60"	48"	\$1,113	\$1,402
66"	48"	\$1,119	\$1,412
72"	48"	\$1,128	\$1,422
84"	48"	\$1,135	\$1,432
96"	48"	\$1,142	\$1,441

**ORDER CODE SAMPLE**

LINE 1	TABLE	ITEM CODE	WIDTH	DEPTH	LAMINATE	OPTION
		TMPLT	W60	D24	M1	CC WC
LINE 1.1	POWER & DATA	POWER OPTION	FINISH / TRIM FINISH / COVER CODE	BODY FINISH / OPTION	POWER QTY	
		AF2AE	BLK	WHT	1	

**Features & Specifications**

No Charge Options  
Optional Extra

- Laminate codes - M1: 1" LPL, H1: 1" HPL, K1: 1.25" knife edge (top only)
- Metal base construction
- Height is 29" nominal, including lellers
- 72" & 84" include anti deflection bar; 96" includes 6 legs
- Available in all standard laminates and metal finishes
- For 3" curved corners add option code "CC" and \$349
- For 14" square laminate pedestal wire enclosure add option code 'WC' and \$625
- Casters not available on this base

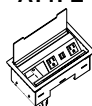
<b>POWER</b>	For detailed specification, cover code finishes, data and telecom options, and pricing of each electrical modules please refer to page "Power & Data Options".		
<b>AF2AE</b> 	<b>Trim Finish:</b> Black (BLK), Silver (SLV), White (WHT)		<b>AT1FE</b> 
	<b>Body Finish:</b> White (WHT), Gray (GRY), Black (BLK), Orange (ORN), Red (RED), Green (GRN), Blue (BLU)		

# York X Base, Round Top Meeting & Casual Table

TMPRT

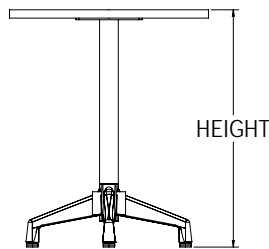
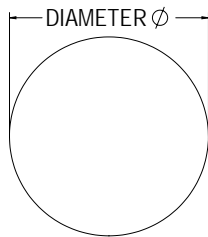
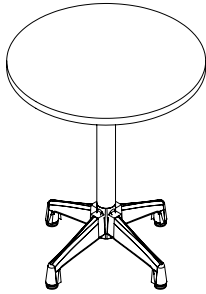

NOMINAL SIZE		LAMINATE		
DIAMETER	HEIGHT	PRICE M1	PRICE H1	PRICE K1
24"	29"	\$1,256	\$1,378	\$1,597
30"	29"	\$1,571	\$1,788	\$2,175
36"	29"	\$1,642	\$1,912	\$2,393
42"	29"	\$1,698	\$1,971	\$2,457
24"	42"	\$1,571	\$1,695	\$1,913
30"	42"	\$1,888	\$2,105	\$2,490
36"	42"	\$1,956	\$2,229	\$2,709
42"	42"	\$2,014	\$2,287	\$2,773

**ORDER CODE SAMPLE**

LINE 1	TABLE	ITEM CODE	WIDTH	HEIGHT	LAMINATE	OPTION
		TMPRT	W24	H29	M1	CSR

**Features & Specifications**

No Charge Options  
Optional Extra

- Laminate codes - M1: 1" LPL, H1: 1" HPL, K1: 1.25" knife edge (top only)
- Metal base construction
- Available in all standard laminates and metal finishes
- For hard wheel casters add option code "CSC" and \$110
- For soft wheel casters add option code "CSR" and \$166

PRODUCT MAP  
CONFERENCE TABLES  
MEDIA TABLES  
PARSONS TABLES  
MEETING & CASUAL TABLES  
NEST TRAINING TABLES  
www.brc.group

# York X Base, Square Top Meeting & Casual Table

TMPST

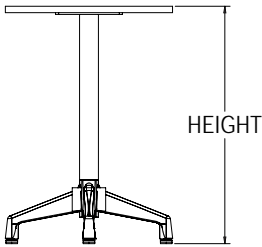
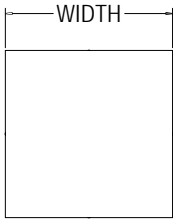
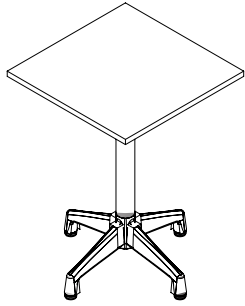

NOMINAL SIZE		LAMINATE		
WIDTH	HEIGHT	PRICE M1	PRICE H1	PRICE K1
24"	29"	\$1,188	\$1,311	\$1,529
30"	29"	\$1,505	\$1,722	\$2,107
36"	29"	\$1,512	\$1,731	\$2,123
42"	29"	\$1,567	\$1,788	\$2,184
24"	42"	\$1,505	\$1,628	\$1,846
30"	42"	\$1,821	\$2,037	\$2,424
36"	42"	\$1,828	\$2,047	\$2,438
42"	42"	\$1,884	\$2,105	\$2,501

**ORDER CODE SAMPLE**

LINE 1	TABLE	ITEM CODE	WIDTH	HEIGHT	LAMINATE	OPTION
		TMPST	W24	H29	M1	CC CSR

**Features & Specifications**

No Charge Options  
Optional Extra

- Laminate codes - M1: 1" LPL, H1: 1" HPL, K1: 1.25" knife edge (top only)
- Metal base construction
- Available in all standard laminates and metal finishes
- For 3" curved corners add option code "CC" and \$349
- For hard wheel casters add option code "CSC" and \$110
- For soft wheel casters add option code "CSR" and \$166

PRODUCT MAP  
CONFERENCE TABLES  
MEDIA TABLES  
PARSONS TABLES  
MEETING & CASUAL TABLES  
NEST TRAINING TABLES  
www.brc.group

# York T Base Meeting & Casual Table

TMPTT

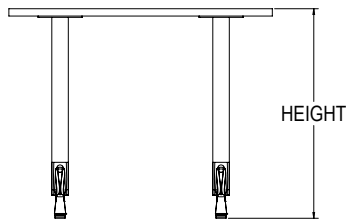
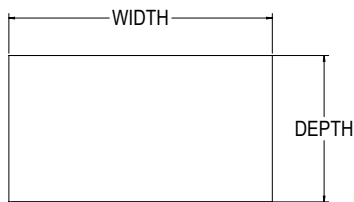
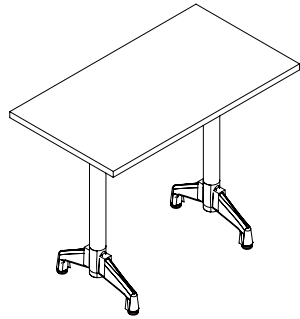

NOMINAL SIZE		POWER	LAMINATE		
WIDTH	DEPTH	QUANTITY	PRICE M1	PRICE H1	PRICE K1
36"	20"	1, 2	\$1,572	\$1,724	\$1,994
48"	20"	1, 2	\$1,587	\$1,743	\$2,022
60"	20"	1, 2	\$1,864	\$2,075	\$2,447
66"	20"	1, 2	\$1,872	\$2,083	\$2,460
72"	20"	1, 2	\$1,878	\$2,092	\$2,475
36"	24"	1, 2	\$1,608	\$1,762	\$2,037
48"	24"	1, 2	\$1,622	\$1,782	\$2,065
60"	24"	1, 2	\$1,901	\$2,113	\$2,490
66"	24"	1, 2	\$1,909	\$2,123	\$2,505
72"	24"	1, 2	\$1,914	\$2,132	\$2,517
48"	30"	1, 2	\$1,798	\$1,996	\$2,263
60"	30"	1, 2	\$2,152	\$2,430	\$3,053
66"	30"	1, 2	\$2,157	\$2,439	\$3,053
72"	30"	1, 2	\$2,164	\$2,449	\$3,055
48"	36"	1, 2	\$2,117	\$2,404	\$2,910
60"	36"	1, 2	\$2,178	\$2,466	\$2,983
66"	36"	1, 2	\$2,184	\$2,476	\$2,998
72"	36"	1, 2	\$2,191	\$2,486	\$3,060
84"	36"	1, 2	\$2,196	\$2,494	\$3,064
96"	36"	1, 2	\$2,205	\$2,505	\$3,069
60"	42"	1, 2	\$2,341	\$2,632	\$3,147
66"	42"	1, 2	\$2,348	\$2,641	\$3,161
72"	42"	1, 2	\$2,356	\$2,650	\$3,227
84"	42"	1, 2	\$2,363	\$2,660	\$3,232
96"	42"	1, 2	\$2,369	\$2,669	\$3,235
60"	48"	1, 2	\$2,341	\$2,632	\$3,147
66"	48"	1, 2	\$2,348	\$2,641	\$3,161
72"	48"	1, 2	\$2,356	\$2,650	\$3,229
84"	48"	1, 2	\$2,363	\$2,660	\$3,233
96"	48"	1, 2	\$2,369	\$2,669	\$3,237

**ORDER CODE SAMPLE**

LINE 1	TABLE	ITEM CODE	WIDTH	DEPTH	LAMINATE	OPTION
		TMPTT	W60	D24	M1	CC CSR
LINE 1.1	POWER & DATA	POWER OPTION	FINISH / TRIM FINISH / COVER CODE	BODY FINISH / OPTION	POWER QTY	
		AF2AE	BLK	WHT	1	

**Features & Specifications**

No Charge Options  
Optional Extra

- Laminate codes - M1: 1" LPL, H1: 1" HPL, K1: 1.25" knife edge (top only)
- Metal base construction
- Height is 29" nominal, including levellers
- Tables with 60" width and above have anti deflection bar
- Available in all standard laminates and metal finishes
- For 3" curved corners add option code "CC" and \$349
- For hard wheel casters add option code "CSC" and \$110
- For soft wheel casters add option code "CSR" and \$166

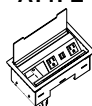
<b>POWER</b>	For detailed specification, cover code finishes, data and telecom options, and pricing of each electrical modules please refer to page "Power & Data Options".		
<b>AF2AE</b> 	<b>Trim Finish:</b> Black (BLK), Silver (SLV), White (WHT)		<b>AT1FE</b> 
	<b>Body Finish:</b> White (WHT), Gray (GRY), Black (BLK), Orange (ORN), Red (RED), Green (GRN), Blue (BLU)		

# York Y Base Meeting & Casual Table

TMPYT

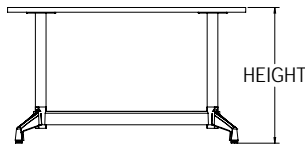
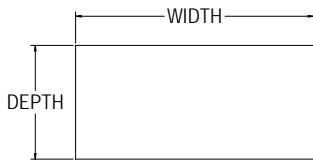
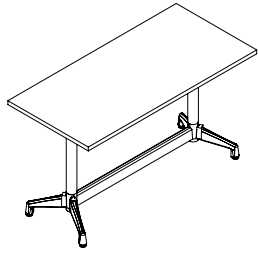

NOMINAL SIZE		POWER	LAMINATE		
WIDTH	DEPTH	QUANTITY	PRICE M1	PRICE H1	PRICE K1
48"	30"	1, 2	\$1,828	\$2,026	\$2,293
60"	30"	1, 2	\$2,766	\$3,044	\$3,667
72"	30"	1, 2	\$2,894	\$3,178	\$3,787
60"	36"	1, 2	\$3,146	\$3,436	\$3,952
72"	36"	1, 2	\$3,178	\$3,475	\$4,046
84"	36"	1, 2	\$3,211	\$3,509	\$4,079
96"	36"	1, 2	\$3,279	\$3,579	\$4,143
60"	42"	1, 2	\$3,296	\$3,586	\$4,101
72"	42"	1, 2	\$3,329	\$3,624	\$4,200
84"	42"	1, 2	\$3,362	\$3,659	\$4,230
96"	42"	1, 2	\$3,427	\$3,730	\$4,296
60"	48"	1, 2	\$3,296	\$3,586	\$4,101
72"	48"	1, 2	\$3,329	\$3,624	\$4,202
84"	48"	1, 2	\$3,362	\$3,659	\$4,232
96"	48"	1, 2	\$3,427	\$3,730	\$4,298



**ORDER CODE SAMPLE**

LINE 1	TABLE	ITEM CODE	WIDTH	DEPTH	LAMINATE	OPTION
		TMPYT	W60	D24	M1	CC CSR
LINE 1.1	POWER & DATA	POWER OPTION	FINISH / TRIM FINISH / COVER CODE	BODY FINISH / OPTION	POWER QTY	
		AF2AE	BLK	WHT	1	

**Features & Specifications**

No Charge Options  
Optional Extra

- Laminate codes - M1: 1" LPL, H1: 1" HPL, K1: 1.25" knife edge (top only)
- Metal base construction
- Stretcher is used for width 60" and above
- Height is 29" nominal, including levellers
- Tables with 60" width and above have anti deflection bar
- Available in all standard laminates and metal finishes
- For 3" curved corners add option code "CC" and \$349
- For hard wheel casters add option code "CSC" and \$110
- For soft wheel casters add option code "CSR" and \$166

<b>POWER</b>	For detailed specification, cover code finishes, data and telecom options, and pricing of each electrical modules please refer to page "Power & Data Options".		
<b>AF2AE</b> 	<b>Trim Finish:</b> Black (BLK), Silver (SLV), White (WHT)		<b>AT1FE</b> 
	<b>Body Finish:</b> White (WHT), Gray (GRY), Black (BLK), Orange (ORN), Red (RED), Green (GRN), Blue (BLU)		

# York T Base, Flip-Top Meeting & Casual Table

TMPFM

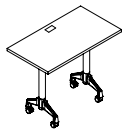
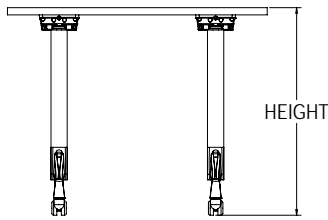
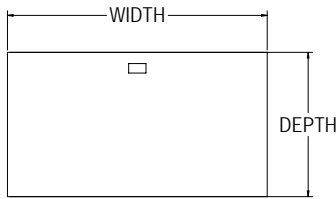
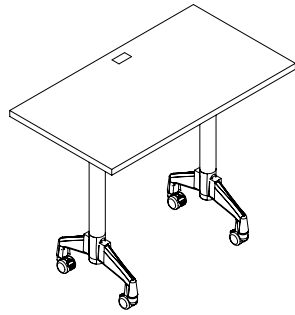

REGULAR

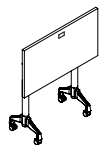

FLIPPED

\* Note: Power option location specific to TMPFM is shown on the line drawings.

**ORDER CODE SAMPLE**

LINE 1	TABLE	ITEM CODE	WIDTH	DEPTH	LAMINATE	OPTION
		TMPFT	W60	D24	M1	CC CSR
LINE 1.1	POWER & DATA	POWER OPTION	FINISH / TRIM FINISH / COVER CODE	BODY FINISH / OPTION	POWER QTY	
		AF2AE	BLK	WHT	1	

**Features & Specifications**

No Charge Options  
Optional Extra

- Laminate codes - M1: 1" LPL, H1: 1" HPL, K1: 1.25" knife edge (top only)
- Metal base construction
- Height is 29" nominal, including levers
- Tables with 60" width and above have anti deflection bar
- Single handle release
- Available in all standard laminates and metal finishes
- For 3" curved corners add option code "CC" and \$349
- For hard wheel casters add option code "CSC" and \$110
- For soft wheel casters add option code "CSR" and \$166

NOMINAL SIZE		POWER	LAMINATE		
WIDTH	DEPTH	QUANTITY	PRICE M1	PRICE H1	PRICE K1
36"	20"	1, 2	\$2,344	\$2,494	\$2,767
48"	20"	1, 2	\$2,357	\$2,514	\$2,794
60"	20"	1, 2	\$2,636	\$2,845	\$3,216
66"	20"	1, 2	\$2,642	\$2,853	\$3,232
72"	20"	1, 2	\$2,648	\$2,863	\$3,245
36"	24"	1, 2	\$2,381	\$2,536	\$2,809
48"	24"	1, 2	\$2,395	\$2,553	\$2,838
60"	24"	1, 2	\$2,672	\$2,884	\$3,261
66"	24"	1, 2	\$2,679	\$2,894	\$3,277
72"	24"	1, 2	\$2,687	\$2,903	\$3,288
48"	30"	1, 2	\$2,568	\$2,769	\$3,035
60"	30"	1, 2	\$2,922	\$3,202	\$3,824
66"	30"	1, 2	\$2,929	\$3,210	\$3,824
72"	30"	1, 2	\$2,935	\$3,221	\$3,828
60"	36"	1, 2	\$2,948	\$3,237	\$3,753
66"	36"	1, 2	\$2,954	\$3,247	\$3,768
72"	36"	1, 2	\$2,962	\$3,257	\$3,830

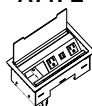
<b>POWER</b>	For detailed specification, cover code finishes, data and telecom options, and pricing of each electrical modules please refer to page "Power & Data Options".		
<b>AF2AE</b> 	<b>Trim Finish:</b> Black (BLK), Silver (SLV), White (WHT)		<b>Finish:</b> Silver (SLV) Only
	<b>Body Finish:</b> White (WHT), Gray (GRY), Black (BLK), Orange (ORN), Red (RED), Green (GRN), Blue (BLU)		

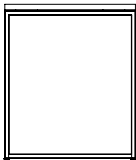
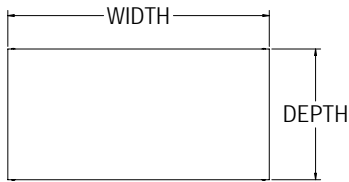
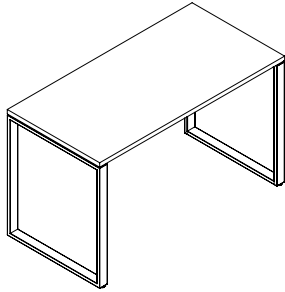

**ORDER CODE SAMPLE**

LINE 1	TABLE	ITEM CODE	WIDTH	DEPTH	LAMINATE
		TDOLT	W60	D24	M1
LINE 1.1	POWER & DATA	POWER OPTION	FINISH / TRIM FINISH / COVER CODE	BODY FINISH / OPTION	POWER QTY
		AF2AE	BLK	WHT	1

**Features & Specifications**

**No Charge Options**

- Laminate codes - M1: 1" LPL, H1: 1" HPL, K1: 1.25" knife edge (top only)
- Metal base construction
- Tables with 60" width and above have anti deflection bar
- Available in all standard laminates and metal finishes

NOMINAL SIZE			POWER	LAMINATE	
WIDTH	DEPTH	HEIGHT	QUANTITY	PRICE M1	PRICE H1
48"	24"	29"	1, 2	\$1,697	\$1,855
60"	24"	29"	1, 2	\$1,841	\$2,053
72"	24"	29"	1, 2	\$1,854	\$2,072
48"	30"	29"	1, 2	\$1,868	\$2,065
60"	30"	29"	1, 2	\$2,085	\$2,366
72"	30"	29"	1, 2	\$2,101	\$2,385

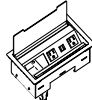
<b>POWER</b>	For detailed specification, cover code finishes, data and telecom options, and pricing of each electrical modules please refer to page "Power & Data Options".		
 <b>AF2AE</b>	<b>Trim Finish:</b> Black (BLK), Silver (SLV), White (WHT)		 <b>AT1FE</b> <b>Finish:</b> Silver (SLV) Only
	<b>Body Finish:</b> White (WHT), Gray (GRY), Black (BLK), Orange (ORN), Red (RED), Green (GRN), Blue (BLU)		

# A Leg Desk

TDALT

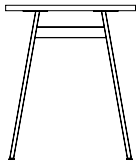
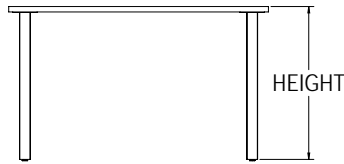
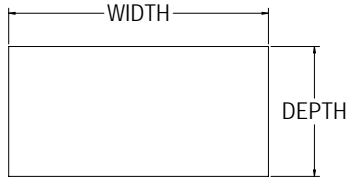
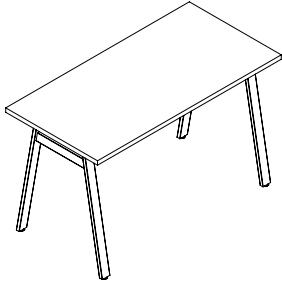

**ORDER CODE SAMPLE**

LINE 1	TABLE	ITEM CODE	WIDTH	DEPTH	LAMINATE
		TDALT	W60	D24	M1
LINE 1.1	POWER & DATA	POWER OPTION	FINISH / TRIM FINISH / COVER CODE	BODY FINISH / OPTION	POWER QTY
		AF2AE	BLK	WHT	1

**Features & Specifications**

**No Charge Options**

- Laminate codes - M1: 1" LPL, H1: 1" HPL, K1: 1.25" knife edge (top only)
- Metal base construction
- Tables with 60" width and above have anti deflection bar
- Available in all standard laminates and metal finishes

NOMINAL SIZE			POWER	LAMINATE	
WIDTH	DEPTH	HEIGHT	QUANTITY	PRICE M1	PRICE H1
48"	24"	29"	1, 2	\$1,697	\$1,855
60"	24"	29"	1, 2	\$1,841	\$2,053
72"	24"	29"	1, 2	\$1,854	\$2,072
48"	30"	29"	1, 2	\$1,868	\$2,065
60"	30"	29"	1, 2	\$2,085	\$2,366
72"	30"	29"	1, 2	\$2,101	\$2,385

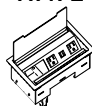
<b>POWER</b>	For detailed specification, cover code finishes, data and telecom options, and pricing of each electrical modules please refer to page "Power & Data Options".		
<b>AF2AE</b> 	<b>Trim Finish:</b> Black (BLK), Silver (SLV), White (WHT)		<b>AT1FE</b> 
	<b>Body Finish:</b> White (WHT), Gray (GRY), Black (BLK), Orange (ORN), Red (RED), Green (GRN), Blue (BLU)		

PRODUCT MAP  
CONFERENCE TABLES  
MEDIA TABLES  
PARSONS TABLES  
MEETING & CASUAL TABLES  
NEST TRAINING TABLES  
www.brc.group

# Trapezoid Base Personal Table

TPLZT

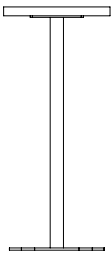
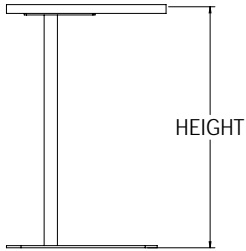
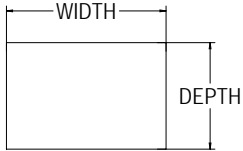
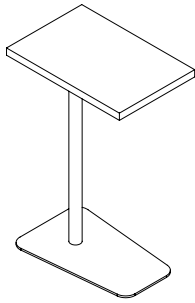

NOMINAL SIZE			LAMINATE		
WIDTH	DEPTH	HEIGHT	PRICE M1	PRICE H1	PRICE K1
18"	12"	26"	\$518	\$627	\$823

**ORDER CODE SAMPLE**

LINE 1	TABLE	ITEM CODE	WIDTH	DEPTH	LAMINATE	OPTION
		TPLZT	W18	D12	M1	CC

**Features & Specifications**

No Charge Options  
Optional Extra

- Laminate codes - M1: 1" LPL, H1: 1" HPL, K1: 1.25" knife edge (top only)
- Metal base construction
- Available in all standard laminates and metal finishes
- For 3" curved corners add option code "CC" and \$349

PRODUCT MAP  
CONFERENCE TABLES  
MEDIA TABLES  
PARSONS TABLES  
MEETING & CASUAL TABLES  
NEST TRAINING TABLES  
www.bic.group

# C Base Personal Table

TPLCT

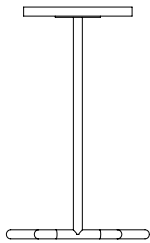
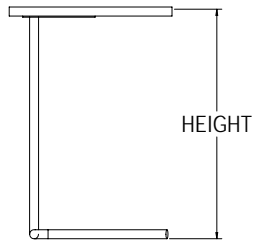
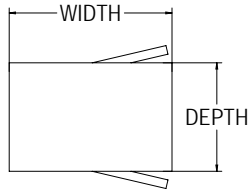
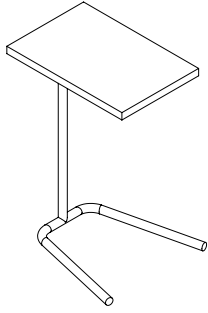

ORDER CODE SAMPLE

NOMINAL SIZE			LAMINATE		
WIDTH	DEPTH	HEIGHT	PRICE M1	PRICE H1	PRICE K1
18"	12"	26"	\$454	\$565	\$761

LINE 1	TABLE	ITEM CODE	WIDTH	DEPTH	LAMINATE	OPTION
		TPLCT	W18	D12	M1	CC

### Features & Specifications

No Charge Options  
Optional Extra

- Laminate codes - M1: 1" LPL, H1: 1" HPL, K1: 1.25" knife edge (top only)
- Metal base construction
- Available in all standard laminates and metal finishes
- For 3" curved corners add option code "CC" and \$349

# Rectangular Base Personal Table

TPLST

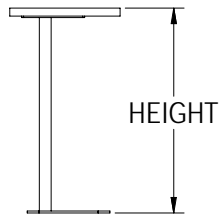
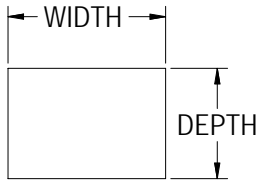
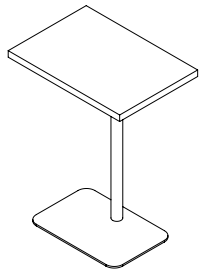

NOMINAL SIZE			LAMINATE		
WIDTH	DEPTH	HEIGHT	PRICE M1	PRICE H1	PRICE K1
20"	16"	26"	\$568	\$707	\$952

**ORDER CODE SAMPLE**

LINE 1	TABLE	ITEM CODE	WIDTH	DEPTH	LAMINATE	OPTION
		TPLST	W20	D18	M1	CC

**Features & Specifications**

No Charge Options  
Optional Extra

- Laminate codes - M1: 1" LPL, H1: 1" HPL, K1: 1.25" knife edge (top only)
- Metal base construction
- Available in all standard laminates and metal finishes
- For 3" curved corners add option code "CC" and \$349

PRODUCT MAP  
CONFERENCE TABLES  
MEDIA TABLES  
PARSONS TABLES  
MEETING & CASUAL TABLES  
NEST TRAINING TABLES  
www.bic.group

# Rectangular Height Adjustable Personal Table

TPADT

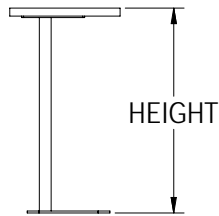
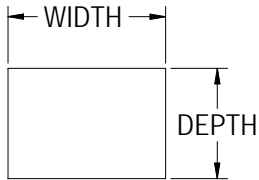
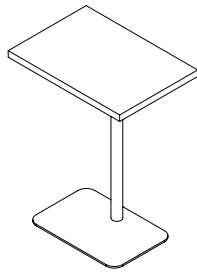

NOMINAL SIZE			LAMINATE		
WIDTH	DEPTH	HEIGHT	PRICE M1	PRICE H1	PRICE K1
20"	16"	23 - 26"	\$918	\$1,057	\$1,302

**ORDER CODE SAMPLE**

LINE 1	TABLE	ITEM CODE	WIDTH	DEPTH	LAMINATE	OPTION
		TPADT	W20	D17	M1	CC

**Features & Specifications**

No Charge Options  
Optional Extra

- Laminate codes - M1: 1" LPL, H1: 1" HPL, K1: 1.25" knife edge (top only)
- Metal base construction
- Available in all standard laminates and metal finishes
- For 3" curved corners add option code "CC" and \$349

# Round Ottoman

TTMRN

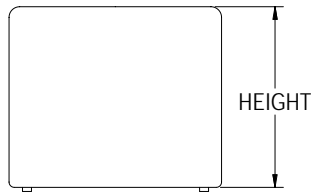
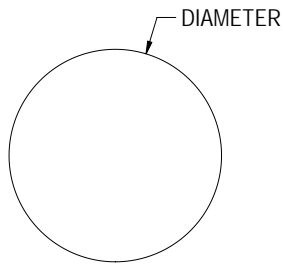
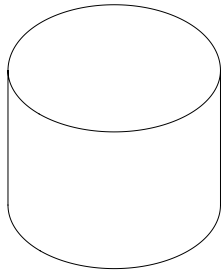

NOMINAL SIZE		PRICE		
DIAMETER	HEIGHT	GRADE 1	GRADE 2	GRADE 2
16"	17"	860	1,005	1,150
18"	17"	879	1,011	1,163
22"	17"	995	1,190	1,350
24"	17"	1,087	1,250	1,439
30"	17"	1,142	1,313	1,511
36"	17"	1,199	1,379	1,588
42"	17"	1,259	1,449	1,667
48"	17"	1,323	1,521	1,751

**ORDER CODE SAMPLE**

LINE 1	OTTOMAN	ITEM CODE	DIAMETER	HEIGHT	GRADE
		TTMRN	D24	H17	G1

**Features & Specifications**

- Fully upholstered top and sides
- Includes lellers

**No Charge Options**

- Available in all standard grade 1, 2 and 3 seating fabrics. Specify G1, G2 or G3

# Square Ottoman

TTMSN

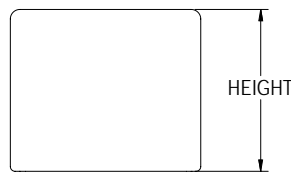
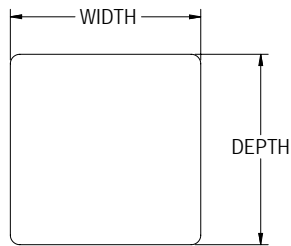
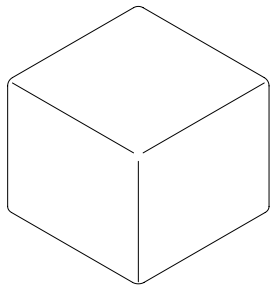

NOMINAL SIZE			PRICE		
WIDTH	DEPTH	HEIGHT	GRADE 1	GRADE 2	GRADE 2
16"	16"	17"	835	960	1,115
18"	18"	17"	849	977	1,124
22"	22"	17"	962	1,145	1,290
24"	24"	17"	1,050	1,208	1,390
30"	30"	17"	1,104	1,269	1,460
36"	36"	17"	1,159	1,332	1,534
42"	42"	17"	1,217	1,400	1,611
48"	48"	17"	1,278	1,470	1,692

**ORDER CODE SAMPLE**

LINE 1	OTTOMAN	ITEM CODE	WIDTH	DEPTH	HEIGHT	GRADE
		TTMSN	W24	D24	H17	G1

**Features & Specifications**

- Fully upholstered top and sides
- Includes lellers

**No Charge Options**

- Available in all standard grade 1, 2 and 3 seating fabrics. Specify G1, G2 or G3

# Casual Bench

TTBCN

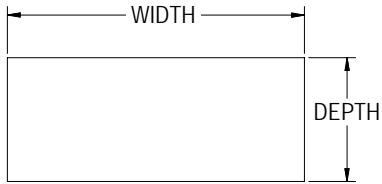
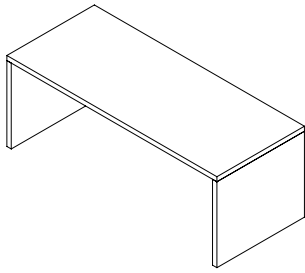

NOMINAL SIZE			PRICE			
WIDTH	DEPTH	HEIGHT	NO FABRIC	GRADE 1	GRADE 2	GRADE 2
30"	20"	18"	475	+588	+661	+763
36"	20"	18"	492	+609	+682	+784
42"	20"	18"	535	+630	+702	+803
48"	20"	18"	590	+687	+766	+876
54"	20"	18"	625	+770	+858	+982
60"	20"	18"	662	+863	+961	+1,100
66"	20"	18"	685	+967	+1,077	+1,233
72"	20"	18"	705	+1,084	+1,207	+1,381

**ORDER CODE SAMPLE**

LINE 1	BENCH	ITEM CODE	WIDTH	DEPTH	HEIGHT	FABRIC GRADE	STITCH
		TTBCN	W60	D20	H18	G1	BX

**Features & Specifications**

- 1" LPL Construction
- Available as laminate bench only or with 1" fabric cushion

**No Charge Options**

- Available in all standard laminates

**Optional Extra**

- Optional cushion available in all standard grade 1, 2 and 3 seating fabrics. Specify G1, G2 or G3
- Specify 'BX' for box style stitch or 'ST' for saddle stitch

PRODUCT MAP  
CONFERENCE TABLES  
MEDIA TABLES  
PARSONS TABLES  
MEETING & CASUAL TABLES  
NEST TRAINING TABLES  
www.bic.group

# Training Tables



BRC launches our most versatile table for conference, training, cafeteria or breakrooms where mobility is crucial - introducing BRC Training Tables. Training Tables deliver outstanding value with standard locking casters, one handed flipping mechanism and a one inch thick LPL or HPL worksurface. Each frame is designed so that multiple tables can be nested together and stored easily out of the way ready for the next conference or training session. For flexibility, training tables are available with surface mounted power options or robust daisy chain power allowing multi-unit connection from a single source.

# Nest Training Table

TNSTM

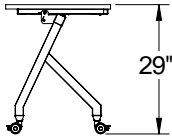
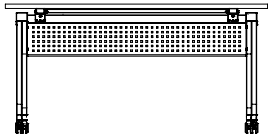
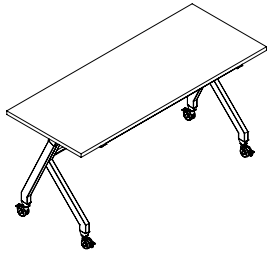

NOMINAL SIZE			LAMINATE	
WIDTH	DEPTH	HEIGHT	PRICE M1	PRICE H1
60"	24"	29.5"	\$1,103	\$1,303
60"	30"	29.5"	\$1,350	\$1,618
72"	24"	29.5"	\$1,115	\$1,321
72"	30"	29.5"	\$1,350	\$1,622

**ORDER CODE SAMPLE**

LINE 1	TABLE	ITEM CODE	WIDTH	DEPTH	LAMINATE	OPTION
		TNSTM	W60	D24	M1	TGNGA

**Features & Specifications**

**No Charge Options**

**Optional Extra**

- Laminate codes - M1: 1" LPL, H1: 1" HPL (top only)
- Metal flip top base & integrated modesty available in white only
- Includes 3" twin wheel locking casters & 11.5" high metal modesty
- Worksurface available in all standard laminates
- One set of table ganging brackets, add code 'TGNGA' and \$45

# MidWest Rectangular Training Table

TWMSM

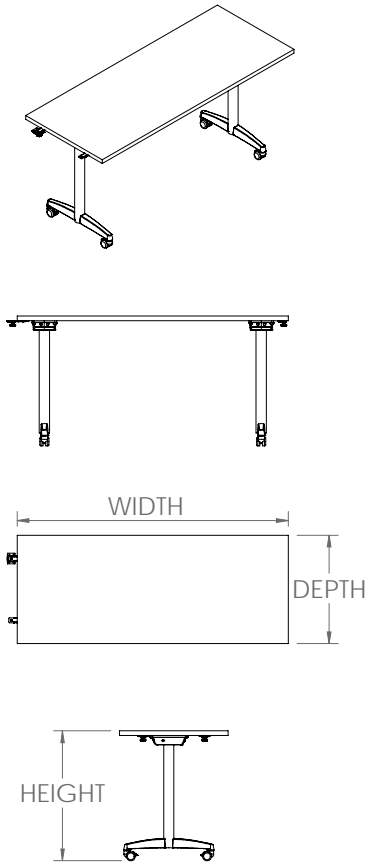

NOMINAL SIZE			LAMINATE	
WIDTH	DEPTH	HEIGHT	PRICE M1	PRICE H1
36"	24"	29"	\$2,226	\$2,630
36"	30"	29"	\$2,724	\$3,265
36"	36"	29"	\$2,860	\$3,428
48"	24"	29"	\$2,271	\$2,683
48"	30"	29"	\$2,779	\$3,331
48"	36"	29"	\$2,918	\$3,497
60"	24"	29"	\$2,317	\$2,737
60"	30"	29"	\$2,835	\$3,398
60"	36"	29"	\$2,977	\$3,568
72"	24"	29"	\$2,342	\$2,775
72"	30"	29"	\$2,835	\$3,407
72"	36"	26"	\$2,977	\$3,578

**ORDER CODE SAMPLE**

LINE 1	TABLE	ITEM CODE	WIDTH	DEPTH	LAMINATE	OPTION
		TWMSM	W60	D24	M1	TGNGA

**Features & Specifications**

**No Charge Options**

**Optional Extra**

- Laminate codes - M1: 1" LPL, H1: 1" HPL (top only)
- Cast metal base construction
- Worksurface available in all standard laminates
- One set of table ganging brackets, add code 'TGNGA' and \$45

PRODUCT MAP  
CONFERENCE TABLES  
MEDIA TABLES  
PARSONS TABLES  
MEETING & CASUAL TABLES  
NEST TRAINING TABLES  
www.brc.group

# MidWest Halfmoon Training Table

TWMDM

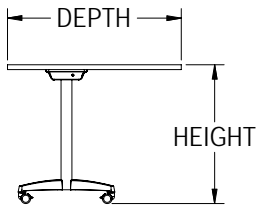
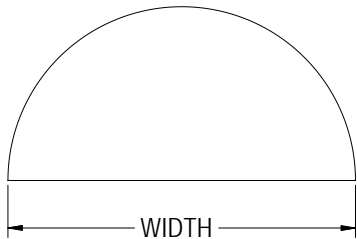
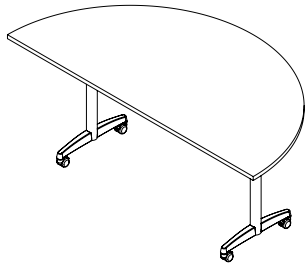

NOMINAL SIZE			LAMINATE	
WIDTH	DEPTH	HEIGHT	PRICE M1	PRICE H1
48"	24"	29"	\$2,499	\$2,952
60"	30"	29"	\$3,119	\$3,738
72"	36"	26"	\$3,275	\$3,936

**ORDER CODE SAMPLE**

LINE 1	TABLE	ITEM CODE	WIDTH	DEPTH	LAMINATE	OPTION
		TWMDM	W60	D30	M1	TGNGA

**Features & Specifications**

**No Charge Options**

**Optional Extra**

- Laminate codes - M1: 1" LPL, H1: 1" HPL (top only)
- Cast metal base construction
- Worksurface available in all standard laminates
- One set of table ganging brackets, add code 'TGNGA' and \$45

PRODUCT MAP

CONFERENCE TABLES

MEDIA TABLES

PARSONS TABLES

MEETING & CASUAL TABLES

NEST TRAINING TABLES

www.bic.group

# Nest Training Table with Power

TNSPM

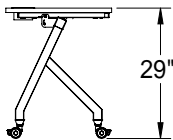
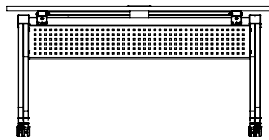
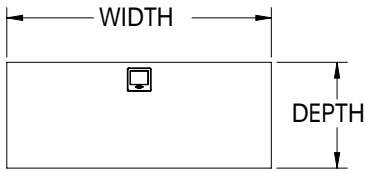
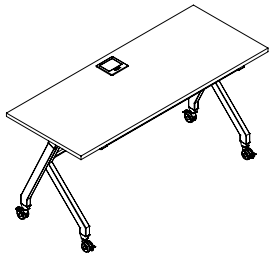

NOMINAL SIZE			LAMINATE	
WIDTH	DEPTH	HEIGHT	PRICE M1	PRICE H1
60"	24"	29.5"	\$1,166	\$1,367
60"	30"	29.5"	\$1,415	\$1,681
72"	24"	29.5"	\$1,179	\$1,386
72"	30"	29.5"	\$1,415	\$1,685

**ORDER CODE SAMPLE**

LINE 1	TABLE	ITEM CODE	WIDTH	DEPTH	LAMINATE	OPTION
		TNSPM	W60	D24	M1	TGNGA
LINE 1.1	POWER & DATA	POWER OPTION	FINISH / TRIM FINISH / COVER CODE	BODY FINISH / OPTION	POWER QTY	
		AT1FE				

**Features & Specifications**

No Charge Options  
Optional Extra

- Laminate codes - M1: 1" LPL, H1: 1" HPL (top only)
- Metal flip top base & integrated modesty available in white only
- Includes 3" twin wheel locking casters & 11.5" high metal modesty
- Prices above include Nest table & power module cut out only, refer to the following page for power module options and prices
- Worksurface available in all standard laminates
- One set of table ganging brackets, add code 'TGNGA' and \$45

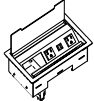
OPTIONAL POWER	For detailed specification, cover code finishes, data and telecom options, and pricing of each electrical modules please refer to the following page	
 <p><b>AL4BE</b></p> <p><b>Finish:</b> Black (BLK) Only</p> <p>Note: power bar supplied without worksurface grommet</p>	 <p><b>AT1FE</b></p> <p><b>Finish:</b> Silver (SLV) Only</p>	

# Power Options: Nest Training Tables

## AL4BE: Undermount Power Strip

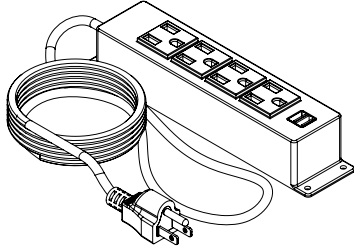

AL4BE	
FEATURES & SPECIFICATIONS	PRICE
<ul style="list-style-type: none"> <li>• 4 Outlet power bar with 2 USB charging ports</li> <li>• Easy surface mounting tabs</li> <li>• 15' Power cord</li> <li>• 15 Amp</li> <li>• Black plastic housing</li> <li>• Note, power bar supplied without worksurface grommet</li> </ul>	\$77

## AT1FE: Top Mount Tilting

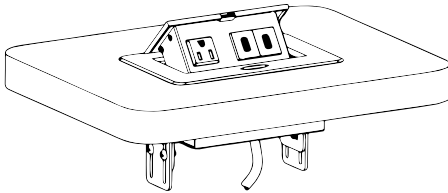

AT1FE	
FEATURES & SPECIFICATIONS	PRICE
<ul style="list-style-type: none"> <li>• Single outlet</li> <li>• 2 USB charging ports with separate power adapter</li> <li>• Push button tilting mechanism</li> <li>• 96" black power cable</li> <li>• Finish options: silver only</li> </ul>	\$520

### ORDER CODE SAMPLE

LINE 1	TABLE	ITEM CODE	WIDTH	DEPTH	LAMINATE	OPTION
		TNSPM	W60	D24	M1	TGNGA
LINE 1.1	POWER & DATA	POWER OPTION	FINISH / TRIM FINISH / COVER CODE	BODY FINISH / OPTION	POWER QTY	
		AT1FE				

# MidWest Training Table with Power

TWMPM

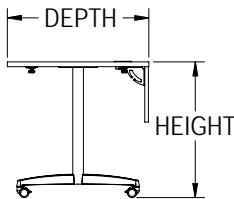
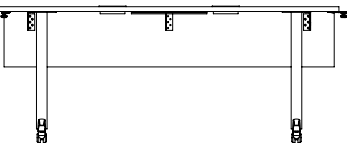
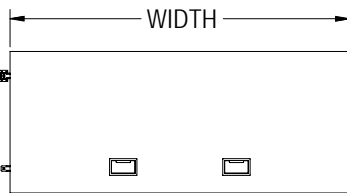
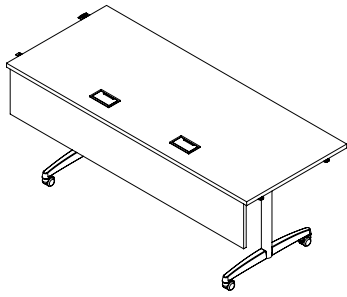

NOMINAL SIZE				LAMINATE	
WIDTH	DEPTH	HEIGHT	POWER QTY	PRICE M1	PRICE H1
36"	24"	29"	1	\$2,299	\$2,694
36"	30"	29"	1	\$2,790	\$3,314
36"	36"	29"	1	\$2,930	\$3,479
48"	24"	29"	1	\$2,345	\$2,748
48"	30"	29"	1	\$2,846	\$3,381
48"	36"	29"	1	\$2,989	\$3,550
57"	24"	29"	1	\$2,392	\$2,804
57"	30"	29"	1	\$2,904	\$3,449
57"	36"	29"	1	\$3,050	\$3,622
60"	24"	29"	1	\$2,392	\$2,804
60"	30"	29"	1	\$2,904	\$3,449
60"	36"	29"	1	\$3,050	\$3,622
72"	24"	29"	1 or 2	\$2,419	\$2,844
72"	30"	29"	1 or 2	\$2,904	\$3,458
72"	36"	29"	1 or 2	\$3,050	\$3,631

**ORDER CODE SAMPLE**

LINE 1	TABLE	ITEM CODE	WIDTH	DEPTH	LAMINATE	OPTION
		TWMPM	W60	D24	M1	TGNGA
LINE 1.1	POWER & DATA	POWER OPTION	BASE FINISH CODE	COVER FINISH CODE	OPTION	
		ADV1E	BLK	F-AL	C	

**Features & Specifications**

No Charge Options  
Optional Extra

- Laminate codes - M1: 1" LPL, H1: 1" HPL (top only)
- Prices above include table & power module cut out only. Indicate ADV1E for single power and ADV2E for double power modules
- Includes fixed modesty & cast metal base construction
- Worksurface available in all standard laminates
- One set of table ganging brackets, add code 'TGNGA' and \$45

**POWER & DATA** For detailed specification, cover code finishes, data and telecom options, and pricing of each electrical modules please refer to page "Power & Data Options".

ADV1E	Base Finish Code: <i>BLK, SLV</i>	ADV2E	Base Finish Code: <i>BLK, SLV</i>
	Cover Finish Code: F-AL, F-S, F-B, F-W		Cover Finish Code: F-AL, F-S, F-B, F-W
	Option (Data & Telecom): C		Option (Data & Telecom): C

PRODUCT MAP  
CONFERENCE TABLES  
MEDIA TABLES  
PARSONS TABLES  
MEETING & CASUAL TABLES  
NEST TRAINING TABLES  
www.brc.group

# MidWest End V Training Table with Power

TWEVM

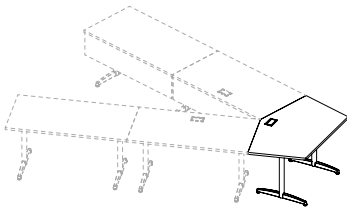
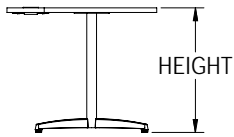
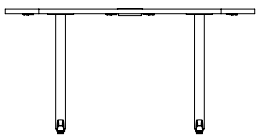
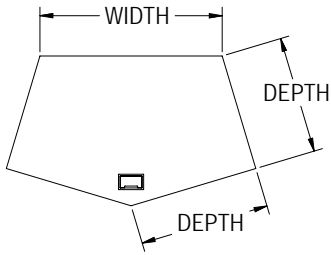
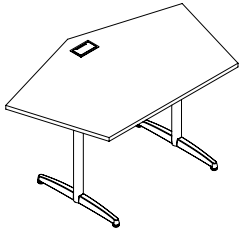

NOMINAL SIZE				LAMINATE	
WIDTH	DEPTH	HEIGHT	POWER QTY	PRICE M1	PRICE H1
36"	24"	29"	1	\$2,362	\$2,790
42"	27.25"	29"	1	\$2,948	\$3,533

**ORDER CODE SAMPLE**

LINE 1	TABLE	ITEM CODE	WIDTH	DEPTH	LAMINATE	OPTION
		TWEVM	W42	D30	M1	TGNGA
LINE 1.1	POWER & DATA	POWER OPTION	BASE FINISH CODE	COVER FINISH CODE	OPTION	
		ADV1E	BLK	F-AL	C	

**Features & Specifications**

**No Charge Options**

**Optional Extra**

- Laminate codes - M1: 1" LPL, H1: 1" HPL (top only)
- Prices above include table & power module cut out only.
- Cast metal base construction
- Worksurface available in all standard laminates
- One set of table ganging brackets, add code 'TGNGA' and \$45

**POWER & DATA** For detailed specification, cover code finishes, data and telecom options, and pricing of each electrical modules please refer to page "Power & Data Options".

<p><b>ADV1E</b></p>	<b>Base Finish Code:</b> BLK, SLV
	<b>Cover Finish Code:</b> F-AL, F-S, F-B, F-W
	<b>Option (Data &amp; Telecom):</b> C

PRODUCT MAP  
CONFERENCE TABLES  
MEDIA TABLES  
PARSONS TABLES  
MEETING & CASUAL TABLES  
NEST TRAINING TABLES  
www.brc.group

# MidWest Halfmoon Training Table with Power

TWMZM

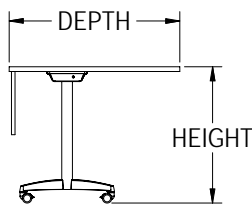
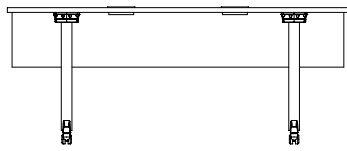
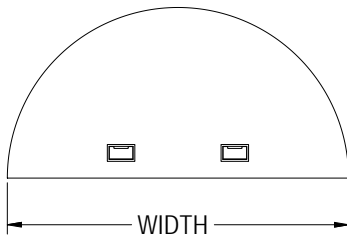
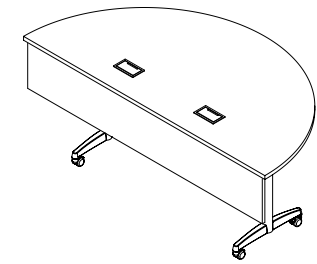

NOMINAL SIZE				LAMINATE	
WIDTH	DEPTH	HEIGHT	POWER QTY	PRICE M1	PRICE H1
48"	24"	29"	1	\$2,624	\$3,100
60"	30"	29"	1	\$3,275	\$3,925
72"	36"	26"	1 or 2	\$3,439	\$4,133

**ORDER CODE SAMPLE**

LINE 1	TABLE	ITEM CODE	WIDTH	DEPTH	LAMINATE	OPTION
		TWMZM	W60	D24	M1	TGNGA
LINE 1.1	POWER & DATA	POWER OPTION	BASE FINISH CODE	COVER FINISH CODE	OPTION	
		ADV1E	BLK	F-AL	C	

**Features & Specifications**

No Charge Options  
Optional Extra

- Laminate codes - M1: 1" LPL, H1: 1" HPL (top only)
- Prices above include table & power module cut out only. Indicate ADV1E for single power and ADV2E for double power modules
- Includes fixed modesty & cast metal base construction
- Worksurface available in all standard laminates
- One set of table ganging brackets, add code 'TGNGA' and \$45

POWER & DATA	For detailed specification, cover code finishes, data and telecom options, and pricing of each electrical modules please refer to page "Power & Data Options".	
<p><b>ADV1E</b></p>	Base Finish Code: <i>BLK, SLV</i>	<p><b>ADV2E</b></p>
	Cover Finish Code: F-AL, F-S, F-B, F-W	
	Option (Data & Telecom): C	
	Base Finish Code: <i>BLK, SLV</i>	
	Cover Finish Code: F-AL, F-S, F-B, F-W	
	Option (Data & Telecom): C	

PRODUCT MAP  
CONFERENCE TABLES  
MEDIA TABLES  
PARSONS TABLES  
MEETING & CASUAL TABLES  
NEST TRAINING TABLES  
www.brc.group

# Power & Data Options: MidWest Training Tables

## ADV1E: Villa Single Undermount

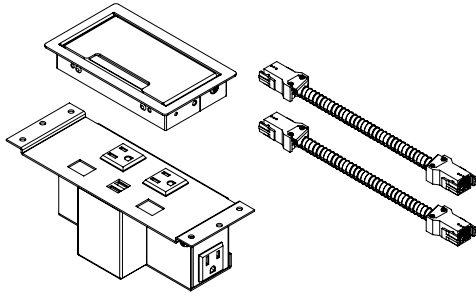

ADV1E	
FEATURES & SPECIFICATIONS	PRICE
<ul style="list-style-type: none"> <li>Includes single power unit, cover, FF cable &amp; FM cable</li> <li>Two power outlets per unit</li> <li>Two USB charging ports per unit</li> <li>Base finish options: black or silver</li> <li>Select cover finish below and add upcharge</li> <li>For infeed cable, add product <b>ADPIE</b></li> </ul>	778

## ADV2E: Villa Double Undermount

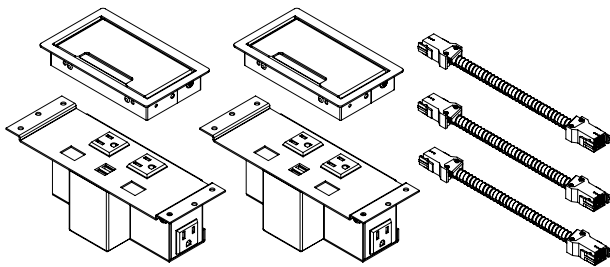

ADV2E	
FEATURES & SPECIFICATIONS	PRICE
<ul style="list-style-type: none"> <li>Includes two power units, two covers, two FF cables &amp; one FM cable</li> <li>Two power outlets per unit</li> <li>Two USB charging ports per unit</li> <li>Base finish options: black or silver</li> <li>Select cover finish below and add upcharge</li> <li>For infeed cable, add product <b>ADPIE</b></li> </ul>	1,366

BASE FINISH		
MODEL	FINISH	PRICE
BLK	BLACK PAINT	INCLUDED
SLV	SILVER PAINT	INCLUDED

COVER FINISH		
MODEL	FINISH	PRICE
F-AL	BRUSHED ALUMINUM	ADD 464
F-S	SILVER PAINT	ADD 233
F-B	BLACK PAINT	ADD 233
F-W	GLOSS WHITE PAINT	ADD 233

OPTION	FEATURE(S)	PRICE
C	 (2) RJ45 CAT6	ADD 422

### ORDER CODE SAMPLE

LINE 1	TABLE	ITEM CODE	WIDTH	DEPTH	LAMINATE	OPTION
		TFRTT	W276	D48	M1	CC
LINE 1.1	POWER & DATA	POWER OPTION	BASE FINISH CODE	COVER FINISH CODE	OPTION	
		ADV1E	BLK	F-AL	C	

# Nest Training Table with Daisy Chain Power

TNSDM

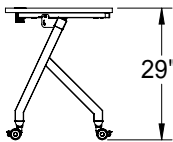
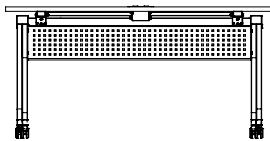
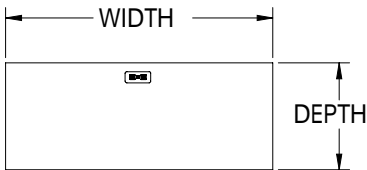

NOMINAL SIZE			LAMINATE	
WIDTH	DEPTH	HEIGHT	PRICE M1	PRICE H1
60"	24"	29.5"	\$1,759	\$1,961
60"	30"	29.5"	\$2,007	\$2,275
72"	24"	29.5"	\$1,772	\$1,979
72"	30"	29.5"	\$2,007	\$2,280

**ORDER CODE SAMPLE**

LINE 1	TABLE	ITEM CODE	WIDTH	DEPTH	LAMINATE	OPTION
		TNSDM	W60	D24	M1	TGNGA
LINE 1.1	POWER & DATA	POWER OPTION	FINISH / TRIM FINISH / COVER CODE	BODY FINISH / OPTION	POWER QTY	
		S				

**Features & Specifications**

No Charge Options

Optional Extra

- Laminate codes - M1: 1" LPL, H1: 1" HPL (top only)
- Metal flip top base & integrated modesty available in white only
- Includes 3" twin wheel locking casters & 11.5" high metal modesty
- Clamp mount daisylink is available in Silver (S), Black (B), and White (W)
- Prices above include Nest table & flush mount Daisy Chain 2 power, 2 USB module. Refer to the following page for infeeds and interconnecting cables
- Worksurface available in all standard laminates
- One set of table ganging brackets, add code 'TGNGA' and \$45

<b>INCLUDED POWER</b>		<p>This Nest table includes a flush mount Daisy Chain power module with 2 power outlets and 2 USB charging ports. Refer to the following page for connecting accessories</p> <p>Finish: Silver, Black &amp; White</p>
---------------------------	--	---

# Daisy Chain Power Module Accessories

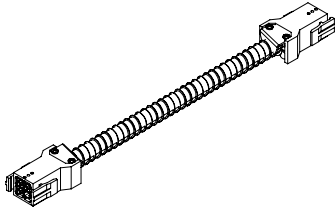

ORDER CODE		
MODEL	LENGTH	PRICE
ADFFE	36"	\$146
ADFFE	42"	\$154
ADFFE	48"	\$164
ADFFE	54"	\$173
ADFFE	58"	\$178
ADFFE	64"	\$188
ADFFE	70"	\$197

FEATURES & SPECIFICATIONS
<ul style="list-style-type: none"> <li>Female/Female interconnecting cable</li> </ul>

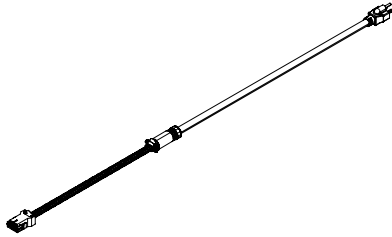

ADPIE	
FEATURES & SPECIFICATIONS	PRICE
<ul style="list-style-type: none"> <li>Power infeed 3 prong - single circuit</li> <li>Length: 72"</li> </ul>	\$281

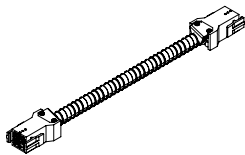

ADFNE	
FEATURES & SPECIFICATIONS	PRICE
<ul style="list-style-type: none"> <li>Female/Male interconnecting cable extension</li> <li>Length: 36"</li> </ul>	\$185

## ORDER CODE SAMPLE

LINE 1	ITEM CODE	LENGTH
	ADFFE	42"

## Features & Specifications

- Metal shielded cables



Need Help? For assistance with specifying and configuring your layout, contact BRC.

# Nest Training Table with Daisy Chain Power Configurations

## Summary

The Nest Table with Daisy Chain power includes a flush mounted 2 power, 2 USB module. To power the table(s), optional accessories are required based on customer requirements. A power infeed and Interconnecting cables are available in several sizes at additional cost. Refer to the previous page for ordering and pricing. The daisy chain power modules supplied by BRC are capable of connecting up to 5 tables on one circuit.

## Sample Layouts:

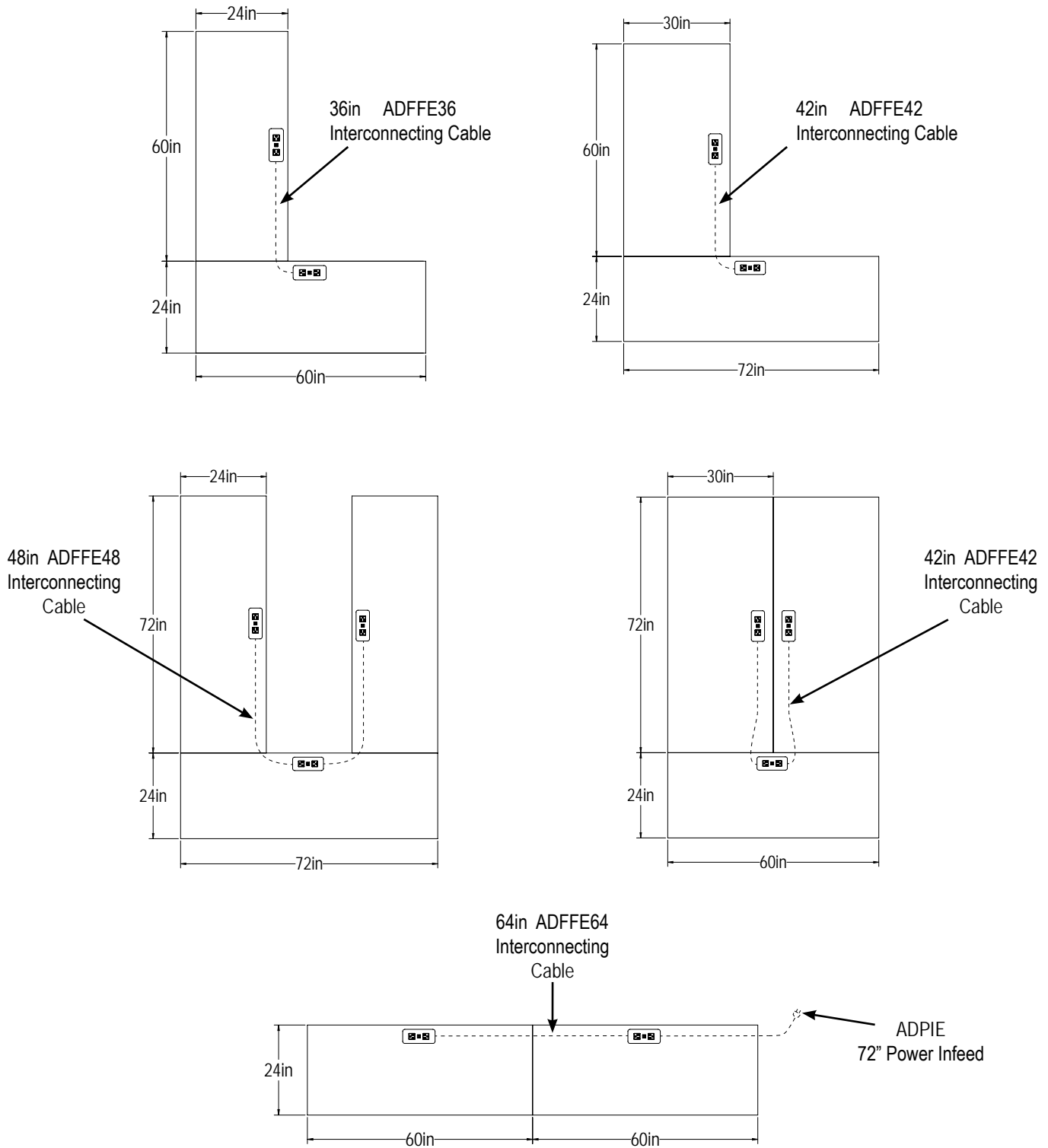

# Connect Ganging Table Bracket Set

TGNGA

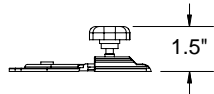
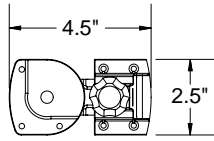
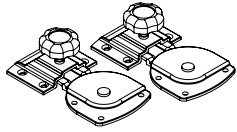

NOMINAL SIZE			
WIDTH	DEPTH	HEIGHT	PRICE
4.5"	2.5"	1.5"	\$45

**ORDER CODE SAMPLE**

<b>LINE 1</b>	ITEM CODE
	TGNGA

**Features & Specifications**

- No tools required for operation after installation
- Includes one set as shown
- Finished in black



When ganging is required with any Nest Table, order the ganging brackets as an option with the table. This provides pre-drilled holes for the brackets and makes installation much easier.

PRODUCT MAP  
CONFERENCE TABLES  
MEDIA TABLES  
PARSONS TABLES  
MEETING & CASUAL TABLES  
NEST TRAINING TABLES  
www.brc.group

For sales information contact: [quotes@brc.group](mailto:quotes@brc.group)

24 Armstrong Ave  
Georgetown, ON L7G 4R9  
Phone: 905.873.8509  
Toll Free: 1.877.260.4309  
[info@brc.group](mailto:info@brc.group)

